

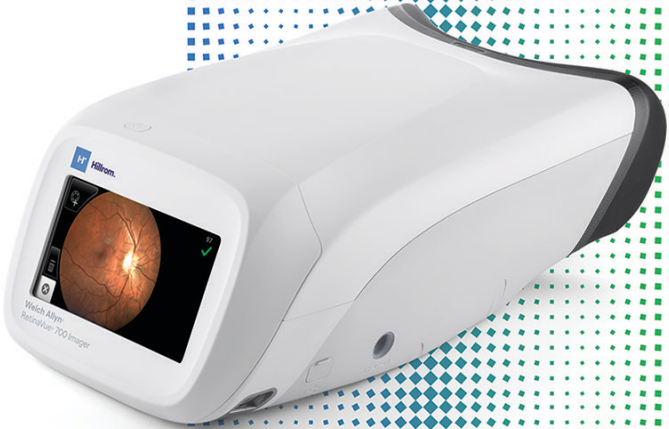

Hillrom™

Welch Allyn®
RetinaVue® 700 Imager



Instructions for use

Software version 1.60.XX

© 2022 Welch Allyn. All rights are reserved. To support the intended use of the product described in this publication, the purchaser of the product is permitted to copy this publication, for internal distribution only, from the media provided by Welch Allyn. No other use, reproduction, or distribution of this publication, or any part of it, is permitted without written permission from Welch Allyn.

Legal Statement. Welch Allyn, Inc. ("Welch Allyn") assumes no responsibility for any injury to anyone that may result from (i) failure to properly use the product in accordance with the instructions, cautions, warnings, or statement of intended use published in this manual, or (ii) any illegal or improper use of the product.

Welch Allyn and RetinaVue are registered trademarks of Welch Allyn, Inc.

Software in this product is Copyright 2022 Welch Allyn, Inc. or its vendors. All rights are reserved. The software is protected by United States of America copyright laws and international treaty provisions applicable worldwide. Under such laws, the licensee is entitled to use the copy of the software incorporated with this instrument as intended in the operation of the product in which it is embedded. The software may not be copied, decompiled, reverse-engineered, disassembled, or otherwise reduced to human-perceivable form. This is not a sale of the software or any copy of the software; all right, title, and ownership of the software remain with Welch Allyn or its vendors.

This product may contain software known as "free" or "open source" software (FOSS). Hill-Rom uses and supports the use of FOSS. We believe that FOSS makes our products more robust and secure, and gives us and our customers greater flexibility. To learn more about FOSS that may be used in this product, please visit our FOSS website at hillrom.com/opensource. Where required, a copy of FOSS source code is available on our FOSS website.

PATENTS / PATENT hillrom.com/patents.

May be covered by one or more patents. See above Internet address. The Hill-Rom companies are the proprietors of European, US, and other patents and pending patent applications.

For information about any product, contact Hillrom Technical Support: hillrom.com/en-us/about-us/locations/.



775673
80030073 Ver. A
Revision date: 2022-11

Distributed by Welch Allyn, Inc.
4341 State Street Road
Skaneateles Falls, NY 13153 USA
Welch Allyn, Inc. is a subsidiary of Hill-Rom Holdings, Inc.

hillrom.com



Medimaging Integrated Solution Inc. (MiiS)
3F, No. Industry E. Rd. IV,
Hsinchu Science Park,
Hsinchu, Taiwan
30077, R.O.C.

Made in Taiwan

This manual applies to the



901124 Ophthalmic Camera
Authorized Australian Sponsor
Welch Allyn Australia Pty Limited
1 Baxter Drive
Old Toongabbie NSW 2146
Australia

R_x ONLY



Contents

Symbols	1
Introduction	5
Intended use	5
About warnings and cautions	5
General warnings, cautions, and notes	6
Controls and connectors	11
First time set up of the RetinaVue 700 Imager	13
Unpack the system	13
Startup	18
First time selection of practice mode	24
Camera registration	27
USB camera registration	27
Wi-Fi camera registration	29
Advanced camera registration	37
Static IP Wi-Fi camera registration	37
FIPS Wi-Fi camera registration	44
Using the RetinaVue 700 Imager	47
Auto exam mode	47
About image quality scores	49
About the face cup	49
About Exam protocols	51
Tutorial	53
Before starting an eye exam	54
Perform a retina eye exam	57
Create a patient on the camera	64
Search for a patient in the Scheduled patients list	65
Search for a patient in the Saved exams list	67
Delete an image during an eye exam	70

- Delete a patient 72
- Delete a patient and exam 73
- Capture additional images using the same protocol 76
- Review of saved exams 77
- Review of submitted exams 78
- Update the RetinaVue 700 Imager software (firmware) 80
- Install firmware when scheduled on the RetinaVue 700 Imager 82

- Controls 85**
 - RetinaVue 700 Imager main Patients screen 85
 - Practice mode 89
 - Select or change a clinic on the RetinaVue 700 Imager (wireless only) 95
 - Select or change a Multi-State clinic on the RetinaVue 700 Imager (wireless only) 97
 - View or change the RetinaVue 700 Imager settings 98

- Advanced features 119**
 - Manual exam mode 119
 - Use the Anterior Imaging Spacer for a patient Anterior image exam 125
 - Perform an Anterior image eye exam 127
 - Enable NTP for automatic date and time 132
 - Adjust wait time between image captures 133
 - Wireless certificate support overview for the IT department 134

- Troubleshooting 137**
 - Wireless radio messages 143

- Maintenance 149**
 - Cleaning and disinfection 149

- Specifications 155**

- Device radio 159**

- General compliance and standards 161**
 - General radio compliance 162

- RetinaVue 700 Imager accessories 171**

- Warranty 175**

Symbols

Documentation symbols

For information on the origin of these symbols, visit <https://www.hillrom.com/content/dam/hillrom-aem/us/en/sap-documents/LIT/80022/80022945LITPDF.pdf> for the Welch Allyn® symbols glossary.



WARNING The warning statements in this manual identify conditions or practices that could lead to illness, injury, or death. Warning symbols will appear with a grey background in a black and white document.



Caution The caution statements in this manual identify conditions or practices that could result in damage to the equipment or other property, or loss of data.



Consult instructions for use.

Power symbols



Power button



Direct current (DC)



Rated power input, DC



Rated power output, DC



Fuse



Rechargeable battery

Li-ion

Connectivity symbols



USB



Wireless

Wireless radio symbols



Non-ionizing electromagnetic radiation



Wireless signal strength

- Best (4 bars)
- Good (3 bars)
- Fair (2 bars)
- Weak (1 bar)
- No signal (no bars)

FCC ID



The identification number assigned by the Federal Communication Commission



Australian Communications and Media Authority (ACMA) Radio Compliance Mark (RCM)







Shipping, storing, and environment symbols











Temperature limit







Keep Dry







	Separate collection of Electrical and Electronic Equipment. Do not dispose as unsorted municipal waste.
	Fragile
	Humidity limitation
	Atmospheric pressure limitation
	This way up
	Stacking limit by number
	Recyclable

Miscellaneous symbols

	Reorder Number
	Product Identifier
	Global Trade Item Number
	For indoor use only
	Type BF applied part
	Class II equipment
	Prescription only or "For Use by or on the order of a licensed medical professional"
	Clock; time switch; timer

	Serial Number
	Manufacturer
	Call for maintenance
	Medical Device
	Process indicator for activities like connecting to network or connecting to computer

Battery charge level indicators

	Device is running on battery and charge is between 75 and 100 percent.
	Device is running on battery and charge is below 75 percent.
	Device is running on battery and charge is below 50 percent.
	Device is running on battery and charge is below 25 percent.
	Device is running on battery and charge is near 0 percent.
	Device is connected to a power supply.

Introduction

Intended use

The Welch Allyn RetinaVue® 700 Imager (RV700) is a high-resolution ophthalmic camera used to acquire, save and transmit digital images of the human eye. Anterior and posterior ocular structures such as the surface of the eye, cornea, and fundus including retina, macula and optic disc can be imaged. It is a prescription use only medical device.

About warnings and cautions

The RetinaVue 700 Imager system includes the camera and any related applications or servers. Please read all instructions for use to ensure you understand all related warnings. Please also read any relevant information on the packaging and shipping container.

The RetinaVue 700 Imager is safe for patients and clinicians when used in accordance with the instructions and the warning and caution statements presented in this *Instructions for use*.

Before using the device, you must familiarize yourself with all warnings and cautions, with the steps to power up the device, and with the sections of this *Instructions for use* that pertain to your use of the device. Specific warnings and cautions are also found throughout this manual.

- Failure to understand and observe any warning statement in this manual could lead to patient injury or illness.
- Failure to understand and observe any caution statement in this manual could lead to damage to the equipment or other property, or loss of patient data.

General warnings, cautions, and notes



WARNING When manually entering patient information, do not use the same patient identifier for multiple patients. This may result in inaccurate data association.



WARNING Operating the device in the presence of a flammable anesthetic mixture with air, oxygen, or nitrous oxide; in oxygen-enriched environments; or in any other potentially explosive environment may cause a fire and explosion hazard.



WARNING Do not use batteries from other sources. This may result in excessive temperatures, fire, or explosion.



WARNING To prevent fire or electrical shock, do not expose the device to rain or moisture.



WARNING Use only Welch Allyn approved accessories, and use them according to the manufacturer's instructions for use. Using unapproved accessories with the camera can affect patient and operator safety and can compromise product performance and accuracy, and void the product warranty.



WARNING Photosensitivity risk. While this device is considered low risk according to IEEE 1789, Practices for Modulating Current in High-Brightness LEDs for Mitigating Health Risks to Viewers, this device uses brief flashes of light to illuminate the patient eye for imaging. A very small percentage of individuals may experience epileptic seizures when exposed to certain light patterns or flashing lights. Apply clinical judgment when using this device.



WARNING Exposure to the RetinaVue 700 Imager flash, in rare cases, may contribute to migraines or temporary visual disturbances, particularly in patients with a history of light sensitivity or migraines. Multiple flashes per eye in a single exam may increase the likelihood of occurrence.



CAUTION Avoid subjecting the device to vibration or shock.



CAUTION Avoid using the device in a dusty environment.



CAUTION Keep the power cord away from any heat source.



CAUTION Do not sterilize the device.



CAUTION All servicing of this equipment is to be performed by Welch Allyn, Inc. or by a center approved by Welch Allyn, Inc.



CAUTION This device needs to be installed and put into service according to the EMC information provided herein.



CAUTION Portable and mobile RF communications equipment can affect the RetinaVue 700 Imager performance.



CAUTION Input overload can occur in proximity to defibrillator or electrocautery devices.



CAUTION This device is not protected against the ingress of water and should not be used in the presence of liquids which may enter the device.



CAUTION Data deleted on the device cannot be recovered.



CAUTION Do not modify this equipment without authorization of the manufacturer.



CAUTION Do not use the device in direct sunlight. Strong ambient light may affect results.



CAUTION Within the patient environment, only connect the equipment (the RetinaVue 700 Imager) to computers or laptops that have passed the safety standard for information technology equipment IEC 60601-1, EN 60601-1, ANSI/AAMI ES 60601-1 to ensure the safety of the USB electrical connection. Outside the patient environment, only connect the equipment (the RetinaVue 700 Imager) to computers or laptops that have passed the safety standard for information technology equipment IEC 60950-1, EN 60950-1, UL 60950-1 to ensure the safety of the USB electrical connection.



CAUTION Do not turn off the device while saving data from a patient test. Turning off the device while saving patient data may cause data loss.



CAUTION Do not use the device adjacent to or stacked with other equipment. If the device is used adjacent or stacked with other equipment, the device should be observed to verify normal operation in the configuration in which it will be used.



CAUTION Do not submerge the device in liquid or allow liquid to enter the interior of the device.



CAUTION Do not use automatic cleansing machines or sterilization.



CAUTION Consult the cleaning and disinfection agent manufacturer instructions for their proper use and germicidal efficacy, prior to their use.



CAUTION Consult your facility's procedures and the cleaning and disinfection agent manufacturer instructions for recommended Personal Protective Equipment and other safety precautions such as ventilation, etc..



NOTE The RetinaVue 700 Imager can be used on patients with eye implants and intraocular lenses. While the RetinaVue 700 Imager can be used on patients with cataracts and other eye opacities, images will likely be blurry or unreadable because of the refractive nature of the opacities.

Residual risk of magnets



WARNING Patient injury risk - magnetic fields. Exercise caution when using the RetinaVue 700 Imager in close proximity to implanted devices such as, but not limited to, cranial implants, adjustable CSF shunts, and pacemakers.

Design and protective measures have been implemented to limit magnetic interference to be lower than the limit set by the Active Implantable Medical Devices standards. Nevertheless, in the event the device is placed in close proximity to these life supportive devices, patient harm associated with magnetic field hazards cannot be completely excluded.

Warnings related to RetinaVue 700 Imager applied parts components

Warnings related to the face cup



WARNING Clean and disinfect the face cup after each patient to avoid the risk of cross-contamination.



WARNING Patient injury risk. The face cup of the RetinaVue 700 Imager uses magnets to attach to the device. If your patient has any type of cranial implant, it is advisable to reduce direct contact of the face cup's magnets with the patient's skin surface containing the implant.

Warnings and cautions related to accessories

Cautions related to the pedestal



CAUTION To avoid camera damage, remove camera from pedestal prior to transport.



CAUTION To avoid camera damage, position the pedestal on a stable surface to reduce the likelihood of shock, bump, or vibration hazards.

Warnings and cautions related to the Anterior Imaging Spacer



WARNING Patient injury risk. The Anterior Imaging Spacer of the RetinaVue 700 Imager uses magnets to attach to the device and to the face cup. If your patient has any type of cranial implant, it is advisable to reduce direct contact of the Anterior Imaging Spacer or the face cup's magnets with the patient's skin surface containing the implant.



CAUTION Failure to remove the Anterior Imaging Spacer before a Retina exam may result in unacceptable image quality or failure to capture an image.



CAUTION Failure to install the Anterior Imaging Spacer before an Anterior image exam may result in unacceptable image quality or failure to capture an image.

Warnings, cautions, and notes related to the battery charger



WARNING Electric shock hazard. Do not open the battery charger or attempt repairs. The battery charger has no user-serviceable internal parts. Inspection and servicing of internal parts shall only be performed by qualified service personnel.



WARNING Electric shock hazard. Before cleaning the battery charger, disconnect the AC power cord from the mains outlet and the power source.



WARNING Do not use batteries from other sources. This may result in excessive temperatures, fire, or explosion.



CAUTION Do not modify this equipment without authorization of the manufacturer.



CAUTION Use appropriate power plug for your country.



NOTE The removal of the plug from the socket provides the means of isolation from the mains power supply. The user is reminded to keep this means of disconnection easily accessible in case of emergency.

Caution related to the EMR test server



CAUTION Incorrectly setting up the RetinaVue 700 Imager to connect to a Wi-Fi test server may result in loss of exam data. The test server is NOT intended to be used for patient exams and is only intended for use by a software integrator on an EMR integration team. A patient's exam data cannot be recovered once sent to the Wi-Fi test server.

Controls and connectors

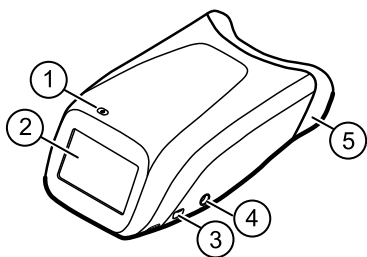

No.	Feature	Description
1	Power button	<ul style="list-style-type: none"> • Push button to turn the device on and off. • Push button to bring the device out of Sleep mode. • Push button to launch a dialogue box with three options: <ul style="list-style-type: none"> ○ Power down ○ Sleep ○ Cancel
2	LCD touchscreen	4.3 inch diagonal color LCD touchscreen.
3	USB port	Data transfer port
4	Charging port and power indicator	Connect AC power supply <ul style="list-style-type: none"> • When the LED light is green, it indicates that the device is fully powered. • When the LED light is orange, it indicates that the device is in the process of charging. • When the device is not charging the LED is off.
5	Face cup	Helps align the patient's eyes to the camera and blocks ambient light during testing

Bottom

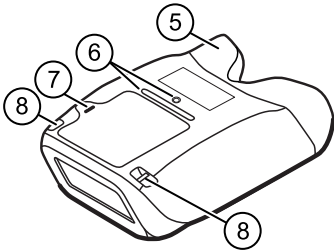

No.	Feature	Description
5	Face cup	Helps align the patient's eyes to the camera and blocks ambient light during testing
6	Pedestal mounting	Pedestal mounting well (1/4-20 thread) and locator ridge
7	Battery cover	Covers the battery compartment  NOTE The two service ports under the battery cover are for factory use only and are not for customer use.
8	Wrist or neck strap bracket	Wrist or neck strap mounting bracket

First time set up of the RetinaVue 700 Imager

Refer to the following topics when setting up the RetinaVue 700 Imager for the first time.

View images saved to the RetinaVue 700 Imager on the LCD touchscreen. The images saved on the RetinaVue 700 Imager are encrypted. To view the images on the computer, install the RetinaVue Network software application version 3.7 or later. For information on the RetinaVue Network software visit www.RetinaVue.com.

Unpack the system

The RetinaVue 700 Imager device is packaged with the following items. Confirm that all items are included.

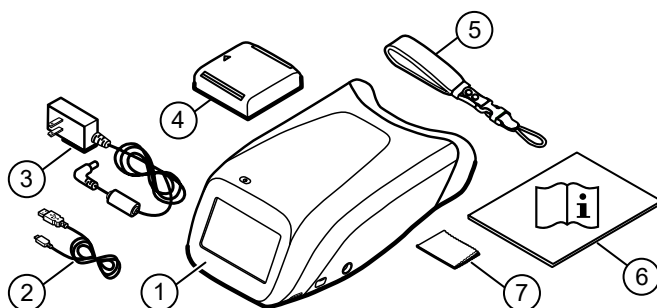

Number	Item	Description
1	RetinaVue 700 Imager device	Digital hand-held eye-fundus camera used to record digital photographs of the fundus of the human eye and anterior and

Number	Item	Description
		posterior ocular structures such as the cornea, lens and fundus including retina, macula and optic disc.
2	USB cable	Connects the device to a computer or laptop to transfer data.
3	Wall adapter plug and AC power cord	Connects the device to the wall adapter plug for AC charging. Match to region-specific AC wall outlet.
4	Lithium-ion battery	Battery
5	Wrist strap	Attaches to the device and slips over the wrist to hold the device.
6	RetinaVue 700 Imager <i>Instructions for use</i>	This document. The <i>Instructions for use</i> (IFU) is also available on the Welch Allyn web site.
7	Lens cloth	RetinaVue 700 Imager lens cloth

If any item is missing, contact Hillrom Technical Support: hillrom.com/en-us/about-us/locations/. We recommend that you save the shipping box and packing materials in case you need to store or ship the system.

Install the wrist strap



NOTE The strap can be mounted on the right or left side of the RetinaVue 700 Imager. Follow the manufacturer's instructions on wrist strap packaging.

1. Turn the RetinaVue 700 Imager over to access the wrist strap mounting bracket and set the RetinaVue 700 Imager on a flat, clean surface.

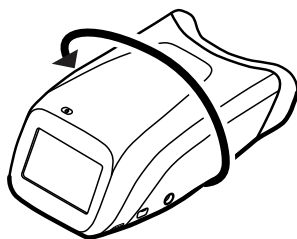

2. Detach the Uni-Loop system connector from the neoprene strap at the quick disconnect. Slide the ¼-inch webbing through the wrist strap mounting bracket and create an opening large enough to loop the Uni-Loop system connector through. Pull the Uni-Loop system connector tight to form a secure hold onto the RetinaVue 700 Imager. Pull the neoprene strap all the way through to secure the strap to the mounting

bracket. Click the Uni-Loop system connector to the neoprene strap to finish assembly. Slip the strap over your wrist and tighten the security slide to keep the strap firmly in place.

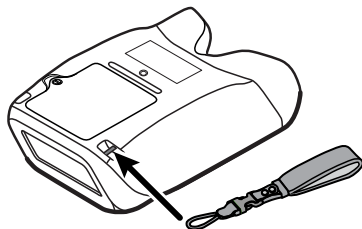

Battery installation and replacement

Use the device on battery power once the battery is installed and charged.



NOTE To charge the battery, plug the AC power cable into the device and the AC power supply.

Install the battery/replace the battery

Turn the RetinaVue 700 Imager over to access the battery cover and set the RetinaVue 700 Imager on a flat, clean surface.

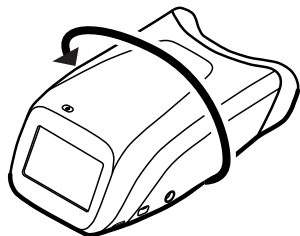

WARNING Improper disposal of batteries may create an explosion or contamination hazard. Never dispose of batteries in refuse containers. Always recycle batteries according to local regulations.



WARNING Risk of fire, explosion, and burns. Do not short-circuit, crush, incinerate, or disassemble the battery.



WARNING Use only Welch Allyn approved accessories, and use them according to the manufacturer's instructions for use. Using unapproved accessories with the camera can affect patient and operator safety and can compromise product performance and accuracy, and void the product warranty.

16 First time set up of the RetinaVue 700 Imager

1. Use a coin to loosen the screw at the edge of the battery cover.
2. Slide open the battery cover by tilting the cover upward.

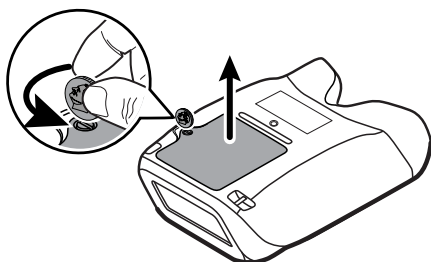

3. For first-time setup of the RetinaVue 700 Imager, insert the battery into the battery compartment.

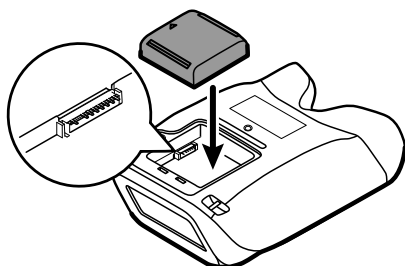

For battery replacement, remove the existing battery and then insert the new replacement battery into the battery compartment.

4. Insert the two battery cover tabs into the slots, then push in the tab to close the battery cover.
5. Tighten the screw at the edge of the battery cover.

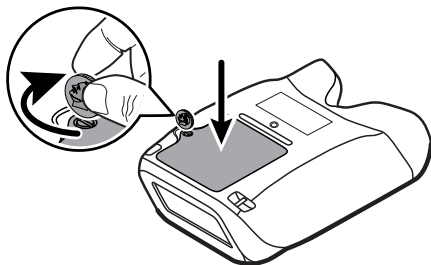

NOTE Do not over-tighten the screw.

Connect the power supply to the RetinaVue 700 Imager

1. Locate the power connector charging port on the RetinaVue 700 Imager and plug the power supply connector plug into the RetinaVue 700 Imager.

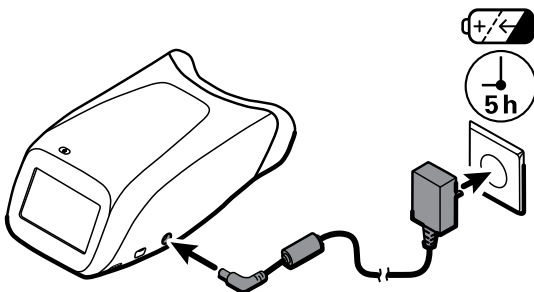

WARNING Use only Welch Allyn approved accessories, and use them according to the manufacturer's instructions for use. Using unapproved accessories with the camera can affect patient and operator safety and can compromise product performance and accuracy, and void the product warranty.



CAUTION The power supply connector easily inserts into the RetinaVue 700 Imager. Using force to connect the power supply connector plug can damage the device and will void the warranty.

2. Plug the power cord into an available wall outlet to charge the device. When the power indicator LED light is orange, it indicates that the device is in the process of charging.



NOTE For first time use, the device needs to be charged for 5 hours before use.



NOTE The removal of the plug from the socket provides the means of isolation from the mains power supply. The user is reminded to keep this means of disconnection easily accessible in case of emergency.

Startup

Power

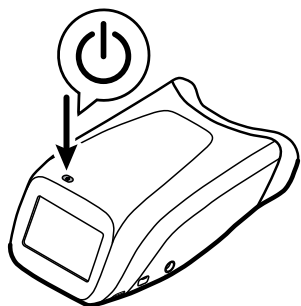

The Power button, located on the upper-left corner of the RetinaVue 700 Imager, performs multiple functions:

- powers up the RetinaVue 700 Imager
- wakes the RetinaVue 700 Imager from Sleep mode
- opens a dialogue screen with controls to power down, enter Sleep mode, or to cancel and return to the prior screen, depending on the option you choose

Power up the RetinaVue 700 Imager

The RetinaVue 700 Imager runs a brief diagnostic self-test each time it powers up.



CAUTION Always use the RetinaVue 700 Imager with an adequately charged and properly functioning battery.

1. Press  to power up the RetinaVue 700 Imager.

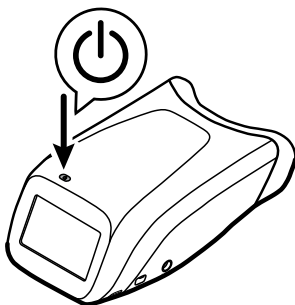

As the device is powering up, the RetinaVue 700 Imager displays the startup screen.

2. If this is the first time set up, select your preferred language from the drop-down list and then touch **Next**.

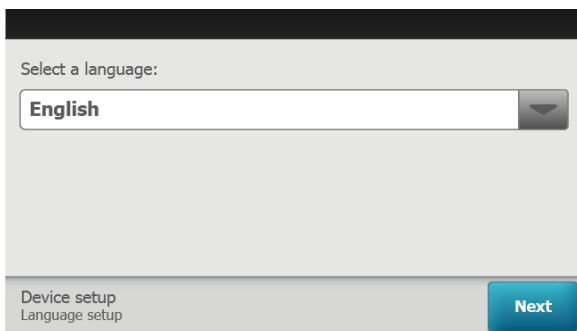

Select a language:

English

Device setup
Language setup

Next

3. Touch ▲ (up) or ▼ (down) to enter, or adjust, the Day, Month, and Year.
4. Touch ▲ (up) or ▼ (down) to enter, or adjust, the Hour, Minute (Min), Continent, and Location. Touch **Next**.

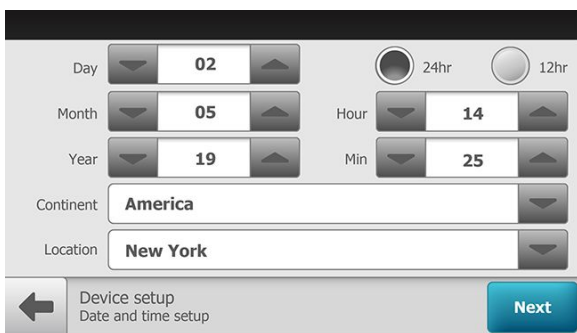

Day ▼ 02 ▲

Month ▼ 05 ▲

Year ▼ 19 ▲

Continent ▼ America ▼

Location ▼ New York ▼

Hour ▼ 14 ▲

Min ▼ 25 ▲

24hr 12hr

Device setup
Date and time setup

Next



NOTE Use the radio buttons to select the 24-hour or 12-hour format.

5. If you want to use the camera in practice mode before registering the camera, touch **Yes - I want to practice** and then touch **Next**.
 - a. If you want to proceed to registering the camera, touch **No - take me to registration** and then touch **Next**.

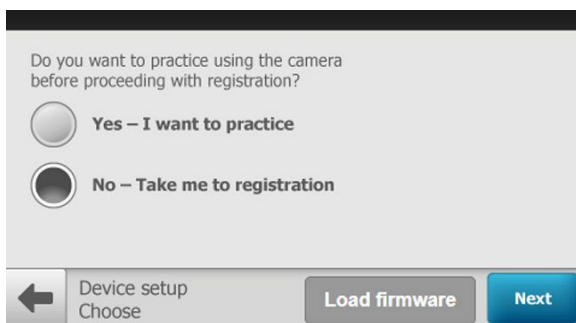

NOTE In rare instances, the device may not contain the latest firmware. Normally this process is completed through the menus: *Settings > Advanced settings > Firmware update*. Touch **Load firmware** to update the device firmware before registering the device. See the topic: *Update the RetinaVue 700 Imager firmware*.

Update the RetinaVue 700 Imager firmware

Before you begin, you will need the following:

- A computer with an Internet connection.
- A USB cable to connect the RetinaVue 700 Imager to a computer.
- The RetinaVue 700 Imager.
- Download the firmware update from https://www.retinavue.net/RN_CustomerPortal/ and transfer the firmware update to a computer.

1. If the device is not already powered on, press  to power up the RetinaVue 700 Imager.

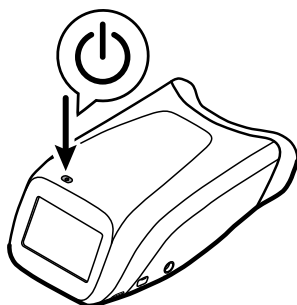

2. If this is the first time set up, select your preferred language from the drop-down list and then touch **Next**.

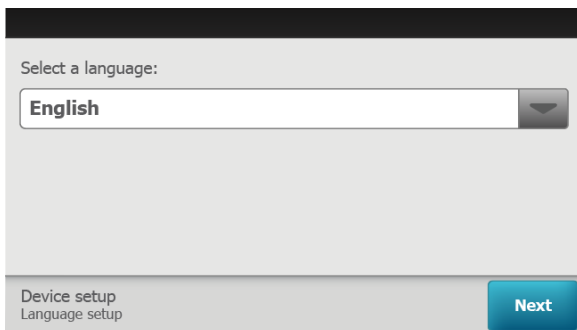

Select a language:

English

Device setup
Language setup

Next

3. Touch ▲ (up) or ▼ (down) to enter, or adjust, the Day, Month, and Year.
4. Touch ▲ (up) or ▼ (down) to enter, or adjust, the Hour, Minute (Min), Continent, and Location. Touch **Next**.



Day ▼ 02 ▲

Month ▼ 05 ▲

Year ▼ 19 ▲

Continent ▼ America ▼

Location ▼ New York ▼

Hour ▼ 14 ▲

Min ▼ 25 ▲

24hr 12hr

Device setup
Date and time setup

Next



NOTE Use the radio buttons to select the 24-hour or 12-hour format.

5. If you want to use the camera in practice mode before registering the camera, touch **Yes - I want to practice** and then touch **Next**.
 - a. If you want to proceed to registering the camera, touch **No - take me to registration** and then touch **Next**.

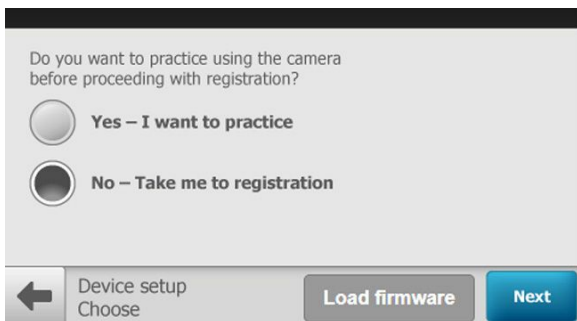

- b. If you want to proceed with loading the firmware, touch **Load firmware**.
- c. Touch **OK** at the prompt: "Are you sure you want to load new firmware now? Use a USB cable to connect the camera to the computer to transfer the new firmware to the camera."
- d. Touch **Load firmware** at the *Advanced settings > Firmware update* screen.
- e. Touch **OK** at the prompt: "Use a USB cable to connect the camera to the computer to transfer the new firmware to the camera."
- f. Plug the USB cable into the computer and the RetinaVue 700 Imager.

The screen prompt appears: "Camera plugged into computer. When finished loading file, unplug camera from the computer."

- g. Keep the RetinaVue 700 Imager plugged into the computer and transfer the firmware update from the computer to the RetinaVue 700 Imager by copying or dragging the file from the computer location into the RetinaVue 700 Imager device drive.



NOTE (In this example, "DATA (E:)"

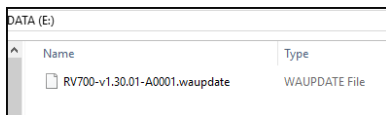



NOTE Use a safe eject method when ejecting the RetinaVue 700 Imager to ensure a complete software transfer to the RetinaVue 700 Imager. (Options include right-clicking on the *Start Menu > Open File Explorer > right-click on DATA, click Eject*. Or, click on the *Taskbar > Show hidden icons > click Safely Remove Hardware and Eject Media > click Eject RetinaVue Imager*.) If an eject menu is not available with your system settings, wait until the files have completely copied before manually ejecting the RetinaVue 700 Imager.

- h. Remove the USB cable from the RetinaVue 700 Imager.
- i. Touch **OK** at the prompt: "Install firmware".



NOTE The update process typically takes a few minutes to cycle through the complete update. During the update process, it is normal to see a process

update icon  that appears while the RetinaVue 700 Imager update successfully completes.

- j. Touch **OK** at the prompt: "Firmware update successful. Touch OK to restart the device."
- k. After the RetinaVue 700 Imager boots up, select your preferred language from the drop-down list and then touch **Next**.

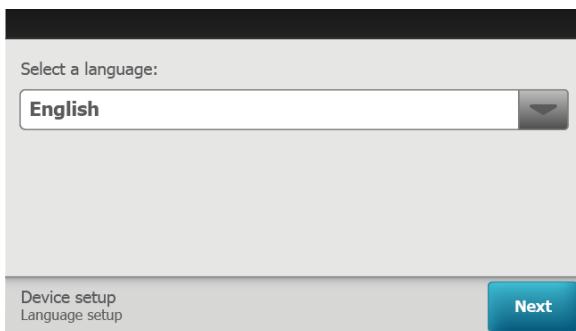

- i. Touch ▲ (up) or ▼ (down) to enter, or adjust, the Day, Month, and Year.
- m. Touch ▲ (up) or ▼ (down) to enter, or adjust, the Hour, Minute (Min), Continent, and Location. Touch **Next**.

Day ▼ 02 ▲ 24hr 12hr
Month ▼ 05 ▲ Hour ▼ 14 ▲
Year ▼ 19 ▲ Min ▼ 25 ▲
Continent America ▼
Location New York ▼
← Device setup
Date and time setup **Next**

- n. If you want to use the camera in practice mode before registering the camera, touch **Yes - I want to practice** and then touch **Next**.
- o. If you want to proceed to registering the camera, touch **No - take me to registration** and then touch **Next**.

Do you want to practice using the camera before proceeding with registration?
 Yes - I want to practice
 No - Take me to registration
← Device setup
Choose Load firmware **Next**

See the "USB camera registration" or the "Wi-Fi camera registration" topics for instructions to complete the camera registration.

First time selection of practice mode

Practice mode allows RetinaVue 700 Imager users to become familiar with the camera features and does not require camera registration. Screens in the Practice mode prominently display the text "Practice mode" and a blue banner also appears at the top of the screen. Most users prefer to run through Practice mode after registering the camera and just before performing their first exam. For further instruction about using Practice mode and returning to Practice mode after device registration, see the topic *Practice mode*.



CAUTION No data is preserved in Practice mode. Any data collected in Practice mode will be deleted when Practice mode is exited and cannot be recovered.

If you want to use the camera in practice mode before registering the camera, touch **Yes - I want to practice** and touch **Next**.

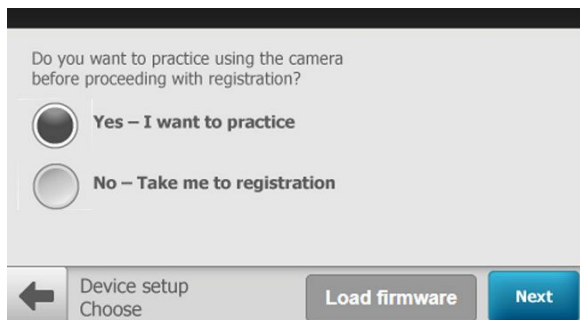

The *Practice mode* screen appears.

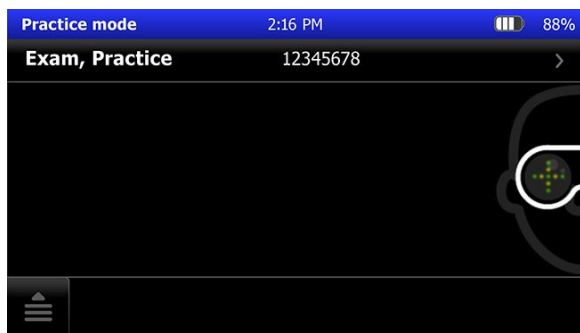

For instructions about using Practice mode see the topic *Practice mode*.

Exiting Practice mode

1. Touch  and then touch **Exit**.
2. Touch **OK** at the prompt: "Exit practice mode and return to camera registration?" to leave *Practice mode* and to complete the camera registration.

Camera registration

The RetinaVue 700 Imager needs to be registered and your clinic needs to have an account set up with RetinaVue Network to send exams for overread. There are two types of camera registration. Depending on your needs, select the USB registration or the Wi-Fi registration:

- Select the USB registration to use the RetinaVue 700 Imager with a USB cable and a computer connected to the Internet. The RetinaVue Network software application version 3.7 or later must be installed onto the computer to register the camera and to send exams to the RetinaVue Network.



NOTE The RetinaVue 700 Imager is not compatible with earlier versions of the RetinaVue Network software application.

- Select Wi-Fi registration and follow the instructions in the *Wi-Fi camera registration* topic to set up your RetinaVue 700 Imager to be used with your Wi-Fi network and the RetinaVue Network.
 - (Optional) If your organization requires Static IP, ensure your network IP information is available for manual entry. Follow the instructions in the section *Advanced camera registration* under the topic *Static IP Wi-Fi camera registration* to set up your RetinaVue 700 Imager to be used with a Static IP address on your Wi-Fi network and the RetinaVue Network.

USB camera registration

1. Touch **RetinaVue Network - USB** to select the USB workflow and touch **Next**.



NOTE Touch **Export log** to export logs into a viewable zip file. Touch **OK** at the prompt: "The log files are available for export. Use a USB cable to connect the camera to the computer to export files. When finished copying the file, unplug camera from the computer." After the RetinaVue 700 Imager is connected to a computer by the USB cable, navigate to the drive ["DATA (E:)" in the sample screen] and copy the compressed zip file to a location on the computer where the files can be viewed in a text file.

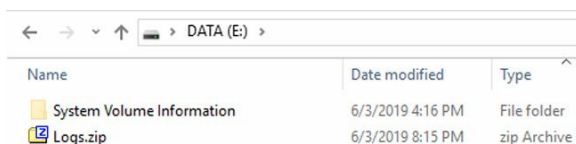

2. Touch **OK** at the *Setup completed* screen and follow the touchscreen instructions to connect the camera to a computer.



NOTE For the USB workflow, connect the RetinaVue 700 Imager camera via USB cable to a computer running the RetinaVue Network Client Version 3.7 or later.



NOTE If needed, the USB camera registration settings

can be reset after the initial set up. Touch  **>** **Settings > Advanced settings > Reset factory defaults.** Touch **Restore Settings.** Touch **OK** at the dialog: "Reset all settings to defaults? Any saved exams on this camera will be deleted."

Wi-Fi camera registration



NOTE The Wi-Fi camera registration only needs to be completed at the initial set up. See the *Reset factory defaults* instructions at the end of this section if a change to the camera registration is needed.

1. Touch **RetinaVue Network - Wi-Fi** to select the wireless workflow and touch **Next**.



2. Wait for the list of available networks to appear and then touch the Wi-Fi connection that you want to connect to.

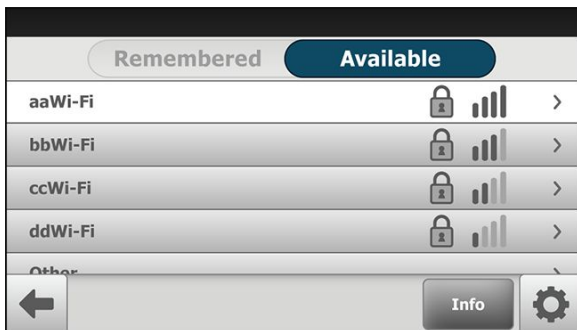

NOTE The list of remembered networks will not be enabled until you tell the device to remember at least one network. See step 3 for more information.



NOTE Wi-Fi network names shown here are examples. Do not select *Other* unless you cannot connect to a network in your environment.



NOTE If you don't see the desired Wi-Fi network that you want to connect to, you may need to scroll down.

3. Using a secured network, enter your network Passphrase.



NOTE Touch within the Passphrase field to launch the onscreen keyboard.

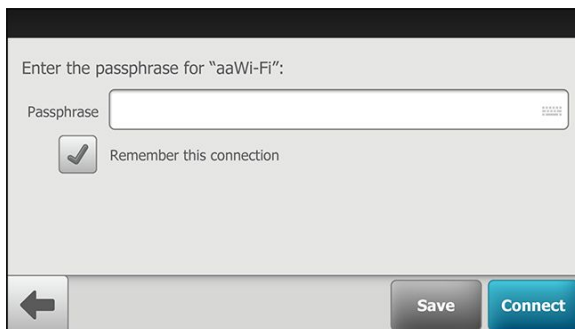

NOTE The checkbox next to "Remember this connection" is automatically selected, allowing you to use the selected network for subsequent Wi-Fi connections. If you do not want the camera to remember the connection, you may touch the checkbox to remove the check mark.



NOTE If you want the device to forget a remembered wireless network, see *Adjust the wireless network settings* in the *Controls* section of this document.

4. Touch **Connect**.
5. To continue setup, launch an Internet browser from a computer and enter the following address: https://www.retinavue.net/RN_CustomerPortal/.
6. On your RetinaVue 700 Imager, touch **Next**.
7. On the RetinaVue Network Customer Portal, enter your RetinaVue Network Username and Password then click **Log In**.

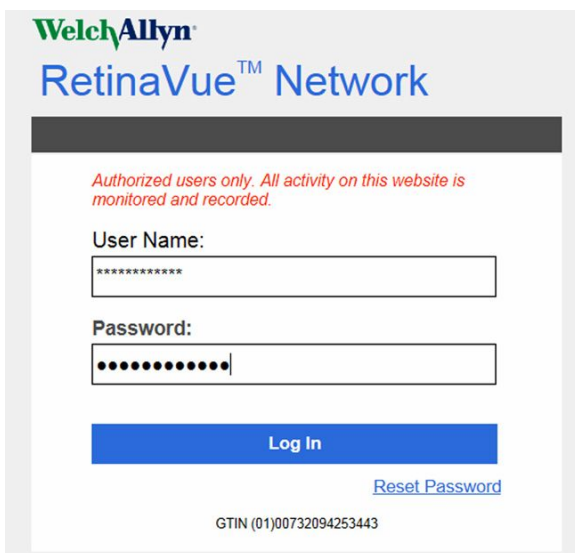

NOTE If prompted, click **I agree** to accept the End User License Agreement on the RetinaVue Network Customer Portal.

- On the RetinaVue Network Customer Portal, select *Manage Devices* and click **Next**.

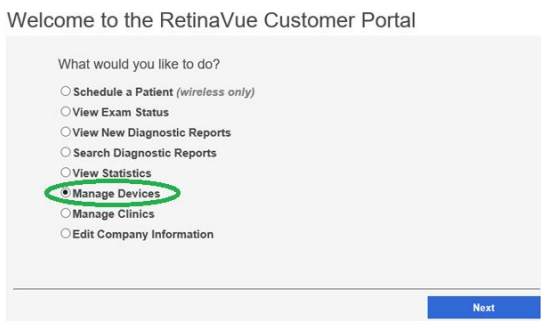

- Click **Add Device**.

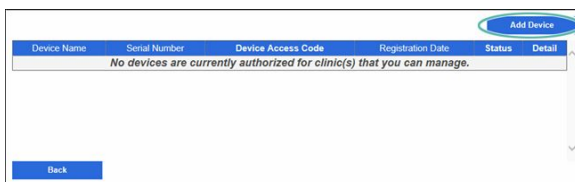

32 Camera registration

10. On your RetinaVue 700 Imager, touch **Next** to generate a Device Registration Code.
11. On the RetinaVue Network Customer Portal, enter the Device Registration Code from the RetinaVue 700 Imager and then click **Enter**.

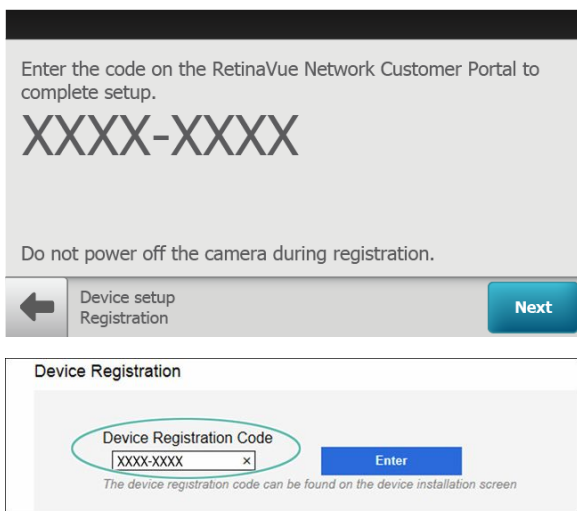

NOTE *The Device Registration Code shown here is an example.



NOTE The **Next** button is greyed out until the Device Registration Code is received by the RetinaVue 700 Imager from the RetinaVue Network Customer Portal.



NOTE The Device Registration Code needs to be entered into the RetinaVue Network Customer Portal as it appears on the RetinaVue 700 Imager *device installation* screen including the dash (-).



NOTE The device registration code will expire after 30 minutes. If registration is not completed within 30 minutes, the wireless registration can be restarted to obtain a new code.

12. On the RetinaVue Network Customer Portal, enter a Device Name (optional) and select a clinic, or clinics, where the RetinaVue 700 Imager will be used. Select each clinic by clicking the check box next to the clinic name and then click **Add Device**.

Warning: This registration request will expire if the device is not added by 10/3/2017 10:05:31 AM -04:00

Add New Device

Device Name
 ✕

Device Serial Number

Device Access Code

Select clinics to associate with this camera

	Clinic Name	Address
<input checked="" type="checkbox"/>	Mountain View Clinic	1234 Red River Road, Canyon Top, UT
<input checked="" type="checkbox"/>	Valley View Clinic	12345 Riverbend Ave, Valley View, UT

- a. (Optional) EMR integrators may use the EMR Test functionality to test WiFi and EMR connections by sending images to a test server. **CAUTION** This mode is NOT intended to be used for patient exams and is only intended for use by a software integrator on an EMR integration team.
- b. (Optional) To select multiple clinics where the RetinaVue 700 Imager will be used at, select each clinic by clicking the check box next to the clinic name.
- c. (Optional) To enable a Device access code for the RetinaVue 700 Imager, select the **Device Access Code** checkbox and enter your code into the *Device Access Code* field. The RetinaVue 700 Imager and the RetinaVue Network Customer Portal support from 4 to 6-digits in the Device access code.



NOTE Setting the Device access code before first use provides additional security features in the RetinaVue 700 Imager to prevent unintended access to patient information by unauthorized individuals.

- 13. On your RetinaVue 700 Imager, touch **Next** on the screen: *Camera registered successfully.*

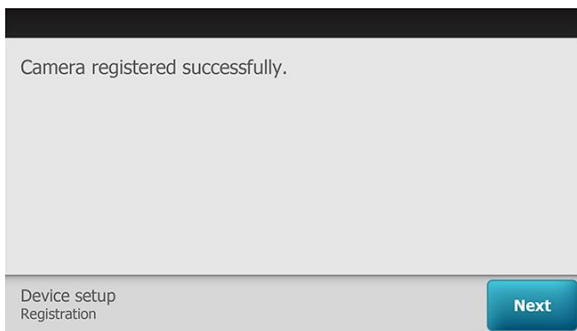

14. (Optional) If a Device access code was selected at the RetinaVue Network Customer Portal, touch **OK** at the prompt: *A new device access code has been downloaded. The camera will require this code on next encounter.*
15. (Optional) If multiple clinics were selected at the RetinaVue Network Customer Portal, use the drop-down menu to select the primary clinic where exams will be performed and then touch **Next**.
16. Touch **OK** at the *Setup complete* screen.
17. (Optional) If a Device access code was set at the RetinaVue Network Customer Portal, enter the Device access code on the RetinaVue 700 Imager and touch **OK**.



NOTE If needed, the Wi-Fi camera registration settings

can be reset after the initial set up. Touch  > **Settings > Advanced settings > Reset factory defaults**. Touch **Restore Settings** at the prompt: *"Do you want to restore to factory defaults? This will reset all device and radio settings. Any saved exams on this camera will be deleted."* Touch **OK** at the prompt: *"Reset all settings to defaults? Any saved exams on this camera will be deleted."*



NOTE If you are an administrator, you can also reset the Device access code from the camera. If you are not an administrator and would like to reset the code, please contact your administrator. The reset Device access code process will delete any saved exams and patient data. If you are an administrator, from the screen where you enter the Device access code, touch **Forgot code**. Next, touch **Factory reset**. A few prompts will appear, requesting you to confirm that you would like to continue with the factory reset. See the *Troubleshooting* topic for more information about resetting the Device access code.



NOTE If you want the device to forget a remembered wireless network, see *Adjust the wireless network settings* in the *Controls* section of this document.

Advanced camera registration

Static IP Wi-Fi camera registration



NOTE (Optional) If your organization requires Static IP, ensure your network IP information is available for manual entry.



NOTE Consult with your Network administrator to confirm your Static IP network IP information values before proceeding with these steps.

1. Touch **RetinaVue Network - Wi-Fi** to select the wireless workflow and touch **Next**.



2. To configure for a Static IP, touch  to navigate to the *Wi-Fi Radio settings* screen.

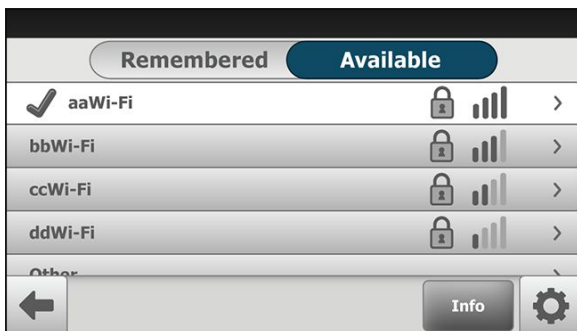

- For a Static IP, touch **Device IP** on the *Wi-Fi Radio settings* screen.



- Use the drop-down menu to select **Static IP** in the left pane of the *Wi-Fi Device IP* screen.

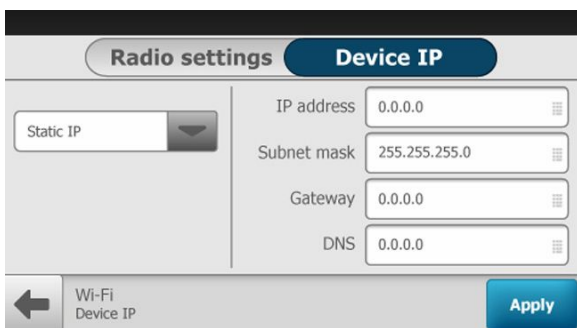

NOTE Static IP settings apply to all remembered networks. The device does not support setting individual static IP profiles for a single network.

- Touch within the *IP address*, *Subnet mask*, *Gateway*, or *DNS* fields in the right pane of the *Wi-Fi Device IP* screen to launch the onscreen numeric keypad.

6. Enter the IP address of the network you want to connect to and then touch **OK**.
7. Enter the Subnet mask of the network you want to connect to and then touch **OK**.
8. Enter the Gateway of the network you want to connect to and then touch **OK**.
9. Enter the DNS (IP address) of the network you want to connect to and then touch **OK**.
10. Once all the fields are filled in with the appropriate values, touch **Apply**.
 - Consult with your Network administrator if you do not know these values.
 - To cancel the Static IP Wi-Fi settings touch  (back) and then touch **OK** at the prompt: "Unsaved data will be discarded."
11. Using a secured network, enter your network Passphrase and touch **Connect**. **Note:** Touch within the Passphrase field to launch the onscreen keyboard.

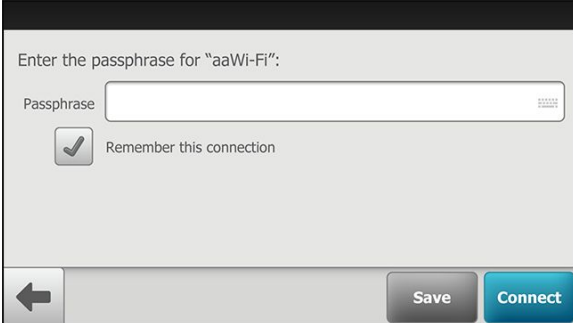

NOTE The checkbox next to "Remember this connection" is automatically selected, allowing you to use the selected network for subsequent Wi-Fi connections. If you do not want the camera to remember the connection, you may touch the checkbox to remove the check mark.

12. To continue setup, launch an Internet browser from a computer and enter the following address: https://www.retinavue.net/RN_CustomerPortal/.
13. On your RetinaVue 700 Imager, touch **Next**.
14. On the RetinaVue Network Customer Portal, enter your RetinaVue Network Username and Password then click **Log In**.

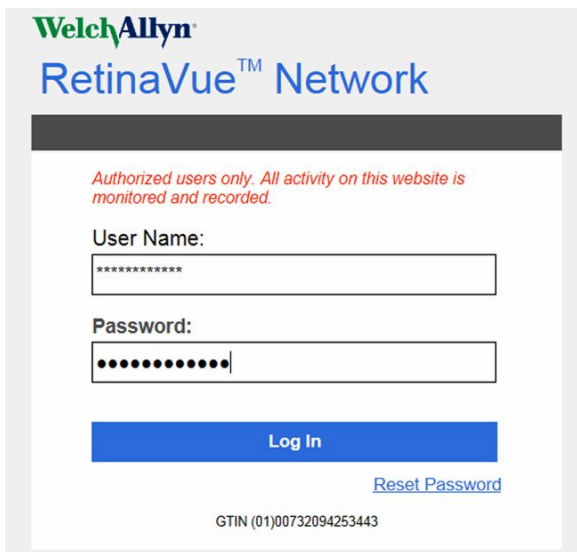

NOTE If prompted, click **I agree** to accept the End User License Agreement on the RetinaVue Network Customer Portal.

15. On the RetinaVue Network Customer Portal, select *Manage Devices* and click **Next**.

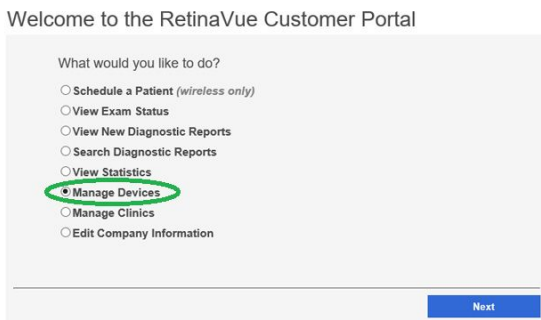

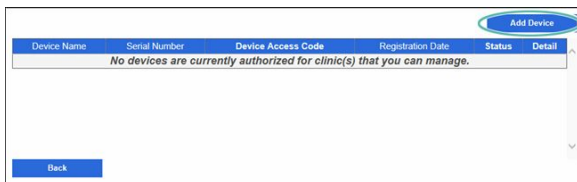

16. Click **Add Device**.



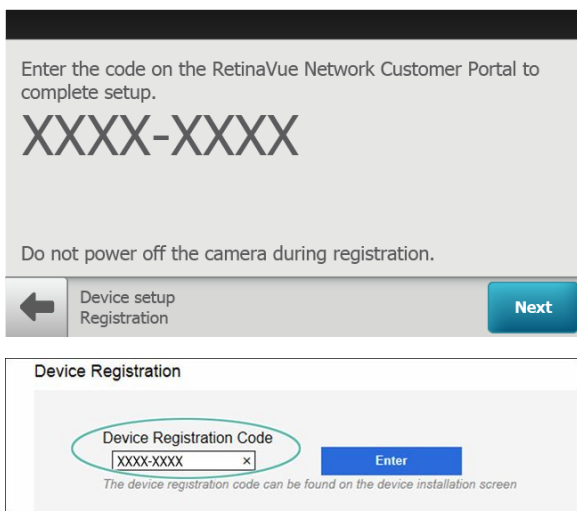

17. On your RetinaVue 700 Imager, touch **Next** to generate a Device Registration Code.
18. On the RetinaVue Network Customer Portal, enter the Device Registration Code from the RetinaVue 700 Imager and then click **Enter**.



 **NOTE** *The Device Registration Code shown here is an example.

 **NOTE** The *Next* button is greyed out until the Device Registration Code is received by the RetinaVue 700 Imager from the RetinaVue Network Customer Portal.

 **NOTE** The Device Registration Code needs to be entered into the RetinaVue Network Customer Portal as it appears on the RetinaVue 700 Imager *device installation* screen including the dash (-).

 **NOTE** The device registration code will expire after 30 minutes. If registration is not completed within 30 minutes, the wireless registration can be restarted to obtain a new code.

19. On the RetinaVue Network Customer Portal , enter a Device Name (optional) and select a clinic, or clinics, where the RetinaVue 700 Imager will be used. Select each clinic by clicking the check box next to the clinic name and then click **Add Device**.
 - a. (Optional) To select multiple clinics where the RetinaVue 700 Imager will be used at, select each clinic by clicking the check box next to the clinic name.

42 Advanced camera registration

- b. To enable a Device access code for the RetinaVue 700 Imager, select the **Device Access Code** checkbox and enter your code into the *Device Access Code* field. The RetinaVue 700 Imager and the RetinaVue Network Customer Portal support from 4 to 6-digits in the Device access code.



NOTE Setting the Device access code before first use provides additional security features in the RetinaVue 700 Imager to prevent unintended access to patient information by unauthorized individuals.

20. On your RetinaVue 700 Imager, touch **Next** on the screen: *Camera registered successfully.*

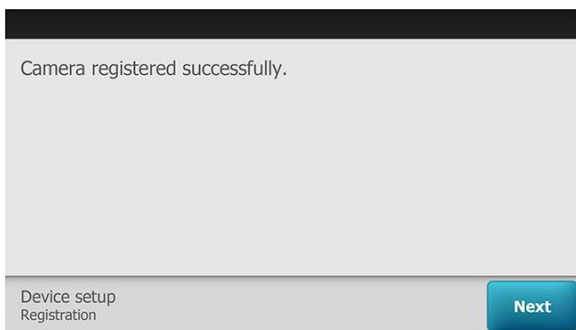

21. If a Device access code was selected at the RetinaVue Network Customer Portal, touch **OK** at the prompt: *A new device access code has been downloaded. The camera will require this code on next encounter.*
22. (Optional) If multiple clinics were selected at the RetinaVue Network Customer Portal, use the drop-down menu to select the primary clinic where exams will be performed and then touch **Next**.
23. Touch **OK** at the *Setup complete* screen.
24. If a Device access code was set at the RetinaVue Network Customer Portal, enter the Device access code on the RetinaVue 700 Imager and touch **OK**.



NOTE If needed, you can reset the Wi-Fi camera

registration settings after the initial set up. Touch  **> Settings > Advanced settings > Reset factory defaults.** Touch **Restore Settings** at the prompt: *"Do you want to restore to factory defaults? This will reset all device and radio settings. Any saved exams on this camera will be deleted."* Touch **OK** at the prompt: *"Reset all settings to defaults? Any saved exams on this camera will be deleted."*



NOTE If you are an administrator, you can also reset the Device access code from the camera. If you are not an administrator and would like to reset the code, please contact your administrator. The reset Device access code process will delete any saved exams and patient data. If you are an administrator, from the screen where you enter the Device access code, touch **Forgot code.** Next, touch **Factory reset.** A few prompts will appear, requesting you to confirm that you would like to continue with the factory reset. See the *Troubleshooting* topic for more information about resetting the Device access code.



NOTE If you want the device to forget a remembered wireless network, see *Adjust the wireless network settings* in the *Controls* section of this document.

FIPS Wi-Fi camera registration



NOTE During Wi-Fi communication, the RetinaVue 700 Imager supports the use of the following secure authentication types: WPA2-PSK and WPA2 Enterprise.



NOTE Consult with your Network administrator to confirm your network information before proceeding with these steps.

1. Touch **RetinaVue Network - Wi-Fi** to select the wireless workflow and touch **Next**.



2. To enable the FIPS mode, touch  to navigate to the *Wi-Fi Radio settings* screen.

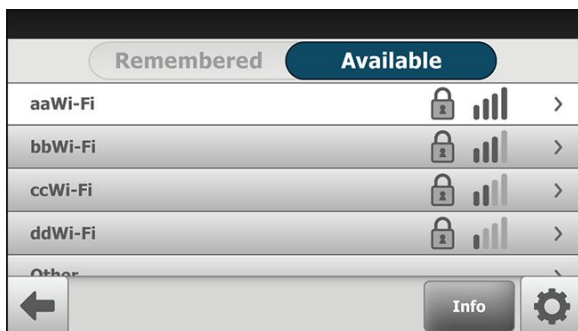

NOTE Wi-Fi network names shown here are examples. Do not select *Other* unless you cannot connect to a network in your environment.



NOTE If you don't see the desired Wi-Fi network that you want to connect to, you may need to scroll down.

3. If you are connecting to a FIPS environment, check the **Enable FIPS mode** box and touch **Update**. The RetinaVue 700 Imager may take several minutes to update.



4. See the standard "Wi-Fi camera registration" topic starting at step 3 for instructions to complete the camera registration.

Using the RetinaVue 700 Imager

The following topics describe the RetinaVue 700 Imager Tutorial and how to use the RetinaVue 700 Imager for performing exams, creating new patients, searching for patients, capturing additional images, deleting exams, and reviewing exams.

Additional information about image quality scores and exam protocols, the Auto exam mode, accessing exam protocols, and installing the face cup is also provided.

Auto exam mode

Auto Mode







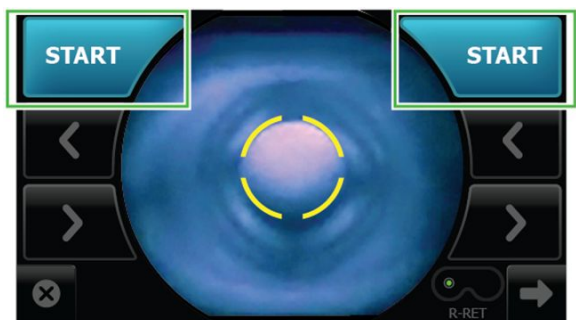

Auto Mode is the default image capture mode. Available features include:

- Exam protocol selection  (touch **Retina** or **Anterior**)
 - Sequential image capture order of the right and left eye
-



- Automatic image capture (touch **START**)
 - Navigation to the *Image Inspection* screen →
 - One touch exit ☒
-

About image quality scores

Good quality green (Inspection screen)	Good quality green (Exam summary screen)	If the image is of good quality, it is very likely to be read.
		(Scores of 40 +)
Acceptable quality yellow (Inspection screen)	Acceptable quality yellow (Exam summary screen)	If the image is of good enough quality, it is likely to be read.
		(Range of 20 — 39)
Unacceptable quality red (Inspection screen)	Unacceptable quality red (Exam summary screen)	If the image is lacking in quality, it is highly unlikely to be read.
		(Range of 0 — 19)

About the face cup

The face cup helps align both of the patient's eyes to the camera to allow them to best focus on the green lights in the camera lens. The face cup also blocks ambient light during a patient eye exam.

Install the face cup



WARNING Patient injury risk. The face cup of the RetinaVue 700 Imager uses magnets to attach to the device. If your patient has any type of cranial implant, it is advisable to reduce direct contact of the face cup's magnets with the patient's skin surface containing the implant.

Residual risk of magnets



WARNING Patient injury risk - magnetic fields. Exercise caution when using the RetinaVue 700 Imager in close proximity to implanted devices such as, but not limited to, cranial implants, adjustable CSF shunts, and pacemakers. Design and protective measures have been implemented to limit magnetic interference to be lower than the limit set by the Active Implantable Medical Devices standards. Nevertheless, in the event the device is placed in close proximity to these life supportive devices, patient harm associated with magnetic field hazards cannot be completely excluded.

If the face cup has not been previously installed, secure the face cup to the RetinaVue 700 Imager.

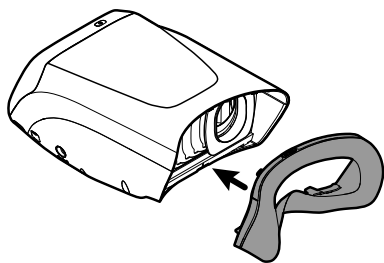

NOTE The face cup must be installed before capturing patient images.

About Exam protocols

Available Exam protocols include:

- Retina (RET)
- Anterior (ANT)

Retina (RET)

R-RET Captured images appear on the *Inspection* screen with a quality score and with a label **R-RET** (Right Retina- shown in the example).



L-RET Or, captured images appear on the *Inspection* screen with a quality score and with a label **L-RET** (Left Retina).



CAUTION Failure to remove the Anterior Imaging Spacer before a patient Retina exam may result in unacceptable image quality or failure to capture an image. The Anterior Imaging Spacer is an available accessory for the RetinaVue 700 Imager.

Anterior imaging Evaluate and document anterior ocular structures like lids, lashes, and cornea.

R-ANT Captured images appear on the *Inspection screen* with a label **R-ANT** (Right Anterior- shown in the example).

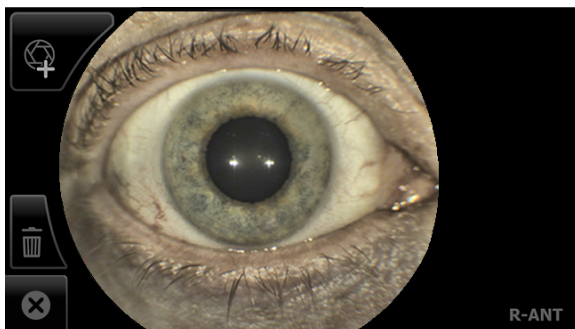

L-ANT Or, captured images appear on the *Inspection screen* with a label **L-ANT** (Left Anterior).



CAUTION Failure to install the Anterior Imaging Spacer before a patient Anterior exam may result in unacceptable image quality or failure to capture an image. The Anterior Imaging Spacer is an available accessory for the RetinaVue 700 Imager.

Accessing exam protocols

From the *Pre Acquisition* screen, touch  (**Settings**) to select the desired Exam protocol. Exam protocols are available in both manual and automatic mode.

Touch the desired Exam protocol button and touch **OK** at the prompt.



NOTE The currently selected Exam protocol appears shaded and becomes the default protocol for future exams on the RetinaVue 700 Imager until another protocol is selected.

Tutorial

The tutorial includes the following information:

- Start exam by touching **START EXAM** button on the screen
- Support camera by placing camera firmly on patient's face
- Align camera with eyes
- Ask the patient to look for the plus sign in the lens
- Align the pupil to the circle
- If necessary, use arrows to align the pupil to the circle
- Touch **START** and hold the camera steady
- Align the second pupil and if necessary, use arrows to align the pupil to the circle

Follow the instructions to create a new patient and to start an exam.

1. Once all the required fields are complete, touch **Exam** to proceed to the Tutorial.

Last name	Anderson	Middle initial	P
First name	John	Gender	Male
DOB	05/12/1962	Diabetes type	Type II
Patient ID	12345678		
Referring provider	Murphy, Ryan MD		

← Patient summary
Delete
Exam

2. Touch **Tutorial** to begin.



3. To stop the tutorial, touch the screen. To resume, touch **Continue tutorial**.
4. To proceed to an exam, touch the screen and then touch **START EXAM**.

Before starting an eye exam



NOTE The recommended network bandwidth is 1 Mbps in a low-latency environment. A network bandwidth of 0.5 Mbps or less may delay or prevent the transmission of images and results.

If the RetinaVue 700 Imager is not already on, press the power button.

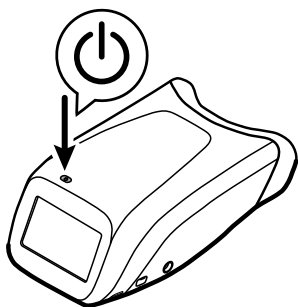

NOTE To conserve power, the RetinaVue 700 Imager enters Sleep mode if it remains idle for the time set during set up. (Sleep mode settings include 2, 5, 7, 10 minutes, and Never). Touch the LCD screen or press the power button to wake up the RetinaVue 700 Imager from Sleep mode.



NOTE Unless *Never* is selected, the RetinaVue 700 Imager powers down after 10 minutes of inactivity in Sleep mode. Press the power button to activate the RetinaVue 700 Imager. (See the *Settings* sections for information about changing the Sleep mode settings.)



NOTE The RetinaVue 700 Imager can be used on patients with eye implants and intraocular lenses. While the RetinaVue 700 Imager can be used on patients with cataracts and other eye opacities, images will likely be blurry or unreadable because of the refractive nature of the opacities.

Instructions for patients

- Have the patient sit in a dark room for 5 minutes to dilate their pupils. To ensure that the patient's pupils sufficiently dilate, adjust the room lighting to the lowest possible level.
- Ask your patient to remove their glasses, contacts can remain in place.

- If using the RetinaVue 700 Imager without the optional pedestal accessory, ask the patient to sit up straight in a chair, then stand directly in front of the patient.
- Tell the patient that their right eye will be imaged first and then their left eye will be imaged.
- Ask the patient to look forward and hold their head still.
- Ask the patient to keep both eyes open as wide as possible and limit blinking.
- Ask the patient to follow the green dot inside the camera.

Remove the Anterior Imaging Spacer for a patient Retina exam



NOTE The Anterior Imaging Spacer is an available accessory for the RetinaVue 700 Imager. Your imager may not have one.

1. When performing a Retina exam, remove the face cup and the Anterior Imaging Spacer from the RetinaVue 700 Imager

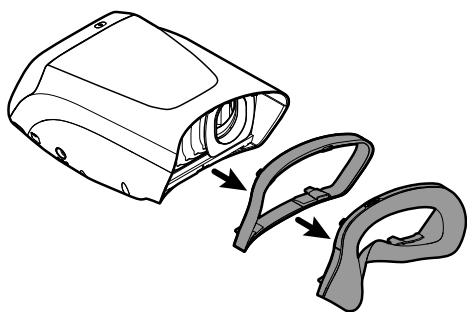

and then reattach just the face cup to the RetinaVue 700 Imager.

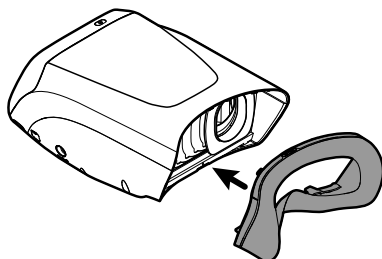



CAUTION Failure to remove the Anterior Imaging Spacer before a Retina exam may result in unacceptable image quality or failure to capture an image.

2. From the *Pre Acquisition* screen, touch  (**Settings**) to select the Retina Exam protocol.
3. Touch **Retina** and touch **OK**.



4. Touch **OK** at the prompt: *"Before continuing with selected exam: remove the Anterior Imaging Spacer between camera and face cup."*

Perform a retina eye exam



WARNING Clean and disinfect the face cup after each patient to avoid the risk of cross-contamination.

1. From the *Patients* screen, touch on the Patient's name or ID (MRN). Any scheduled patients appear on the *Patients* screen. (Wireless workflow images shown)



2. Touch **Exam** to open a new exam.

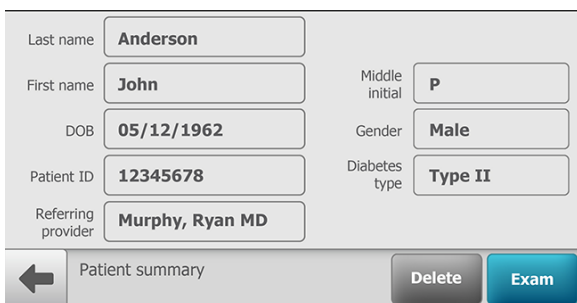

3. Touch **START EXAM**.



4. Position the RetinaVue 700 Imager about 4 inches directly in front of your patient. Keep the RetinaVue 700 Imager **level** and **in line** with your patient's eyes. Brace your arms against your body to help keep the RetinaVue 700 Imager steady.
5. Move the RetinaVue 700 Imager toward the patient and align the yellow circle to the patient's right pupil.

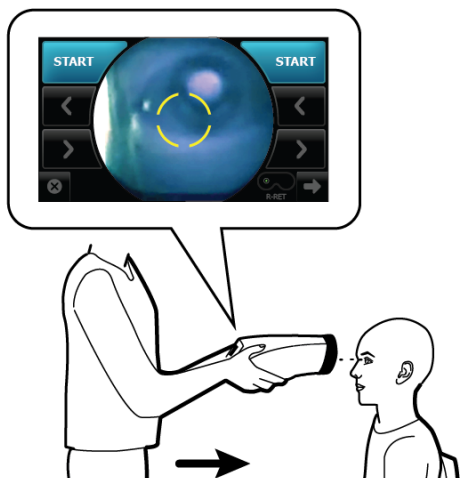

6. Place the face cup firmly on the patient's face. Do not hover near the face with the RetinaVue 700 Imager. Keep the RetinaVue 700 Imager level.

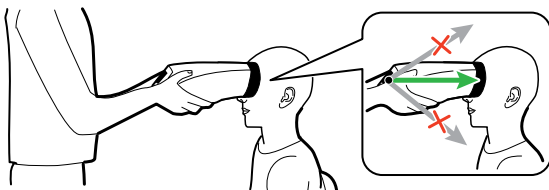

NOTE After placing the face cup firmly on the patient's face, the right pupil should be visible within the screen.

7. If the pupil is located above or below the yellow circle, as shown, slide the RetinaVue 700 Imager **slightly** up or down on the patient's face to align the yellow circle to the pupil.

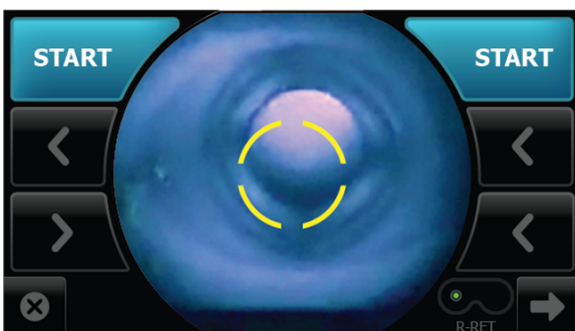

8. If needed, touch < or > to align the yellow circle to the pupil.

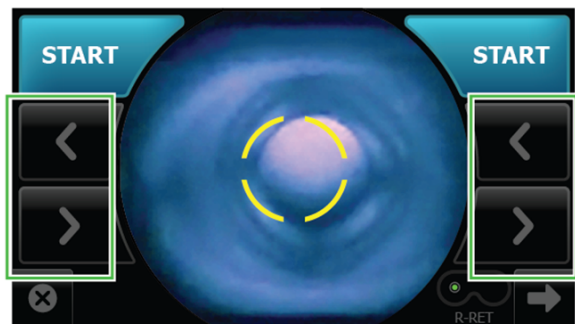

9. Ask the patient "Can you see the **entire** plus sign?". Inform the patient that the plus sign will transition into a green dot. Ask the patient to follow the green dot.

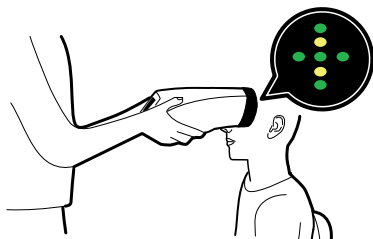

10. Press the face cup **firmly** against the patient's face and then touch **START**.

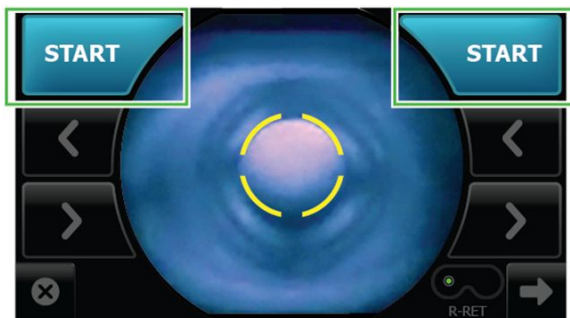

11. Hold steady until the image is captured.



If the audio volume is set to an audible level, a camera shutter tone alerts you once the right eye image has been captured.

A timer appears and counts down. This wait time allows the patient's eyes to recover from the flash.

After the timer ends, the RetinaVue 700 Imager automatically moves to the left eye, and the message: "Lens moving to the next eye" appears.







NOTE You can adjust the timer settings from the Advanced settings menu. See the topic *Adjust wait time between image captures* in the *Advanced features* topic for more information.

12. Repeat the steps to align the yellow circle to the pupil and capture an image of the left eye.

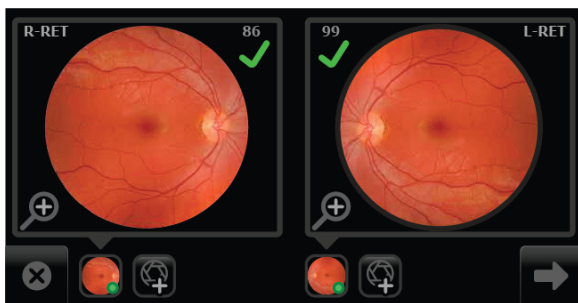
If the audio volume is set to an audible level, a camera shutter tone alerts you once the left eye image has been captured.

13. Once both images have been captured, view the acquired images on the *Post Acquisition* screen.





- If the image is of good quality (scores of 40 +) , it is very likely to be read.
 - If the image is of good enough quality (range of 20 — 39) , it is likely to be read.
 - If the image is lacking in quality (range of 0 — 19) , it is highly unlikely to be read.
 - the retina image for the right eye contains the **R-RET** label
 - the retina image for the left eye contains the **L-RET** label
14. From the *Post Acquisition* screen, touch  to view the displayed image for the right or left eye. The *Inspection mode* screen appears.



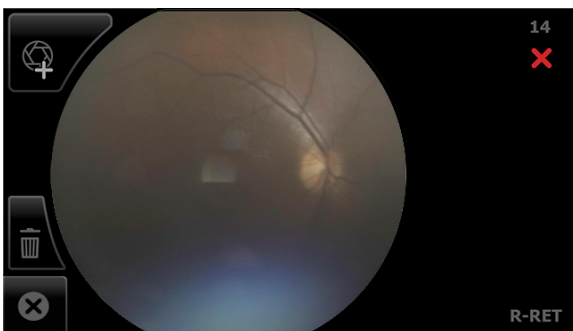

Images with a red X () and low score denote low quality images.

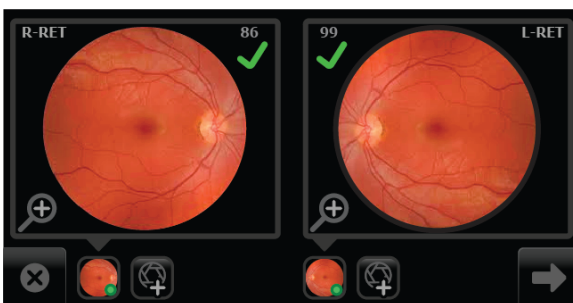

Touch  (delete) to dispose of an image and to begin a capture of another image. Touch **OK** at the prompt "Do you want to discard this image?". From the *Post Acquisition* screen, touch  (Add image) to capture an additional image using the existing protocol.

- From the *Post Acquisition* screen,



touch  (**Next**) after all images are captured.



NOTE If no images are captured the prompt message appears that: "You must capture at least one image before continuing." See the topic: *Capture additional images using the same protocol* for information about adding an image. If the image for one eye is captured and then you exit the exam the prompt message appears: "Discard unsaved images and patient data?", either touch **OK** to exit the exam without saving the image and patient data, or touch **Cancel** to resume the exam.

- From the *Exam summary* screen,

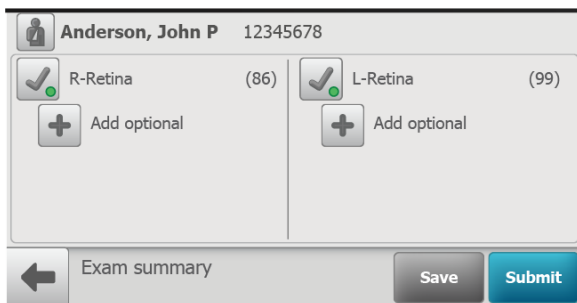

if the images contain a green or yellow quality acceptance check mark:

- a. Touch **Save** to save the exam to the device for further review or editing.
- b. Touch **Submit** to submit the exam to the RetinaVue Network Customer Portal.

Create a patient on the camera

- From the *Patients* screen, touch  if available, to create a new patient. (Wireless workflow images shown)

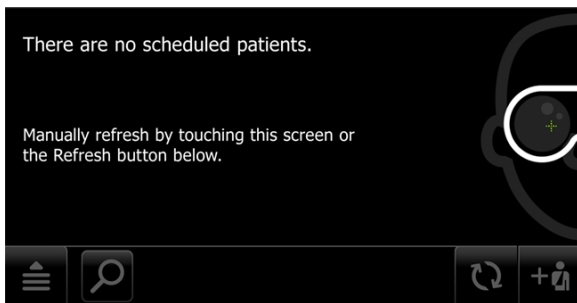



- Touch within the Patient's Last name, First name, or Middle initial entry box to launch the on-screen keyboard.

Last name*	<input type="text"/>	
First name*	<input type="text"/>	Middle initial <input type="text"/>
DOB*	<input type="text"/>	Gender* <input type="text"/>
Patient ID*	<input type="text"/>	Diabetes* type <input type="text"/>
Referring provider*	<input type="text"/>	

Patient summary

- Enter the patient's last name and first name and touch **OK**. (Middle initial is optional.)
- Enter the patient's DOB (Date of Birth) and touch **OK**. (Touch within the DOB field to launch the on-screen keyboard and to enter the patient's Date of Birth.)
- Enter the patient's gender by using the drop-down menu to select Male, Female, or (in the wireless workflow) Other.
- Enter the patient's ID and touch **OK**.
- Touch within the Referring provider field entry box to launch the on-screen keyboard and search for your clinic's Referring provider and touch **OK**. (Only required for the wireless workflow.)
- Enter the patient's Diabetes type using the drop-down menu to select Type I, Type II, or None. (Only required for the wireless workflow.)
- Once all the required fields are complete, touch **Exam** to open a new exam.

Last name	Anderson	Middle initial	P
First name	John	Gender	Male
DOB	05/12/1962	Diabetes type	Type II
Patient ID	12345678	Referring provider	Murphy, Ryan MD

 Patient summary
 



NOTE To edit patient data, touch within the desired field to launch the on-screen keyboard, touch the backspace key to delete information, retype the correction using the on-screen keyboard, and then touch **OK**.

Optionally, to save the patient information without starting an exam, touch **Save**. See *Perform a Retina eye exam* or *Perform an Anterior Image eye exam* for further instructions on performing an eye exam.

Search for a patient in the Scheduled patients list

- From the main *Patients screen*, touch  to search for a patient. (**Wireless workflow images shown**)

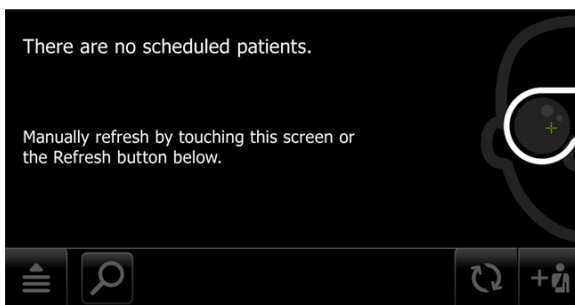

- Search for *Scheduled patients* downloaded to the RetinaVue 700 Imager from the RetinaVue Network Customer Portal (Wi-Fi) or from from the RetinaVue Network software application (USB).

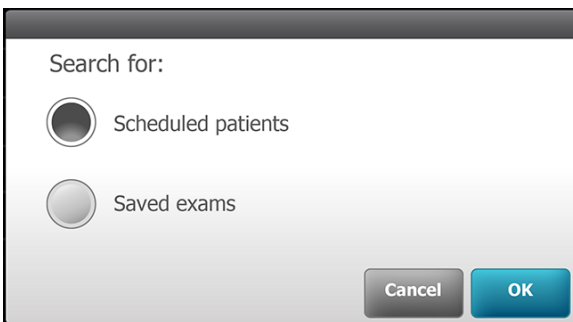

3. Touch **OK** to launch the on-screen keyboard.
4. Begin typing the patient's last name, first name, or Patient ID (MRN #) into the entry field box and then touch **OK** on the on-screen keyboard.

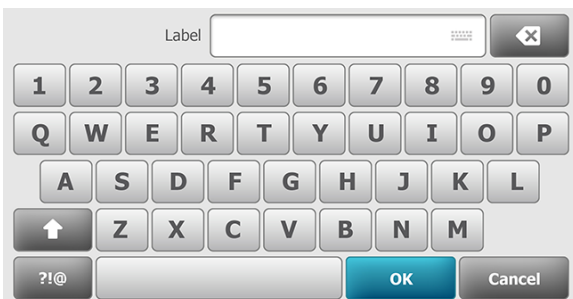

The list of patients appears on the *Patient list search* screen based on search parameters.

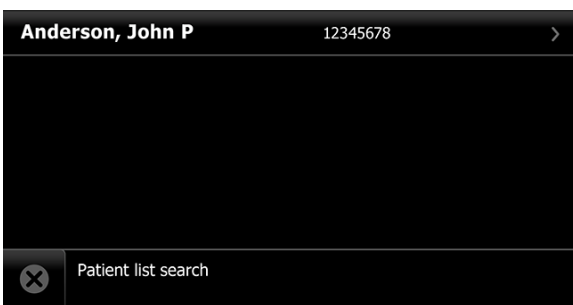

NOTE Patients created on the camera are also considered "scheduled" once the patient information is saved. Created patients appear in the *Patient list search*.

5. Touch on a patient's name or ID to select that patient. The *Patient summary* screen appears.

Last name	Anderson	Middle initial	P
First name	John	Gender	Male
DOB	05/12/1962	Diabetes type	Type II
Patient ID	12345678		
Referring provider	Murphy, Ryan MD		

← Patient summary Delete Exam



NOTE Patient information is not editable for patients created on the RetinaVue Network Customer Portal or from the RetinaVue Network software application (USB).

6. Refer to *Perform a Retina eye exam* or *Perform an Anterior Image eye exam* for instructions on performing exams and acquiring images.

Search for a patient in the Saved exams list

1. From the main *Patients screen*, touch  to search for a patient. (**Wireless workflow images shown**)

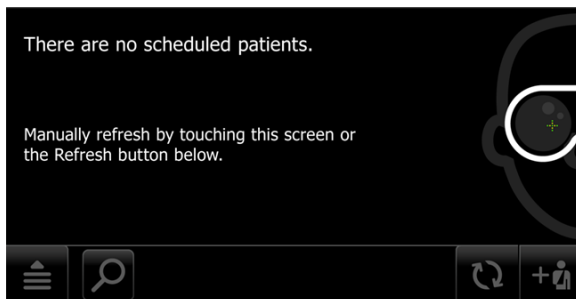

2. Touch **Saved exams** to search for patients in the *Saved exams* list of patients already contained on the camera and then touch **OK** to launch the on-screen keyboard.

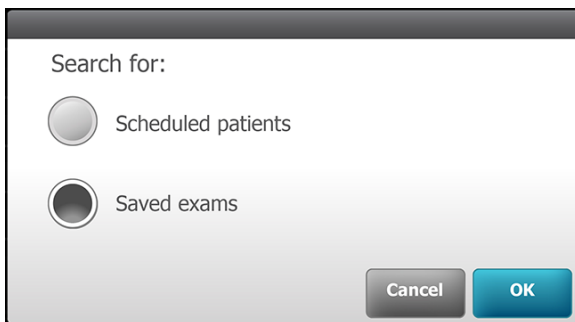

NOTE Patients in the *Saved Exams* list already have completed or partially completed exams.

3. Begin typing the patient's last name, first name, or Patient ID (MRN #) into the *Search* entry field and then touch **OK** on the on-screen keyboard.

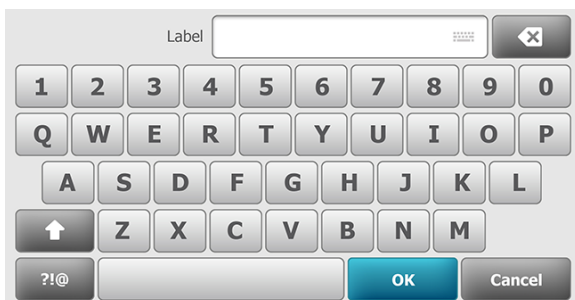

The *Saved/Submitted* list of patients appears on the *Review* screen based on search parameters.

Saved		Submitted	
Kinglongname, Katie M	9109830108	Jan 12 9:22 AM	>
Baumlonglastname, W	9109830108	Jan 12 9:54 AM	>
Stevens, Johnathan C	9109830108	Jan 12 11:43 AM	>
Wagner, Michael R	9109830108	Jan 13 4:36 PM	>
Somelongname, Thomas J	9109830108	Jan 14 2:19 PM	>

Review 

4. Touch on a patient's name or ID to select that patient. The *Exam summary* screen appears.

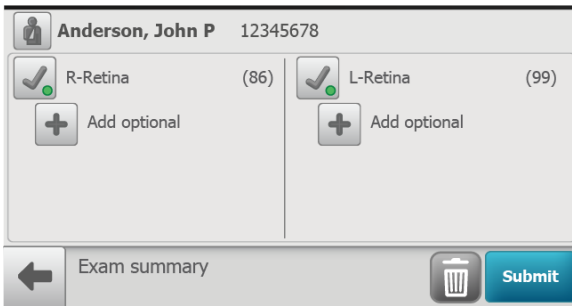

- 5. From the *Exam summary* screen, exams can be deleted or submitted.

Delete an image during an eye exam





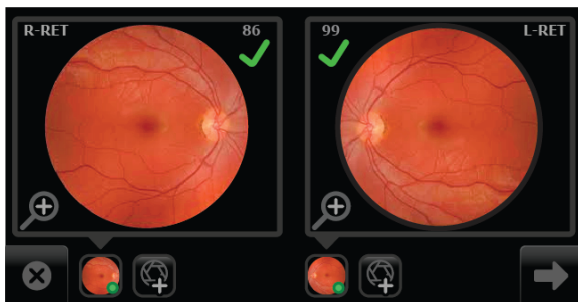

CAUTION Data deleted on the device cannot be recovered.

1. From the *Post Acquisition* screen,



touch  to review the current image on the *Inspection mode* screen. (Right eye *Image Inspection* screen shown).





- If the image is of good quality (scores of 40+) , it is very likely to be read.
- If the image is of good enough quality (range of 20 — 39) , it is likely to be read.
- If the image is lacking in quality (range of 0 — 19) , it is highly unlikely to be read. Images with a red X () and a low score

denote low quality images and should be deleted.

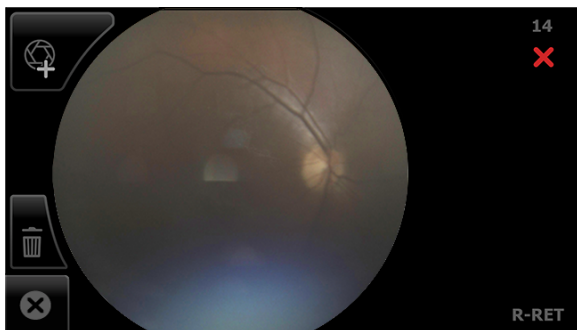
- From the *Image Inspection* screen, touch  (delete) to dispose of an image and return to the *Acquisition* screen to begin a capture of another image.



Touch **OK** at the dialog prompt: "Do you want to discard this image?". From the *Post Acquisition* screen, touch  (Add image) to capture an additional image using the existing protocol.

- Capture the remaining images and touch  (**Next**) to complete the exam.

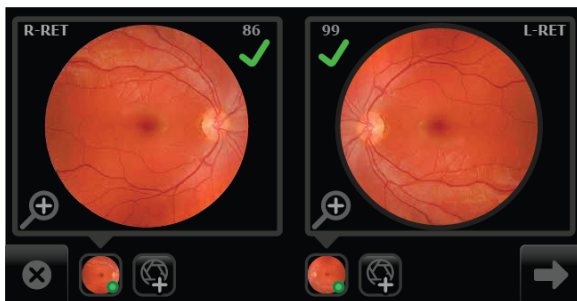

- When the image capture is complete and the images contain a green or yellow quality acceptance check mark, proceed to the *Exam summary screen* and touch **Save** or **Submit**.

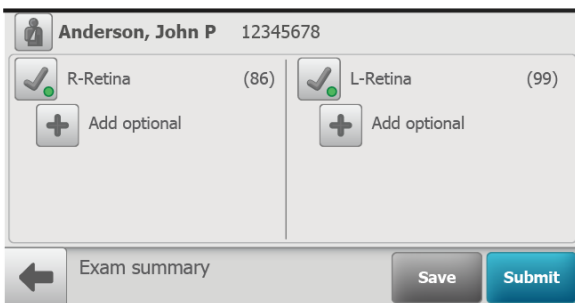

- Touch **Save** to save an exam to the device for further review or editing. The *Exam Saved* dialog appears.
- Touch **Submit** to submit the exam to the RetinaVue Network Customer Portal.



NOTE In the Wireless mode, the "Exam is queued up to be submitted." message appears.

Delete a patient



CAUTION Data deleted on the device cannot be recovered.

1. From the main *Patients screen*, touch on the patient's name or ID number.



2. Touch **Delete**.

Last name	Anderson	Middle initial	P
First name	John	Gender	Male
DOB	05/12/1962	Diabetes type	Type II
Patient ID	12345678		
Referring provider	Murphy, Ryan MD		

← Patient summary Delete Exam

Touch **OK** at the prompt: "Are you sure you want to delete the patient file?" This patient will also be deleted on the RetinaVue Network Customer Portal." (Wi-Fi), or "Are you sure you want to delete the patient file?" (Patient created on the camera).



NOTE See the Troubleshooting section if the following Wi-Fi error message appears: "Failure to connect to the portal. Unable to delete patient information".

Delete a patient and exam



CAUTION Data deleted on the device cannot be recovered.

1. From the main *Patients screen*, touch  to search for a patient. (Wireless workflow images shown)

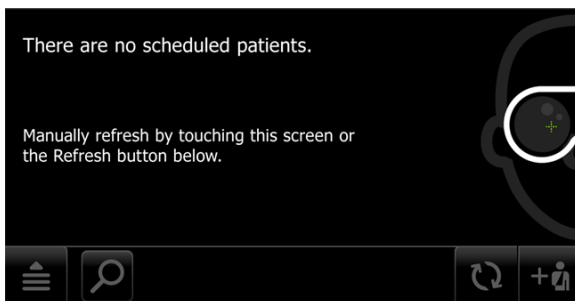

2. Search for patients in either the *Scheduled patients* or *Saved exams* list of patients already contained on the RetinaVue 700 Imager.

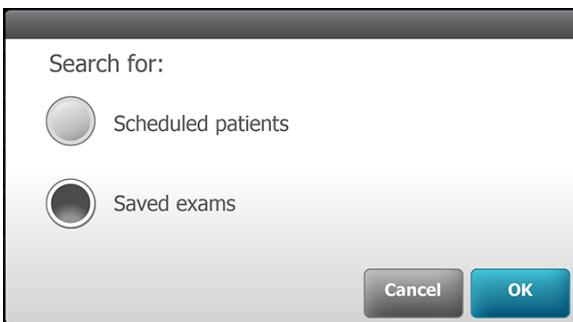

3. Touch **OK** to launch the on-screen keyboard and begin typing the patient's last name, first name, or Patient ID (MRN #) into the entry field box and then touch **OK** on the on-screen keyboard.

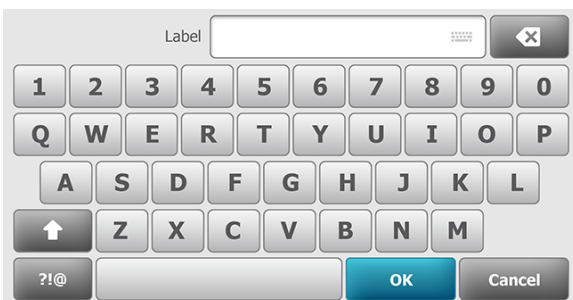

The *Saved/Submitted* list screen appears.

Saved		Submitted	
Kinglongname, Katie M	9109830108	Jan 12 9:22 AM	>
Baumlonglastname, W	9109830108	Jan 12 9:54 AM	>
Stevens, Johnathan C	9109830108	Jan 12 11:43 AM	>
Wagner, Michael R	9109830108	Jan 13 4:36 PM	>
Somelongname, Thomas J	9109830108	Jan 14 2:19 PM	>
	Review		

4. For **Saved exams**, touch on a patient's name or ID to select that patient. The *Exam summary* screen appears.
5. Touch  (delete) to remove the patient and the exam from the RetinaVue 700 Imager.

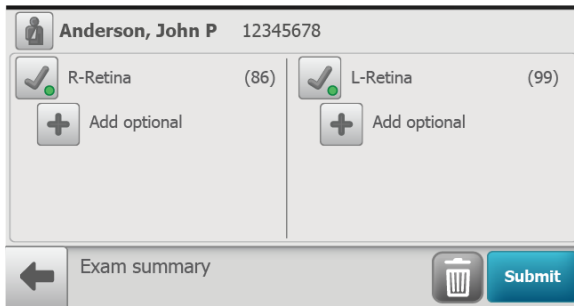

6. Touch **OK** at the screen prompt: "Are you sure you want to delete this patient's information and exam?"

Capture additional images using the same protocol

1. From the *Post Acquisition* screen, touch  (Add image) to capture an additional image using the existing protocol.

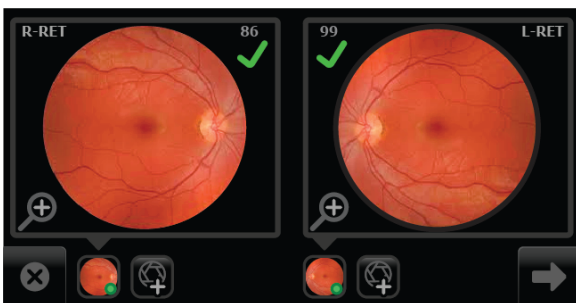

- If the image has a yellow or blue information message, observe the tips to capture another image to improve the image quality of the new image.
2. As the new images are captured by the RetinaVue 700 Imager , the new image icon appears in the place of the image capture icon. Touch  (Next) after all images are captured.
 3. When the image capture is complete and the images contain a green or yellow quality acceptance check mark, proceed to the *Exam summary* screen and touch **Save** or **Submit**. However, if there is a missing image on the *Exam summary* screen:

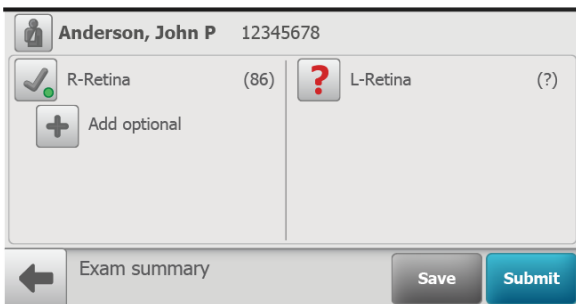

- Touch  (Missing image) to capture an image using the existing protocol. As the

new images are captured by the RetinaVue 700 Imager, the new image icon appears in

place of the image capture icon. Touch  **(Next)** after all images are captured.

- Touch **Save** to save the exam to the device or touch **Submit** to send the exam to the RetinaVue Network for a reading.

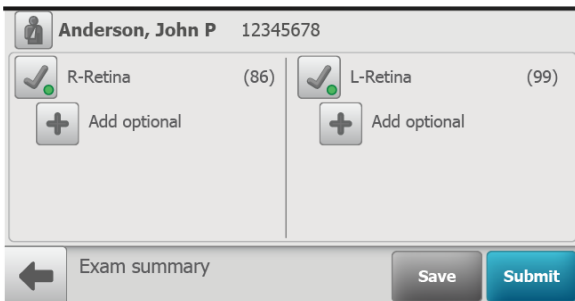

Review of saved exams

1. From the main *Patients* screen, touch .

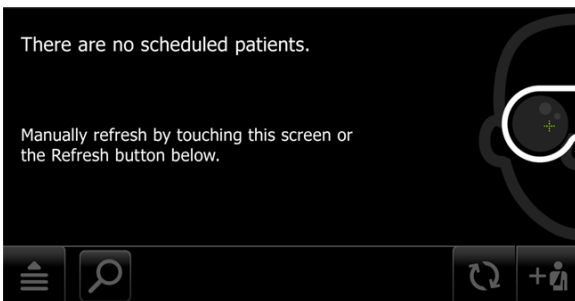

2. Touch **Review**.

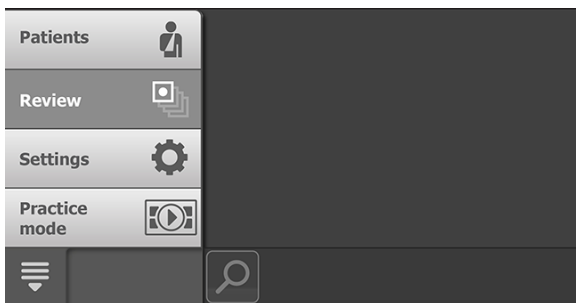

The patient's *Saved Review* screen appears.

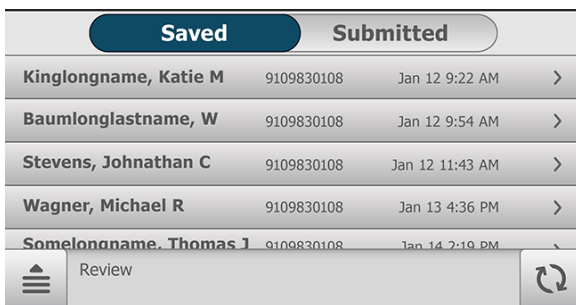

- Any exams which have not been sent for overread appear on the *Exam summary screen* (touch on a patient's name or ID to select that patient.) For Saved exams, touch on the image quality icon of the right or left eye to view the images associated with a patient.

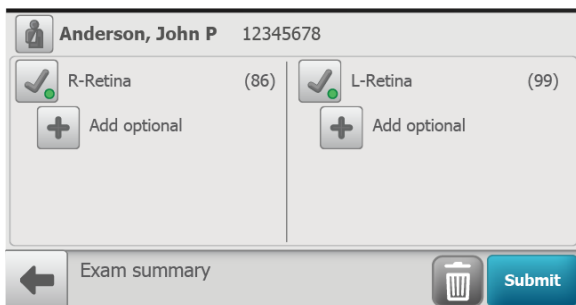

- After the review is complete, touch **Submit** to send the exam for overread.

Review of submitted exams

- From the main *Patients* screen, touch  .

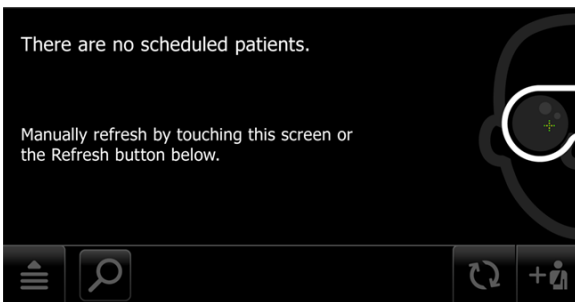

2. Touch **Review**.

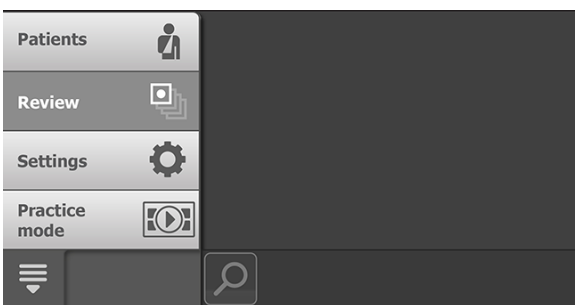

The patient's *Submitted/Review* screen appears.

Saved		Submitted	
Kinglongname, Katie M	9109830108	Jan 12 9:22 AM	
Baumlonglastn	Waiting to upload		
Stevens, Johnathan C	9109830108	Jan 12 11:43 AM	
Wagner, Michael R	9109830108	Jan 13 4:36 PM	
Somelongname, Thomas J	9109830108	Jan 14 2:19 PM	

Review

3. From the patient's *Submitted/Review* screen, touch one the following icons for additional status messages:

- Waiting to upload

- Submitted

- Report available





NOTE The status icons are only available in Wireless mode. Once an exam has been viewed on the RetinaVue Network Customer Portal it will be deleted from the device.

4. Touch  (Navigation Menu) and then touch **Patients** to return to the main *Patients* screen.

Update the RetinaVue 700 Imager software (firmware)

Take note of the current software version:

1. From the main *Patients* screen, touch .
2. Touch **Settings**.
3. Touch **About** to view the software version. (You may need to scroll down to see the About menu.)
4. Touch  (Back) to return to the *Settings* screen.

Before you begin, you will need the following :

- A computer with an Internet connection.
 - A USB cable to connect the RetinaVue 700 Imager to a computer.
 - The RetinaVue 700 Imager.
1. Download the software update from https://www.retinavue.net/RN_CustomerPortal/ and transfer the software update to a computer.

2. From the main *Patients* screen, touch .
3. Touch **Settings**.
4. Touch **Advanced settings**.
5. Touch **Firmware update**.
6. Touch **Load firmware**.
7. Touch **OK** at the prompt: "Use a USB cable to connect the camera to the computer to transfer the new firmware to the camera."
8. Plug the USB cable into the computer and the RetinaVue 700 Imager.

The screen prompt appears: "Camera plugged into computer. When finished loading file, unplug camera from the computer."

9. Keep the RetinaVue 700 Imager plugged into the computer and transfer the firmware update from the computer to the RetinaVue 700 Imager by

copying or dragging the file from the computer location into the RetinaVue 700 Imager device drive.



NOTE (In this example, "DATA (E:)".)

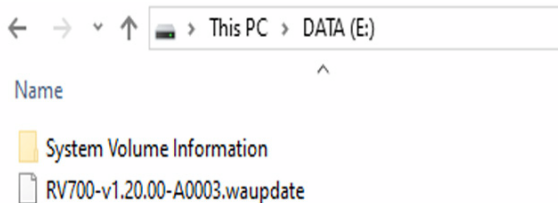

NOTE Use a safe eject method when ejecting the RetinaVue 700 Imager to ensure a complete firmware transfer to the RetinaVue 700 Imager . (Options include right-clicking on the *Start Menu > Open File Explorer> right-click on DATA , click Eject*. Or, click on the *Taskbar> Show hidden icons > click Safely Remove Hardware and Eject Media> click Eject RetinaVue Imager*. If an eject menu is not available with your system settings, wait until the files have completely copied before manually ejecting the RetinaVue 700 Imager .

10. Remove the USB cable from the RetinaVue 700 Imager.
11. Touch **OK** at the prompt: "*Install firmware*".





NOTE The update process typically takes a few minutes to cycle through the complete update. During the update process, it is normal to see a process update icon



that appears while the RetinaVue 700 Imager update successfully completes.

12. Touch **OK** at the prompt: "*Firmware update successful. Touch OK to restart the device.*"
13. After the RetinaVue 700 Imager boots up to the main *Patients* screen, confirm the software update.



- a. From the main *Patients* screen, touch  .
 - b. Touch **Settings**.
 - c. Touch **About** to view the software version.
14. Touch  (Back) to return to the *Settings* screen.

Install firmware when scheduled on the RetinaVue 700 Imager



NOTE This is an optional service that is available for purchase. Please contact your Hillrom representative for more information.

1. From the main Patients screen (or the currently active screen), if an firmware update is available, touch **OK** to install the update in the background.

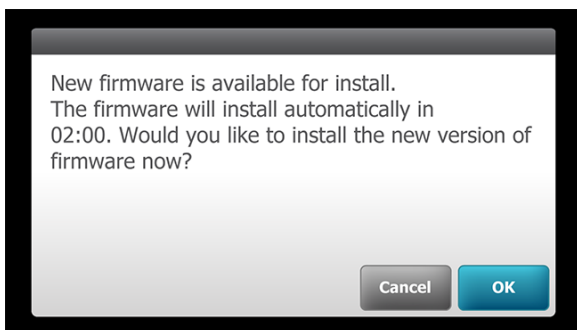

NOTE Do not power off the device. Sleep mode timer must be set to "Never". Device battery charge must be greater than 90 percent .



NOTE Once the firmware update progress has begun do not interrupt the update.

2. As the install occurs the "Firmware update in progress..." message appears.

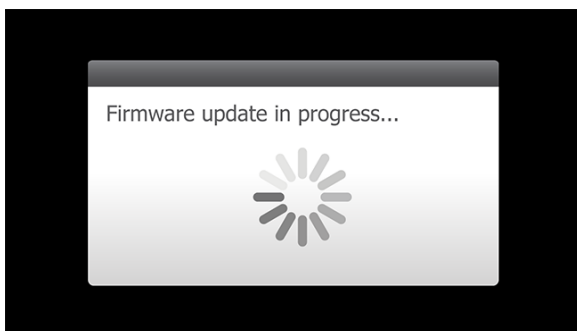



NOTE The update process typically takes a few minutes to cycle through the complete update. During the update process, it is normal to see a process update icon



that appears while the RetinaVue 700 Imager update process is occurring.

Controls

RetinaVue 700 Imager main *Patients* screen

The RetinaVue 700 Imager main *Patients* screen includes the following areas:

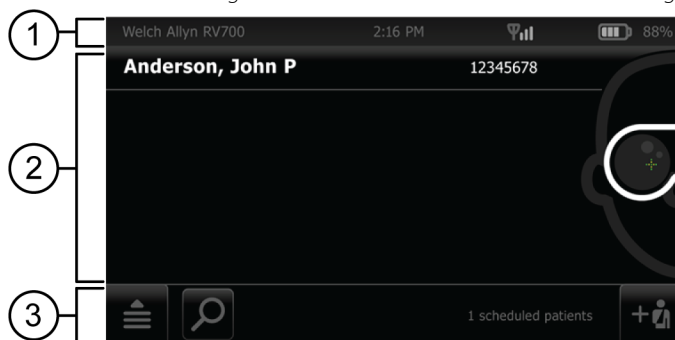

Item	Area
1	Device status
2	Patients list or Content Area
3	Navigation

1. Device Status Area

The Device Status Area, located at the top of the main *Patients screen*, displays the following:

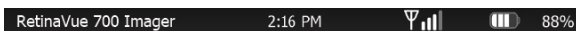

- Device Model (if in USB workflow)
- Clinic Name (if in Wi-Fi workflow and the clinic is selected at the RetinaVue Network Customer Portal). The clinic text indicates which clinic is selected.
- Time. Displayed in an HH:MM format.
- Connection status. The icons indicate which connection type, if any, is currently active. ( Wireless signal strength)
- Battery condition. Percentage of charge is displayed.

In the *Live Preview and Exam Summary* screens, the Device Status Area displays:

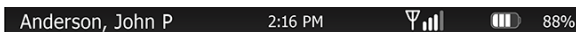

- Patient Icon and Patient name. The format of the Patient name is last name, first name, and middle initial.
- Clinic Name (The clinic text indicates which clinic is selected once it is entered at the RetinaVue Network Customer Portal). The Clinic Name only displays until a patient is selected.
- Time. Displayed in an HH:MM format.
- Connection status. The icons indicate which connection type, if any, is currently active.
- Battery condition. Percentage of charge is displayed.

2. Patients list/Content Area

At the main *Patients* screen, the **Context Area** shows patients.



The pop-up navigation menu provides access to the *Patients*, *Review*, *Settings*, and *Practice mode* menus within the **Context Area** of the RetinaVue 700 Imager user interface.

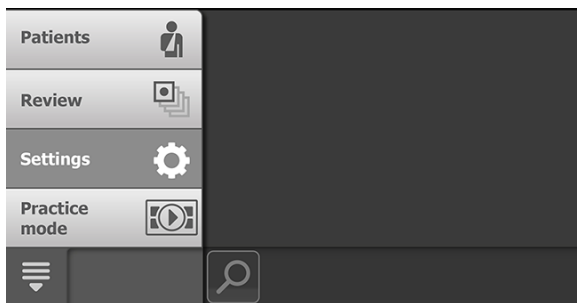







- **Patients:** Presents a list of patients created on the RetinaVue 700 Imager or transferred from the RetinaVue Network (requires Wi-Fi connection to the RetinaVue Network or an additional software application).
- **Review:** Presents images and exams from a list of patients contained on the RetinaVue 700 Imager.
- **Settings.** Provides controls to view or change the following in the Wi-Fi configuration:
 - Wi-Fi Off/On
 - Wi-Fi
 - Clinic/States
 - Device defaults
 - Volume
 - Sleep mode
 - Date & time
- **Advanced settings** (Wi-Fi configuration):
 - Advanced settings code
 - Date & time
 - Firmware update
 - Reset factory defaults
 - Service connection
 - Static IP Config
 - Export log
 - Recovery time
- **Settings.** Provides controls to view or change the following in the USB configuration:
 - Device defaults
 - Volume
 - Sleep mode
 - Date and time



- **Advanced settings** (USB configuration):
 - Device access code
 - Advanced settings code
 - Firmware update
 - Reset factory defaults
 - Export log
 - Recovery time
- About
 - Software version
- Regulatory Information
- Network Information
- Open source software information
- **Practice mode:** Provides interactive training help to practice the steps necessary to master the RetinaVue 700 Imager.

3. Navigation Area

In the Wi-Fi workflow, the Navigation Area, located at the bottom of the main *Patients screen*, displays the items listed below.

- **Navigation menu.** Touch  and then touch **Patients** to navigate to the *Patients* menu, or touch **Review** to navigate to the *Review* menu, or touch **Settings** to navigate to the *Settings* menu, or touch **Practice mode** to navigate to the *Practice* menu. (See **Content Area** or **Patients list** for further details).
- **Search.** Touch  to navigate to the *Patient list search* or the *Saved/Submitted Review* menus.
- **Refresh.** Touch  to see new patients downloaded from the RetinaVue Network Customer Portal. Wi-Fi Connection must be active and the RetinaVue 700 Imager must be connected to the RetinaVue Network Customer Portal.
- **Create new patient.** Create a new patient on the RetinaVue 700 Imager. Touch , if available, to navigate to the *Patient summary* screen.
- **Next.** Navigation to the next screen .
- **Exit.** One touch exit .

In the USB workflow, the Navigation Area, located at the bottom of the main *Patients screen*, displays the:

- Navigation menu.** Touch  and then touch **Patients** to navigate to the *Patients* menu, or touch **Review** to navigate to the *Review* menu, touch **Settings** to navigate to the *Settings* menu, or touch **Practice** to navigate to the *Practice* menu. (See **Content Area** or **Patients list** for further details). Touch  to return to main *Patients* screen.
- Create new patient.** Create a new patient on the RetinaVue 700 Imager. Touch  to navigate to the *Patient summary* screen.

Device Status Area in Practice mode

The Device Status Area in Practice mode is located at the top of the main *Patients* screen and is colored blue. It prominently displays "Practice mode" and it also contains the time and the battery condition.

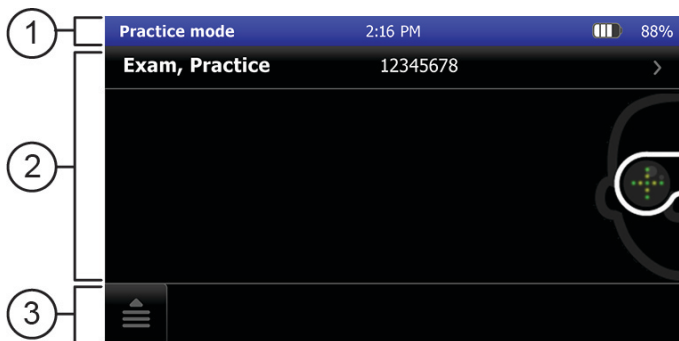

Item	Area
1	Device status colored blue
2	Single patient "Exam, Practice"
3	Navigation — touch Patients, Review, or Exit

Practice mode



CAUTION Exiting Practice mode deletes all exams. Data deleted on the device cannot be recovered.

- From the main *Patients* screen, touch .

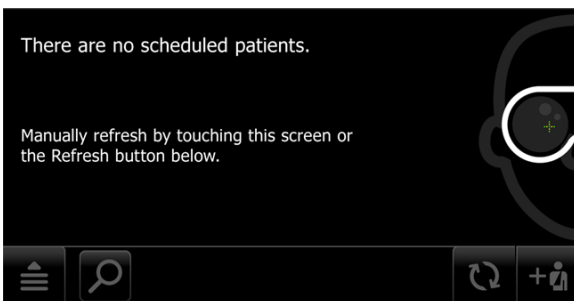

2. Touch **Practice mode** to enter Practice mode.

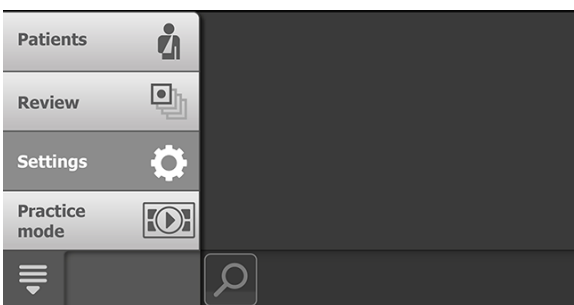

Touch **OK** at the prompt: "Active Practice mode. Not intended for patient exams." The *Practice mode* screen appears. Practice mode prominently displays the text "Practice mode" and a blue banner also appears at the top of the screen.

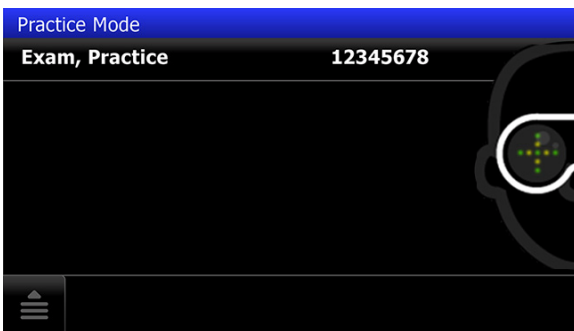

3. Touch on the "Exam, Practice" patient name or the patient number (12345678) to begin practicing with a patient exam.
The *Practice mode Patient summary* screen appears.
4. Touch **Exam**.

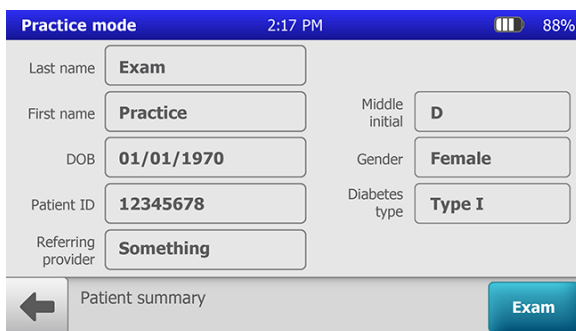

5. Touch **START EXAM**.



6. Position the RetinaVue 700 Imager about 4 inches directly in front of a practice patient, or a colleague. Keep the RetinaVue 700 Imager **level** and **in line** with your patient's eyes. Brace your arms against your body to help keep the RetinaVue 700 Imager steady.
7. Move the RetinaVue 700 Imager toward the patient and align the yellow circle to the patient's right pupil.

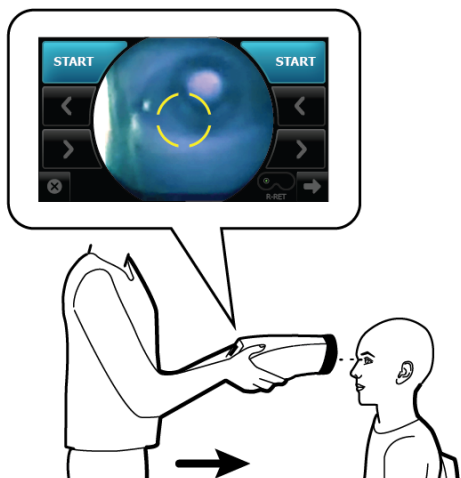

8. Place the face cup firmly on the patient's face. Do not hover near the face with the RetinaVue 700 Imager. Keep the RetinaVue 700 Imager level.

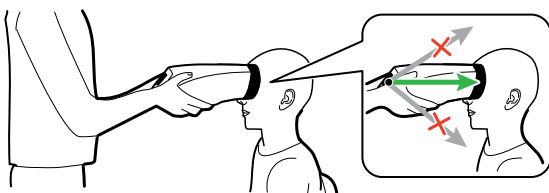

NOTE After placing the face cup firmly on the patient's face, the right pupil should be visible within the screen.

9. If the pupil is located above or below the yellow circle, as shown, slide the RetinaVue 700 Imager **slightly** up or down on the patient's face to align the yellow circle to the pupil.

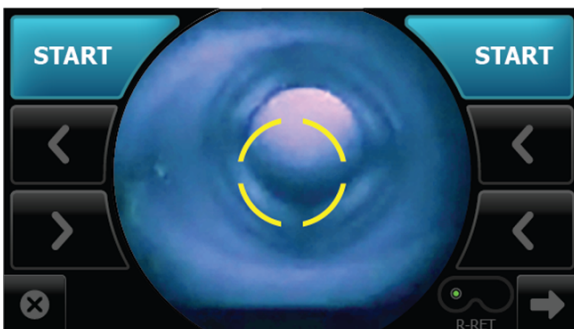

10. If needed, touch < or > to align the yellow circle to the pupil.

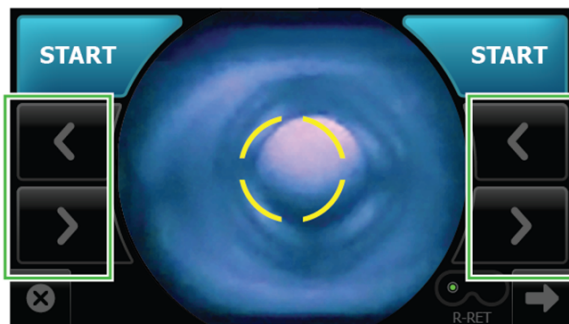

11. Ask the patient "Can you see the **entire** plus sign?". Inform the patient that the plus sign will transition into a green dot. Ask the patient to follow the green dot.

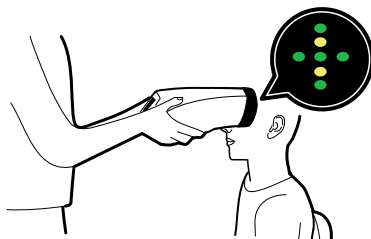

12. Press the face cup firmly against the patient's face and then touch **START**.

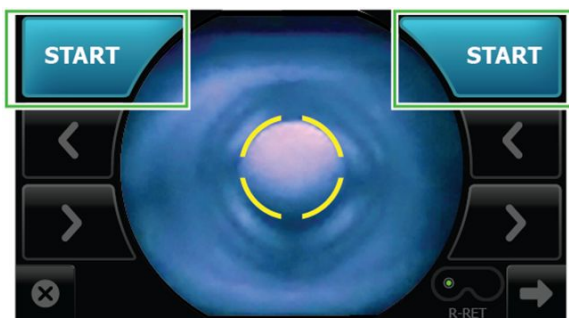

- 13. Hold steady until the image is captured.



- 14. If the audio volume is set to an audible level, a camera shutter tone alerts you once the right eye image has been captured.

A timer appears and counts down. This wait time allows the patient's eyes to recover from the flash. After the timer ends, the RetinaVue 700 Imager automatically moves to the left eye and the message: "Lens moving to the next eye." appears.
- 15. Repeat the steps to align the yellow circle to the pupil and capture an image of the left eye.
- 16. If the audio volume is set to an audible level, a camera shutter tone alerts you once the left eye image has been captured.
- 17. Once both images have been captured, the acquired images are available to view on the *Post Acquisition* screen.

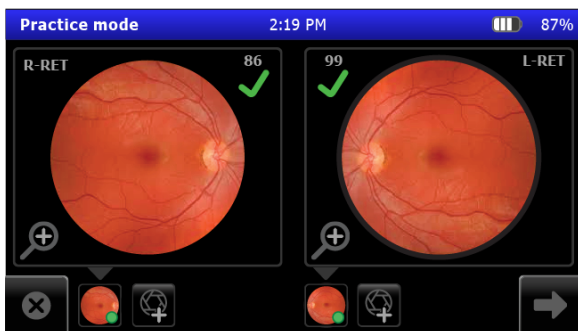

18. Touch **Save**.

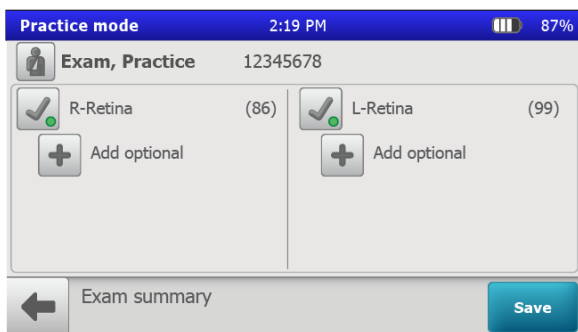

The exam appears as "Exam, Practice" on the *Review* screen.

19. Touch on the Patient's name ("Exam, Practice") or ID ("12345678") to return to the *Review* screen and to view images associated with your practice patient.



CAUTION No data is preserved in practice mode. Any data collected in practice mode will be deleted when Practice mode is exited and cannot be recovered.

- 20. When you complete your practice exam, touch  and then touch **Exit**.
- 21. Touch **OK** at the prompt: "Are you sure you want to exit practice mode?" to leave *Practice mode* and to return to the main *Patients* screen.

Select or change a clinic on the RetinaVue 700 Imager (wireless only)

- 1. From the main *Patients* screen, touch  (**Navigation Menu**).

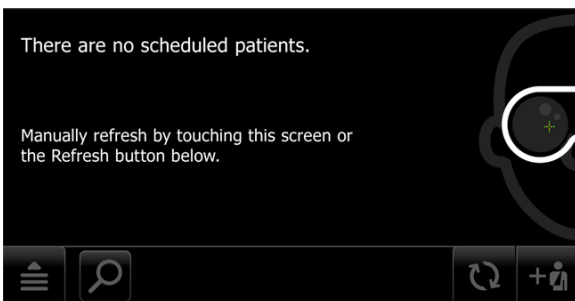

2. Touch **Settings**.

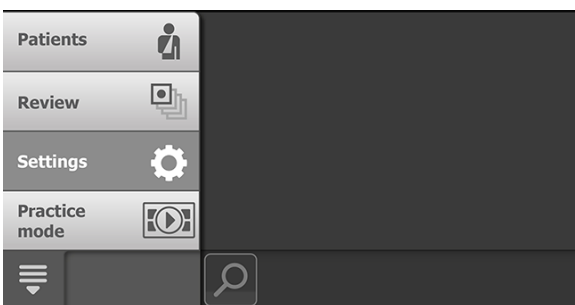

3. Touch **Clinic/States**.





NOTE With saved exams on the camera, switching a clinic is not permitted. Either save or delete the exam to switch clinics.



NOTE If the "Wi-Fi connection not available.", or the "No RetinaVue Network connection. To switch clinics, reconnect to RetinaVue Network." messages appear, see the *Troubleshooting* section.

4. Use the drop-down menu to select a clinic.



5. Touch  (Back) to return to the *Settings* screen.
6. Touch  and then touch **Patients** to return to the main *Patients* screen.

Select or change a Multi-State clinic on the RetinaVue 700 Imager (wireless only)

1. From the main *Patients* screen, touch  (**Navigation Menu**).

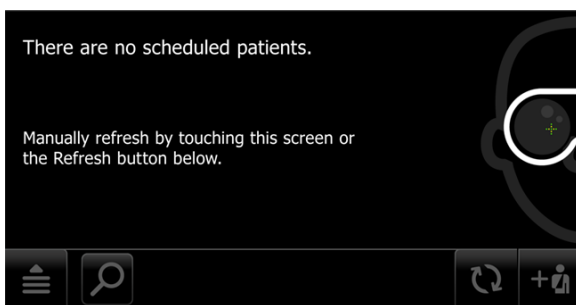

2. Touch **Settings**.

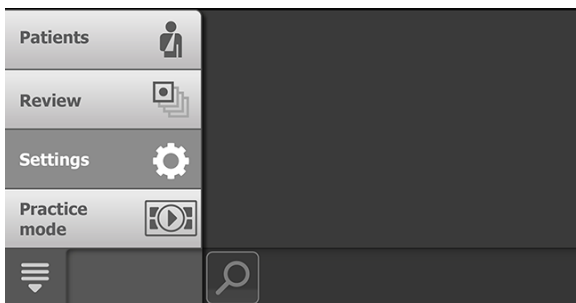

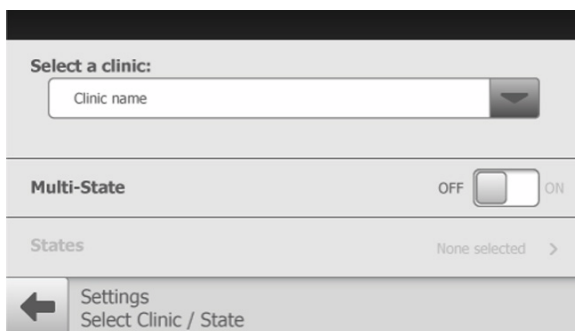

3. Touch **Clinic/States**.
4. If multiple clinics are set up, use the drop-down menu to select the clinic you would like to set up for Multi-State use.
5. Touch **Multi-State**. The switch changes from Off to On.

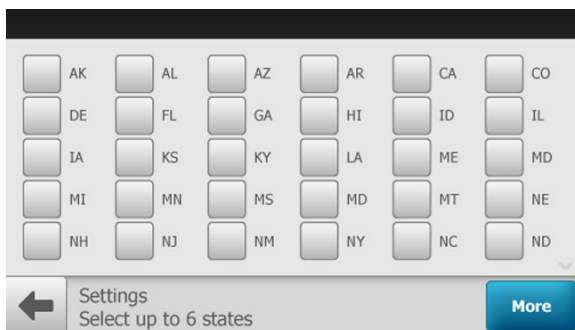

6. Touch **States** to select between 2 and 6 States for the clinic. Touch **More** to see additional States and to proceed to OK when the desired number of States are selected.



7. Touch **OK** to return to the *Settings Select clinic/states* screen.
8. Touch  (Back) to return to the *Settings* screen.
9. Touch  and then touch **Patients** to return to the main *Patients* screen.



NOTE For each exam performed in multi-state use, select the state where the exam was performed. Touch **OK** to confirm.

View or change the RetinaVue 700 Imager settings

From the main *Patients* screen, touch  (Navigation Menu) to view or change the settings.

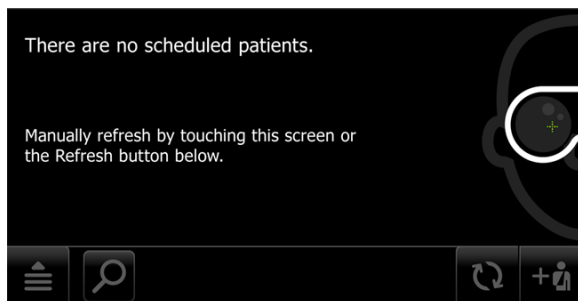

Touch **Settings** and then modify the settings as desired.

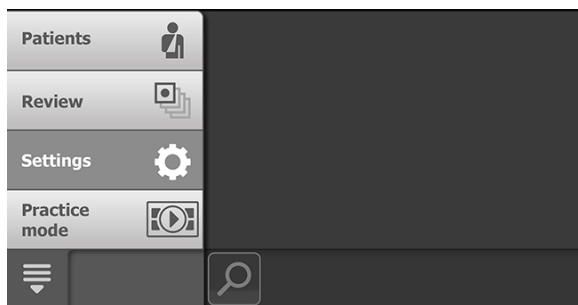











In the Wi-Fi workflow:

- Touch **Wi-Fi Off/On**.
 - Touch "OFF" or "ON" to turn the wireless radio off or on.
- Touch **Wi-Fi** to view or reset available Wi-Fi networks. The list of available wireless networks in range appears. The currently selected network appears with a checkmark next to the network name.
 - Touch > to view or modify the wireless network settings from the list of available wireless networks in range. Touch ← (Back) to return to the *Wi-Fi Setup* screen
 - Touch **Info** to view network information. The *Network Information* screen appears:
 - MAC address 00:17:23:e5:d5:a5**
 - IP address 10.20.200.70**
 - Subnet mask 244.244.244.1**
 - Gateway 10.20.244.1**
 - Version 2.00.02**

SSID (Your Network)**Access Point MAC B2:DE:31:OC:32:B2****RSSI -70**

Touch  (Back) to return to the *Wi-Fi Setup* screen.

- Touch . The *Wi-Fi Radio settings* screen appears. See *Troubleshooting* for more information on updating Wi-Fi Radio settings. Touch  (Back) twice to return to the main *Settings* screen.
- Touch **Clinic/States**. Up to 6 States may be selected for a clinic.
 - Touch **Multi-State**. The switch changes from Off to On.
 - Touch **States**. Touch the box next to the State abbreviation to select it.
 - Touch **More**. Touch **OK**.
 - Touch  (Back) twice to return to the main *Settings* screen.
- Touch **Device defaults**
 - Touch  (up) or  (down) to adjust the device sound volume. Touch  (Back) to return to the main *Settings* screen.
 - Touch  (down) to adjust the device sleep time. Use the scroll bar to select 5 minutes, 7 minutes, 10 minutes, or Never. Touch  (Back) to return to the main *Settings* screen.
- Touch **Date & time**.
 - Touch  (up) or  (down) to adjust the hour, minute, Continent, and Location. Use the radio buttons to select the 24-hour or 12-hour format. Touch  (Back) to return to the *Settings* screen.



NOTE If the up and down controls are not functional, NTP may be enabled. To disable NTP, see *Adjust NTP date and time settings* in the *Advanced features* section of this document.

- Touch **Advanced settings** and then modify the settings as desired.
 - **Advanced settings code.** Set the Advanced settings numeric code, retype the code to confirm, and touch **OK** to return to the *Advanced settings screen*.
 - **Firmware update.** Touch **Load firmware** and touch **OK** at the prompt to load the software from a computer.
 - **Reset factory defaults.** For Wi-Fi, touch **Restore Settings** and then touch **OK** to reset the device to the default setting.
 - **Service connection.** For Wi-Fi, at the "Sync with service server" screen, touch **Sync now** to test the operation of synchronization and then touch **OK** at the "Sync with server is complete." prompt to show the time of the last successful sync. The last successful sync appears on the screen. Touch  (Back) to return to the *Advanced Settings screen*.
 - **Network Time Protocol (NTP).** For Wi-Fi, touch Date & time. Then, touch the box next to "Enable NTP" to either add a check mark, enabling NTP, or remove a check mark, disabling NTP.
 - **Static IP Config.** Touch **Static IP Config** to view or reset the Device IP. The list of current IP address, Subnet mask, Gateway, and DNS appears on the *Wi-Fi Device IP* screen.



Touch **DHCP** to view or modify the device IP settings. Use the drop-down menu to select **Static IP** in the left pane. Touch within the *IP address*, *Subnet mask*, *Gateway*, or *DNS* fields to launch the onscreen numeric keypad and to change the information in any of the associated

fields, then touch **OK** on the numeric keypad. Touch **Apply** to save changes.

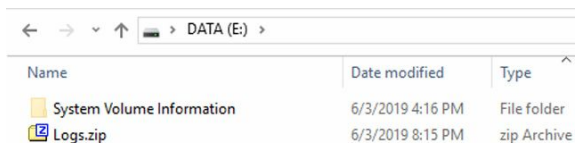

Touch  (Back) to return to the *Advanced Settings* screen if necessary. The camera may automatically load the *Advanced Settings* screen.

- **Export log.** Touch **Export log** to export logs into a viewable zip file. Touch **OK** at the prompt: *"The log files are available for export. Use a USB cable to connect the camera to the computer to export files. When finished copying the file, unplug camera from the computer."* After the RetinaVue 700 Imager is connected to a computer by the USB cable, navigate to the drive ["DATA (E:)" in the sample screen] and copy the compressed zip file to a location on the computer where the files can be viewed in a text file.









Name	Date modified	Type
 System Volume Information	6/3/2019 4:16 PM	File folder
 Logs.zip	6/3/2019 8:15 PM	zip Archive

Touch  (Back) to return to the main *Settings* screen.

- **Network information.** Touch **Network information** to view the wireless radio (Wi-Fi) MAC address, IP address, Subnet mask, and Gateway addresses. Touch  (Back) to return to the main *Settings* screen.
- Touch **About** to view the software version. Touch  (Back) to return to the main *Settings* screen.
- **Regulatory information.** Touch **Regulatory information** to view Regulatory Information. Touch  (Back) to return to the main *Settings* screen.
- **Open source.** Touch **Open source** to view this open source information message: *"This product may contain software known as "free" or "open source" software (FOSS). Welch Allyn uses and supports the use of FOSS. We believe that FOSS makes our products more robust and secure, and gives us and our customers greater flexibility. To learn more about FOSS that may be*

used in this product, please visit our FOSS website at <http://www.welchallyn.com/opensource>. Where required, a copy of FOSS source code is available on our FOSS website." Touch  (Back) to return to the main *Settings* screen.



In the USB workflow:

- Touch **Device defaults**.
 - Touch  (up) or  (down) to adjust the device sound volume.
 - Touch  (down) to adjust the device sleep time. Use the scroll bar to select 5 minutes, 7 minutes, 10 minutes, or Never.
Touch  (Back) to return to the main *Settings* screen.
- Touch **Date & time**.
 - Touch  (up) or  (down) to adjust the Day, Month, Year, Hour, Minute (Min), Continent, and Location. Use the radio buttons to select the 24-hour or 12-hour format. Touch  (Back) to return to the main *Settings* screen.
- Touch **Advanced settings**.
 - **Device access code**. Set the Device access numeric code, retype the code to confirm, and touch **OK** to return to the *Advanced settings* screen (USB only).
 - **Advanced settings code**. Set the Advanced settings numeric code, retype the code to confirm, and touch **OK** to return to the *Advanced settings* screen.
 - **Firmware update**. Touch **Load firmware** and touch **OK** at the prompt to load the firmware from a computer.
 - **Reset factory defaults**. Touch **Restore Settings** at the prompt: "Do you want to restore to factory defaults? This will rest all device settings. Any saved exams on this camera will be deleted." Touch **OK** at the prompt: "Reset all settings to defaults? Any saved exams on this camera will be deleted."

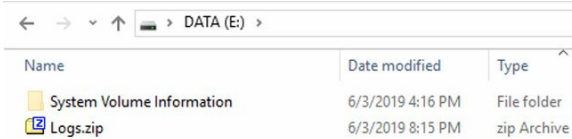
- **Export log.** Touch **Export log** to export logs into a viewable zip file. Touch **OK** at the prompt: *"The log files are available for export. Use a USB cable to connect the camera to the computer to export files. When finished copying the file, unplug camera from the computer."* After the RetinaVue 700 Imager is connected to a computer by the USB cable, navigate to the drive ["DATA (E:)" in the sample screen] and copy the compressed zip file to a location on the computer where the files can be viewed in a text file.



Touch  (Back) to return to the main *Settings* screen.

- Touch **About** to view the software version. Touch  (Back) to return to the *Settings* screen.
- **Regulatory information.** Touch **Regulatory information** to view Regulatory Information. Touch  (Back) to return to the main *Settings* screen.
- **Open source.** Touch **Open source** to view this open source information message: *"This product may contain software known as "free" or "open source" software (FOSS). Welch Allyn uses and supports the use of FOSS. We believe that FOSS makes our products more robust and secure, and gives us and our customers greater flexibility. To learn more about FOSS that may be used in this product, please visit our FOSS website at <http://www.welchallyn.com/opensource>. Where required, a copy of FOSS source code is available on our FOSS website."* Touch  (Back) to return to the main *Settings* screen.

Power down the RetinaVue 700

1. Press .
2. A dialogue box appears with three options:

- Power down
- Sleep
- Cancel

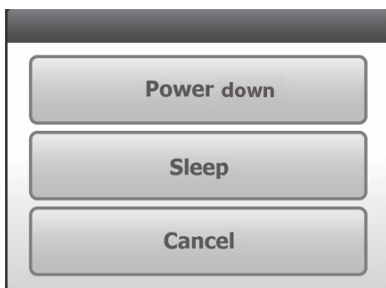

3. Touch **Power down**.

Enter Sleep mode

1. Press .
2. A dialogue box appears with three options:
 - Power down
 - Sleep
 - Cancel

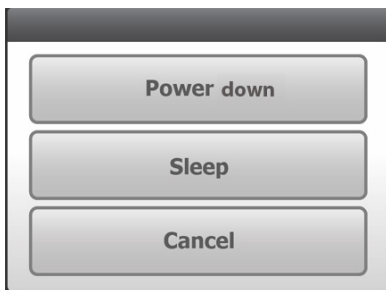

3. Touch **Sleep**.
The RetinaVue 700 enters Sleep mode.

Exit sleep mode

1. Press  or touch the LCD touchscreen.





NOTE Lifting or moving the RetinaVue 700 Imager also brings the RetinaVue 700 Imager out of Sleep mode.

2. After performing one of the options, the RetinaVue 700 Imager will awaken from Sleep mode and return to the prior screen.

Set the date and time



1. Follow the steps in the *Battery installation and replacement* section to install the battery and then press and hold the power button  to turn the device on.



2. Touch  (Navigation Menu) and then touch **Settings** on the RetinaVue 700 Imager main *Patients* screen.
3. Touch **Date and time**.
4. Touch  (up) or  (down) to adjust the day, month, and year in the DD/MM/YY format.



NOTE If the up and down controls are not functional, NTP may be enabled. To disable NTP, see *Adjust NTP date and time settings* in the *Advanced features* section of this document.

5. Touch  (up) or  (down) to adjust the hour, minute, and use the drop-down menu  and scroll bar to view or change the Continent and location.



NOTE Use the radio buttons to select the 24-hour or 12-hour format.

6. Touch  (Back) to return to the *Settings* screen.



Set the Device access code at the RetinaVue 700 Imager (USB only)



NOTE Setting the Device access code before first use provides additional security features in the RetinaVue 700 Imager to prevent unintended access to patient information by unauthorized individuals.





NOTE See *First time selection of Wi-Fi connectivity workflow* for instructions on setting the Device access code on the RetinaVue 700 Imager from the RetinaVue Network Customer Portal.

1. If not already powered on, press and hold the power button  to turn the RetinaVue 700 Imager on.
2. From the main *Patients* screen, touch  (Navigation menu).
3. Touch **Settings**.
4. Touch **Advanced settings**.
5. Touch **Device access code** to enter an access code for the RetinaVue 700 Imager.
6. Use the touchscreen numeric keypad to enter an access code into the *Access code* field and then retype the same code into *Access code (retype)* field.



NOTE The access code password can contain a minimum of 1-digit and a maximum of 18-digits. Characters are only numeric from 0 through 9.

7. Touch **OK** to accept the code and touch **OK** again at the confirmation screen to return to the *Advanced settings* screen.
8. Touch  (Back) to return to the *Settings* screen.
9. Touch  (Navigation menu) and **Patients** to return to the *Patients* home screen.

Reset the Device access code (USB only)



1. If you are not already logged in, enter the existing access code for the RetinaVue 700 Imager.
2. From the main *Patients* screen touch  (Navigation menu).
3. Touch **Settings**.
4. Touch **Advanced settings**.
5. Touch **Device access code**.
6. Touch **Reset** to clear the existing access codes.
7. Use the touchscreen numeric keypad to enter an access code into the *Access code* field and then retype the same code into the *Access code (retype)* field.



NOTE The access code password can contain a minimum of 1-digit and a maximum of 18-digits. Characters are only numeric from 0 through 9.



NOTE Alternatively, after the code reset, touch **OK**, and then touch **OK** again at the confirmation screen to return to the *Advanced settings* screen without using a Device access code.

8. Touch **OK** to accept the code and touch **OK** again at the confirmation screen to return to the *Advanced settings* screen.
9. Touch  (Back) to return to the *Settings* screen.
10. Touch  (Navigation menu) and **Patients** to return to the *Patients* home screen.

Company and Clinic Administrators

Set the Device access code at the RetinaVue Network Customer Portal (Wi-Fi only)



NOTE Setting the Device access code before first use provides additional security features in the RetinaVue 700 Imager to prevent unintended access to patient information by unauthorized individuals.



NOTE Company and Clinic administrators can set the Device access code on the RetinaVue 700 Imager from the RetinaVue Network Customer Portal.

1. On the RetinaVue Network Customer Portal, enter your RetinaVue Network Username and Password then click **Log In**.



- 2. On the RetinaVue Network Customer Portal, select *Manage Devices* and click **Next**.

Welcome to the RetinaVue Customer Portal



- 3. See the *Wi-Fi camera registration* topic if there are not currently any registered devices.

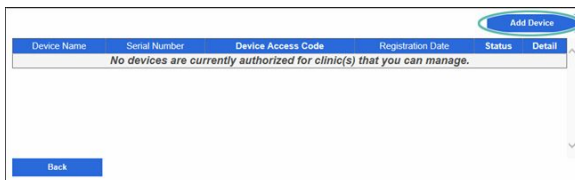

- 4. To enable a Device Access Code for the RetinaVue 700 Imager, click **Edit**.

Device Management Add Device

Device Name	Serial Number	Device Access Code	Registration Date	Status	Detail
RV700 SKF	700044180025		7/6/2020		Edit

- Select the **Device Access Code** checkbox and enter your code into the *Device Access Code* field. The RetinaVue 700 Imager and the RetinaVue Network Customer Portal support from 4 to 6-digits in the Device Access Code.

Edit Device

Device Name

Device Serial Number

Device Access Code

 ####

Select clinics to associate with this camera

- Select each clinic to associate the RetinaVue 700 Imager camera Device Access Code by clicking the check box next to each clinic name and then click **Save**.

Each RetinaVue 700 Imager camera at each clinic will receive a notification after start up or after coming out of sleep mode that: "A new device access code has been downloaded. The camera will require this code at the next encounter."

Reset the Device access code at the RetinaVue Network Customer Portal (Wi-Fi only)



NOTE Company and Clinic administrators can reset the Device access code on the RetinaVue 700 Imager from the RetinaVue Network Customer Portal.

- To enable a Device Access Code for the RetinaVue 700 Imager, click **Edit**.

Device Management Add Device

Device Name	Serial Number	Device Access Code	Registration Date	Status	Detail
RV700 SKF	700044180025		7/6/2020		Edit

- Select the **Device Access Code** checkbox and enter your revised code into the *Device Access Code* field. To remove an existing Device Access Code, click within the *Device Access Code* field and use the backspace key to delete information or select the entire code and use the delete key to remove all the code before entering the revised code. The RetinaVue 700

Imager and the RetinaVue Network Customer Portal support from 4 to 6-digits in the Device Access Code.

Edit Device

Device Name
RV700 SKF

Device Serial Number
700044180025

Device Access Code
123456 # # # #

[Select clinics to associate with this camera](#)

3. Select each clinic to associate the RetinaVue 700 Imager camera Device Access Code by clicking the check box next to each clinic name and then click **Save**.

Each RetinaVue 700 Imager camera at each clinic will receive a notification after start up or after coming out of sleep mode that: "A new device access code has been downloaded. The camera will require this code at the next encounter."



NOTE Inform each of the affected clinics of the code change via your company channels.

Invalid Device access code (Wi-Fi only)

1. Use the touchscreen numeric keypad to enter an access code into the *Device access code* field and then touch **OK**

The RetinaVue 700 Imager and the RetinaVue Network Customer Portal support from 4 to 6 digits in the Device Access Code. Characters are only numeric from 0 through 9. In the Wi-Fi workflow, the administrator sets these codes.

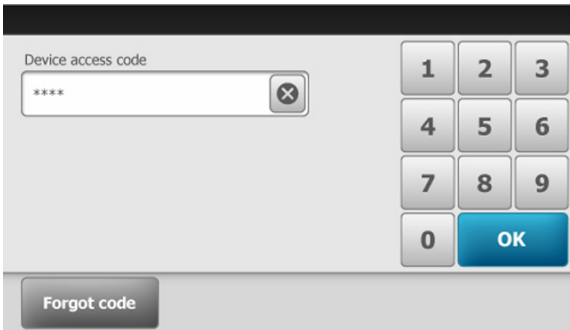

User Action	Message	Next Steps
Enter invalid code 1 time	<i>"Invalid code Contact your RetinaVue Network administrator to reset the code."</i>	Use the touchscreen numeric keypad to enter an access code into the Device access code field. If you need to reset the access code, contact your RetinaVue Network administrator.
Enter invalid code 2 times in a row	<i>"Invalid code Contact your RetinaVue Network administrator to reset the code."</i>	Use the touchscreen numeric keypad to enter an access code into the Device access code field. If you need to reset the access code, contact your RetinaVue Network administrator.
Enter invalid code 3 times in a row	<i>"Invalid code. Device locked. Try again in 2:00 Contact your RetinaVue Network administrator to reset the code."</i>	The keypad and the OK button are inactive and greyed out until the count down timer expires. Use the touchscreen numeric keypad to enter an access code into the Device access code field once the field is active. If you need to reset the access code, contact your RetinaVue Network administrator.
Enter invalid code 4 times in a row	<i>"Invalid code. Device locked. Try again in 10:00 Contact your RetinaVue Network administrator to reset the code."</i>	The keypad and the OK button are inactive and greyed out until the count down timer expires. Use the touchscreen numeric keypad to enter an access code into the Device access code field once the field is active. If you need to reset the access code, contact your RetinaVue Network administrator.

User Action	Message	Next Steps
Enter invalid code 5 times in a row	<i>"Invalid code. Device locked. Try again in 10:00"</i> <i>Contact your RetinaVue Network administrator to reset the code."</i>	The keypad and the OK button are inactive and greyed out until the count down timer expires. Use the touchscreen numeric keypad to enter an access code into the Device access code field once the field is active. If you need to reset the access code, contact your RetinaVue Network administrator.
Enter invalid code 6 times in a row	<i>"Invalid code. Device locked. Try again in 30:00"</i> <i>Contact your RetinaVue Network administrator to reset the code."</i>	The keypad and the OK button are inactive and greyed out until the count down timer expires. Use the touchscreen numeric keypad to enter an access code into the Device access code field once the field is active. If you need to reset the access code, contact your RetinaVue Network administrator.

Lost or forgotten access code?

Contact your RetinaVue Network administrator to reset the device access code from the RetinaVue Network Customer Portal.



NOTE If necessary, perform a factory reset to erase the code, however, any saved exams or patient data on the camera will be deleted. Touch **Forgot code** to perform a factory reset and then touch **Factory reset** to regain access to the device. A few prompts will appear, requesting you to confirm that you would like to continue with the factory reset. See the *Troubleshooting* topic for more information about resetting the Device access code.



CAUTION Data deleted on the device cannot be recovered.

(Optional). Touch **Forgot code** to perform a factory reset. Touch **Factory reset** at the confirmation screen to return to the RetinaVue 700 Imager set up work flow. Any saved exams or patient data on the camera will be deleted.



Set the Advanced settings code

1. If the RetinaVue 700 Imager is set with a Device access code (in addition to the Advanced settings code) and you are not already logged in, enter the existing Device access code.

2. From the main *Patients* screen, touch  (Navigation menu).
3. Touch **Settings**.
4. Touch **Advanced settings**.
5. Touch **Advanced settings code**.
6. Use the touchscreen numeric keypad to enter a code into the *Advanced settings code* field and then retype the same code into the *Advanced settings code (retype)* field and touch **OK** on the keypad.



NOTE The Advanced settings code password can contain a minimum of 1-digit and a maximum of 18-digits. Characters are only numeric from 0 through 9.

7. Touch **OK** again at the confirmation screen.
8. Touch  (Back) to return to the *Settings* screen.
9. Touch  (Navigation menu) and **Patients** to return to the *Patients* home screen.

Reset the Advanced settings code



NOTE Setting the Advanced settings code before first use provides additional security features in the RetinaVue 700 Imager Pro to prevent unintended access to advanced settings. Touch **Forgot Pin** if you cannot recall your RetinaVue 700 Imager Pro Advanced settings code and need to erase the Advanced settings code.



CAUTION Data deleted on the device cannot be recovered.



Touch **Factory reset** to regain access to the device. Any saved exams or patient data on the camera will be deleted.

1. If the RetinaVue 700 Imager Pro is set with a Device access code (in addition to the Advanced settings code) and you are not already logged in, enter the existing Device access code.
2. From the main *Patients* screen, touch  (Navigation menu).
3. Touch **Settings**, > **Advanced settings**.
4. Enter the existing Advanced settings code for the RetinaVue 700 Imager Pro and touch **OK** on the keypad.
5. Touch **Advanced settings code** again.

6. Touch **Reset** on the keypad and use the touchscreen numeric keypad to enter a code into the *Advanced settings code* field and then retype the same code into the *Advanced settings code (retype)* field and touch **OK** on the keypad.



NOTE The Advanced settings code password can contain a minimum of 1-digit and a maximum of 18-digits. Characters are only numeric from 0 through 9. Alternatively, touch **Reset** and touch **OK** on the keypad to clear the existing Advanced settings codes without using an Advanced setting code.

7. Touch **OK** again at the prompt: "*Removed Advanced settings code. Touch OK to confirm removal of this security feature.*".
8. Touch  (Back) to return to the *Settings screen*.
9. Touch  (Navigation menu) and **Patients** to return to the main *Patients screen*.

Adjust the wireless network settings

Follow the steps below to tell the RetinaVue 700 Imager to remember a wireless network, to tell the device to forget a wireless network, or to enter a new wireless network username or password.



NOTE The recommended network bandwidth is 1 Mbps in a low-latency environment. A network bandwidth of 0.5 Mbps or less may delay or prevent the transmission of images and results.

1. From the RetinaVue 700 Imager main *Patients* screen, touch  (Navigation Menu).
2. Touch **Settings**.
3. Touch **Wi-Fi**.
4. Touch the wireless network that you would like to adjust.
5. Enter the credentials for the network.

Two options appear at the bottom of the screen. The option on the right, **CONNECT**, will not allow you to change any settings and will, instead, connect the device to the network. The option on the left will provide one of a few different choices for adjusting the wireless network settings, as described in the table below.

Option	Purpose	User actions
SAVE	Allows the device to remember the network	<p>Touch SAVE to tell the device to remember the network.</p> <p>To confirm this action, touch OK at the prompt "Are you sure you want to remember this network?"</p> <p>To cancel the process and leave the network unremembered, touch CANCEL at the prompt.</p>
UPDATE	Allows you to change the network credentials	<p>Touch UPDATE to tell the device to remember a new username or password for a previously saved wireless network.</p> <p>To confirm this option, touch OK at the prompt "Are you sure you want to change the network credentials?"</p> <p>To cancel the process and leave the network credentials unchanged, touch CANCEL at the prompt.</p>

FORGET	Allows you to remove a wireless network from the list of remembered networks	To tell the device to forget the network, so that it no longer appears in the list of remembered networks, touch FORGET . To confirm this action, touch OK at the prompt "Are you sure you want to forget this network?" To cancel the process and leave the network remembered, touch CANCEL at the prompt.
--------	--	---

Advanced features

Manual exam mode

Manual Mode Use the RetinaVue 700 Imager in manual mode to acquire images in those instances when automatic capture mode is not suitable. Manual operation of the RetinaVue 700 Imager allows control of the lens barrel movement, focus, brightness, and image acquisition. The manual mode operation is an optional mode intended for advanced users who understand eye physiology. Manual mode may not be suitable for novice users. Two images of each eye are captured in Manual mode.

Right

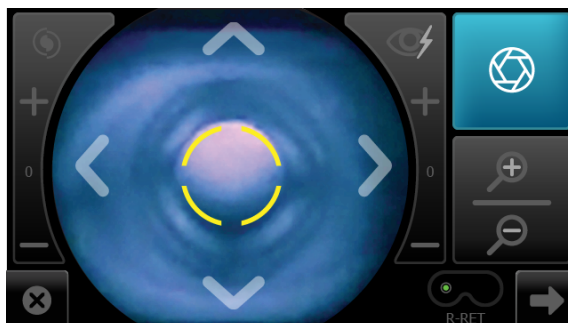

Left

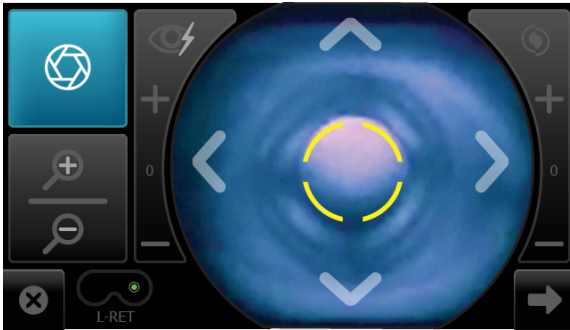

Manual mode contains advanced image capture options.



NOTE A manual touch of the capture button is required to obtain an image.

Available manual features include:

Focus adjustment (values range from -1 to +1)



Flash brightness adjustment (values range from -2 to +2)



Image capture



X-axis control (horizontal movement)



Y-axis control (vertical movement)



Zoom in/Zoom out



One touch exit



One touch advancement to next screen



An additional available manual feature is the Sequential image capture order of the right and left eye.

Perform a manual image capture



WARNING Clean and disinfect the face cup after each patient to avoid the risk of cross-contamination.

1. From the *Patients* screen, touch on the Patient's name or ID (MRN).



Any scheduled patients appear on the *Patients* screen. (Wireless workflow images shown)

2. Touch **Exam** to open a new exam.

Last name	Anderson	Middle initial	P
First name	John	Gender	Male
DOB	05/12/1962	Diabetes type	Type II
Patient ID	12345678	Referring provider	Murphy, Ryan MD

← Patient summary
Delete
Exam

- From the *Pre Acquisition* screen, touch on the default protocol **Retina**  to launch the *Exam protocol selection*.









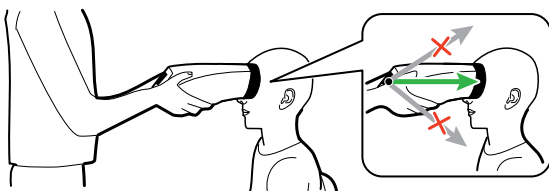

- From the *Exam protocol selection* screen, touch **Manual**.



NOTE To adjust settings before capturing an image, see the topic *Manual Exam mode* for additional information about using advanced image capture options (such as Focus adjustment, Flash brightness adjustment, or X-axis and Y-axis adjustment).



- Position the RetinaVue 700 Imager about 4 inches directly in front of the your patient. Keep the RetinaVue 700 Imager level and in line with your patient's eyes. Brace your arms against your body to help keep the RetinaVue 700 Imager steady.
- Place the face cup firmly on the patient's face. Do not hover near the face with the RetinaVue 700 Imager. Keep the RetinaVue 700 Imager level.

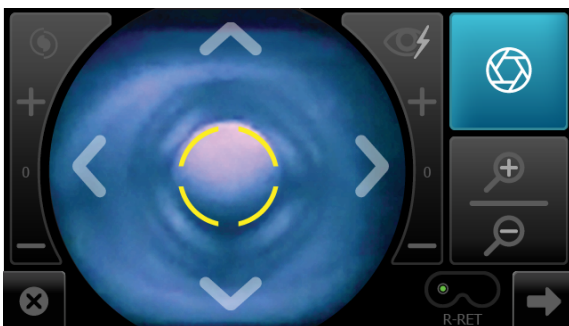

7. Move the RetinaVue 700 Imager toward the patient and align the yellow circle to the patient's right pupil.
8. Hold the RetinaVue 700 Imager steady and in line and use the touchscreen X-axis control   for horizontal movement, or the Y-axis control   for vertical movement to align the patient's right pupil in the oval.
9. While aligning the yellow circle to the patient's right pupil, also use the   zoom functionality to navigate the lens barrel towards the patient's eye until the retina comes into view.
10. Once the retina comes into view, continue to use the manual adjustment as needed while looking for a white circular reflection at the top of the eye's image on the LCD touchscreen.
11. Touch  (image capture) to manually capture an image of the right eye. (Right eye manual capture shown.)



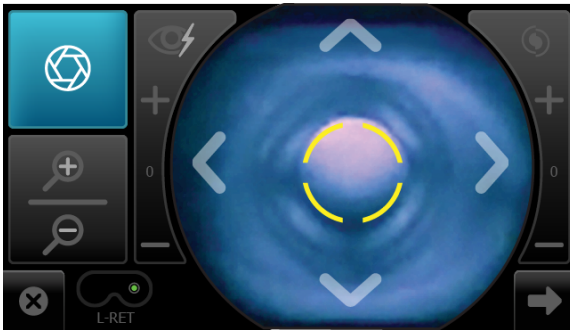

If the audio volume is set to an audible level, a camera shutter tone alerts you that an image has been captured. A timer appears and counts down. This wait time allows the patient's eyes to recover from the flash.

12. Repeat steps 7 through 11 as needed and touch  (image capture) to manually capture a second image of the right eye once the yellow circle is aligned to the patient's right pupil.
13. Repeat steps 7 through 11 as needed for the left eye and touch  (image capture) to manually capture an image of the left eye once the yellow circle is aligned to the patient's left pupil. (Left eye manual capture shown.)



The acquired images appear on the *Post Acquisition* screen after a few seconds.

14. Repeat steps 7 through 11 as needed and touch  (image capture) to manually capture a second image of the left eye once the yellow circle is aligned to the patient's left pupil.
15. Touch  (Next) after all images are captured.

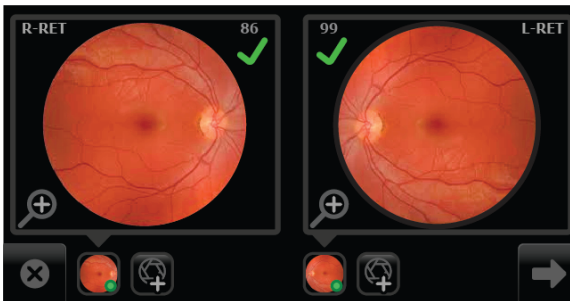

The *Exam summary* screen appears.

16. From the *Exam summary* screen, if the images contain a green or yellow quality acceptance check mark:

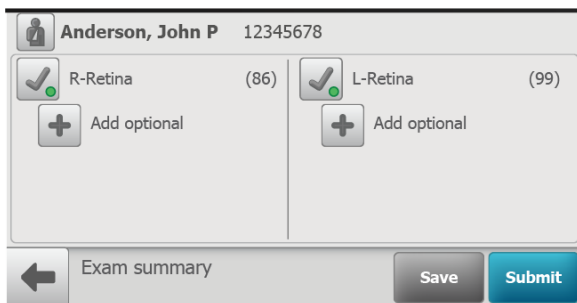

- a. Touch **Save** to save the exam to the device for further review or editing.
- b. Touch **Submit** to submit the exam to the RetinaVue Network Customer Portal.

Use the Anterior Imaging Spacer for a patient Anterior image exam



NOTE The Anterior Imaging Spacer is an available accessory for the RetinaVue 700 Imager.

1. When performing Anterior imaging of the ocular structures (lids, lashes, and cornea) using the Anterior protocol, remove the face cup from the RetinaVue 700 Imager,

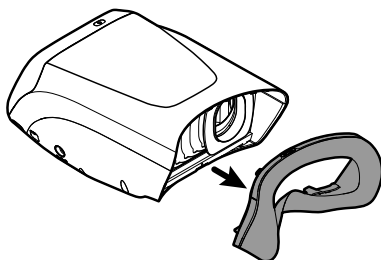

attach the Anterior Imaging Spacer to the RetinaVue 700 Imager, and then attach the face cup to the Anterior Imaging Spacer.

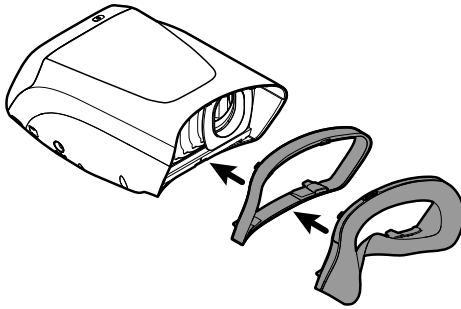

CAUTION Failure to install the Anterior Imaging Spacer before an Anterior image exam may result in unacceptable image quality or failure to capture an image.

2. From the *Pre Acquisition* screen, touch  (**Settings**) to select the Anterior protocol.
3. Touch **Anterior** and touch **OK**.



4. Touch **OK** at the prompt: *"Before continuing with selected exam: insert the anterior imaging spacer between camera and face cup"*.
 - If the next patient exam is for an Anterior protocol leave the Anterior Imaging Spacer on the RetinaVue 700 Imager
 - If the next patient exam is for a Retina protocol, see the instructions for removing the Anterior Imaging Spacer from the RetinaVue 700 Imager



CAUTION Failure to remove the Anterior Imaging Spacer before a Retina exam may result in unacceptable image quality or failure to capture an image.

Perform an Anterior image eye exam



WARNING Clean and disinfect the face cup after each patient to avoid the risk of cross-contamination.



WARNING Patient injury risk. The Anterior Imaging Spacer of the RetinaVue 700 Imager uses magnets to attach to the device and to the face cup. If your patient has any type of cranial implant, it is advisable to reduce direct contact of the Anterior Imaging Spacer or the face cup's magnets with the patient's skin surface containing the implant.



NOTE The Anterior Imaging Spacer is an available accessory for the RetinaVue 700 Imager.

1. From the *Patients* screen, touch on the Patient's name or ID (MRN).



Any scheduled patients appear on the *Patients* screen. (Wireless workflow images shown)

2. Touch **Exam** to open a new exam.

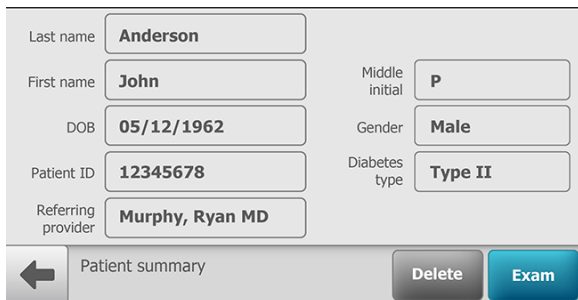

3. From the *Pre Acquisition* screen, touch  (**Settings**) to select the Anterior protocol.

4. Touch **Anterior** and touch **OK**.

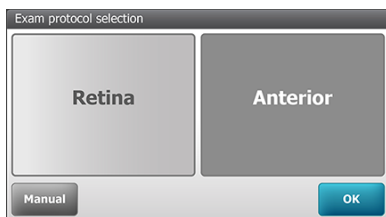

5. Touch **OK** at the prompt: "Before continuing with selected exam: insert the anterior imaging spacer between camera and face cup".
6. From the *Pre Acquisition* screen, touch **START EXAM**.



7. Position the RetinaVue 700 Imager about 4 inches directly in front of the your patient. Keep the RetinaVue 700 Imager **level** and **in line** with your patient's eyes. Brace your arms against your body to help keep the RetinaVue 700 Imager steady.
8. Move the RetinaVue 700 Imager toward the patient and align the yellow circle to the patient's right pupil.
9. Place the face cup firmly on the patient's face. Do not hover near the face with the RetinaVue 700 Imager. Keep the RetinaVue 700 Imager level.

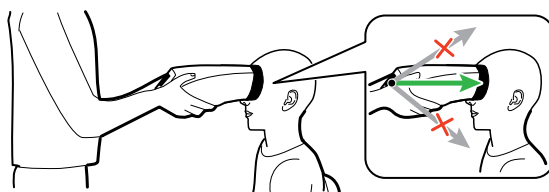

NOTE After placing the face cup firmly on the patient's face, the right pupil should be visible within the screen.

10. Ask the patient "Can you see the **entire plus sign?**".

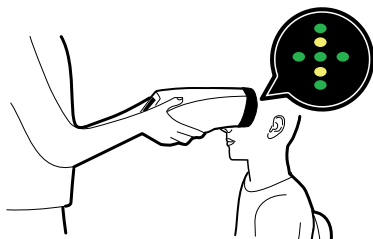

11. Press the face cup **firmly** against the patient's face and then touch **START**.

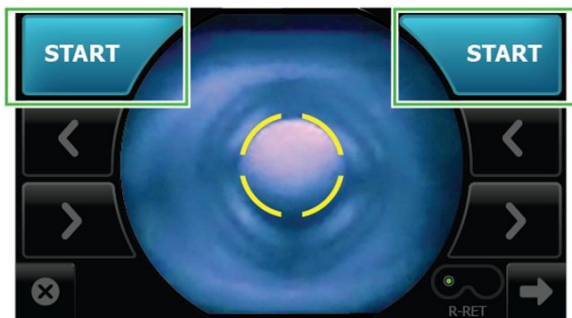

12. Hold steady until the image is captured.



13. If the audio volume is set to an audible level, a camera shutter tone alerts you once the right eye image has been captured.
14. The RetinaVue 700 Imager will automatically move to the left eye and the message: "Lens moving to the next eye." appears. Repeat the steps to align the yellow circle to the pupil and capture an image of the left eye.
15. If the audio volume is set to an audible level, a camera shutter tone alerts you once the left eye image has been captured.



16. Once both images have been captured, the acquired images are available to view on the *Post Acquisition* screen.

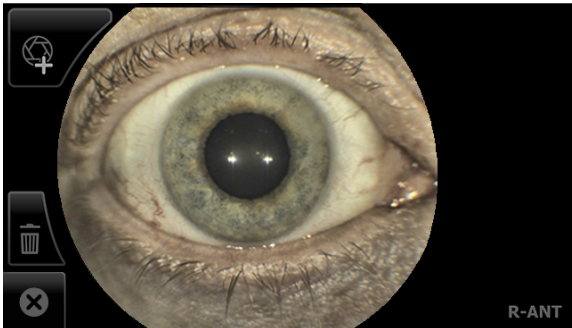

17. Touch  to review the displayed image. The *Inspection mode* screen appears.



- the Anterior image for the right eye contains the **R-ANT** label
- the Anterior image for the left eye contains the **L-ANT** label

If needed, touch  (delete) to dispose of an image and to begin a capture of another image. Touch **OK** at the prompt "Do you want to discard this image?". From the *Post Acquisition* screen, touch  (Add image) to capture an additional image using the existing protocol.

18. Touch  (**Next**) after all images are automatically captured. The *Exam summary* screen appears.
19. From the *Exam summary* screen, follow step a. and step b. below.

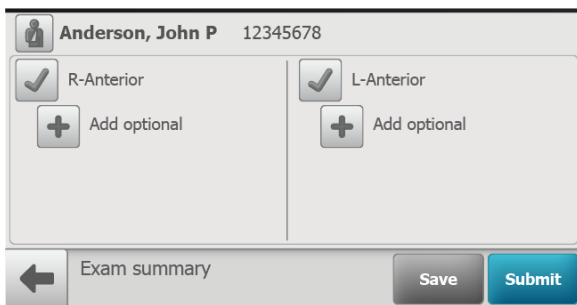



The screenshot shows a patient exam form for Anderson, John P (ID: 12345678). The form is divided into two columns for 'R-Anterior' and 'L-Anterior'. Each column has a checkmark icon, the text 'R-Anterior' or 'L-Anterior', and a plus sign icon with the text 'Add optional'. At the bottom, there is a navigation bar with a back arrow, the text 'Exam summary', a 'Save' button, and a 'Submit' button.



- a. Touch **Save** to save the exam to the device for further review or editing.
- b. Touch **Submit** to submit the exam to the RetinaVue Network Customer Portal.

Enable NTP for automatic date and time

In the wireless workflow, the camera can automatically update and maintain the camera date and time when connected to Wi-Fi. The network time protocol (NTP) setting enables this feature. If the NTP option is enabled, you will not be able to manually adjust the date and time settings. To manually adjust the date and time, disable NTP. Follow the steps below to enable or disable NTP.

1. From the main *Patients* screen on the RetinaVue 700 Imager, touch  (Navigation Menu).
2. Touch **Settings**.
3. Touch **Advanced settings**.
4. Touch **Date & time**.
5. To enable NTP and allow the device to automatically assign the date and time, touch the empty box next to "Enable NTP" so that a check mark appears. To disable NTP so that you can manually adjust the date and time, touch the check mark so that the box is empty.
6. Touch  (back) to return to the main advanced settings screen.

Adjust wait time between image captures

1. From the main *Patients* screen on the RetinaVue 700 Imager, touch  (Navigation Menu).
2. Touch **Settings**.
3. Touch **Advanced settings**.
4. Touch **Recovery time**.
5. If it is not already enabled, touch the toggle switch next to "Enable wait time between image captures" to turn on the recovery-time feature.
6. Select the length of time from the drop-down menu.
7. Touch  (back) to return to the main advanced settings screen.

Wireless certificate support overview for the IT department

The scope of this instruction is to provide information on the support of wireless client certificates, including the wireless client support of server certificate authentication. This instruction does not point to a specific authentication server, nor does it apply a specific mechanism (e.g., OpenSSL, Windows makecert) to create the certificates. This support only pertains to loading a customer's wireless certificates onto the RetinaVue 700 Imager's IEEE802.11 a/b/g/n wireless radio card.

You can install certificates using a computer and a USB cable. The RetinaVue 700 Imager's IEEE802.11 a/b/g/n radio supports files containing a device's client certificate or certificate chain and private key, and files containing a CA certificate or certificate chain. Certificates to be loaded to the device radio must be packaged in the appropriate file format as shown below. You may load only one client certificate file and one CA certificate file at a time. If you attempt to load more than one file of either type, the new file will replace the previous file of that type.

Reset factory default settings



NOTE Resetting all device and radio settings will remove all installed wireless certificates.

Wireless radio security credentials

Purpose	Contents	Format	Filename extension ¹
EAP-TLS client authentication	Client certificate or certificate chain and private key	PKCS#12 or PEM	.p12, .pfx, or .pem
EAP-TLS or PEAP-MSCHAPv2 server validation	CA certificate or certificate chain	DER or PEM	.cer, .der, or .pem

¹ You may use any file name, however, the RetinaVue 700 Imager requires one of the filename extensions in this table to recognize the file.

Loading wireless certificates

1. Touch **RetinaVue Network - Wi-Fi** to select the wireless workflow and touch **Next**.

2. Select the network name from the displayed list, or select 'Other...' to enter the network name. Touch within the *Network name* field to launch the onscreen keyboard. Type your network name and touch **OK**.
3. Choose the WPA2 Enterprise security type and touch **Next**.
4. Touch either EAP-TLS or PEAP-MSCHAPv2 for your appropriate network security type. Check the box for Server certificate validation if you want the RetinaVue 700 Imager to verify the wireless security server's identity. Touch **Next**.
5. If the certificates are already installed touch **Skip** at the prompt: *"Using a USB cable, plug the camera in to a computer to copy Wi-Fi certificate(s) onto the camera. If the certificates are already installed touch Skip."*
6. Prepare the certificates on the computer and plug the USB cable into the computer and into the RetinaVue 700 Imager.
7. Copy the certificates onto the RetinaVue 700 Imager into the folder titled "Certificates" when the following prompt appears: *"Camera is plugged in to a computer. Copy certificate file(s) to the camera's ""Certificates"" directory. When finished copying file(s), unplug the camera from the computer."*

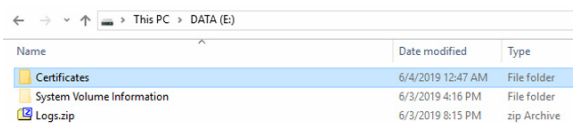

8. Unplug the RetinaVue 700 Imager from the computer.
9. From the "Choose" drop-down menu, select a certificate file to install.
 - If the *"Selected file is not recognized or not a supported type; select another."* message appears, select another file type and try again.
 - For a PKCS#12 certificate file, enter the password.
 - Touch **OK** to install the certificate file for the RetinaVue 700 Imager radio.
10. Touch **OK** at the *"Certificate installed successfully."* prompt. Select another certificate file to install, or touch **Done** if all certificates are installed.

Follow the on-screen instructions to complete the network connection.

Troubleshooting



CAUTION A defective device should not be used. A device with parts which may be broken or missing, visibly worn, distorted, or contaminated should be replaced immediately.

To correct an error, follow these instructions or contact Welch Allyn Technical Support: www.welchallyn.com/service.

Troubleshooting image quality

Good quality image

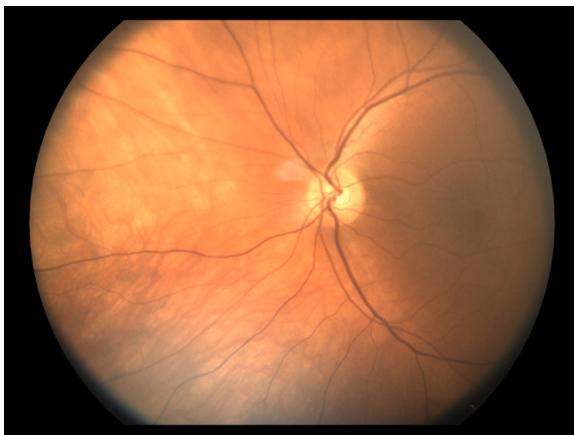

Problem	Solution
Partial blink	Ask the patient to keep his or her eye open.

Problem

Solution

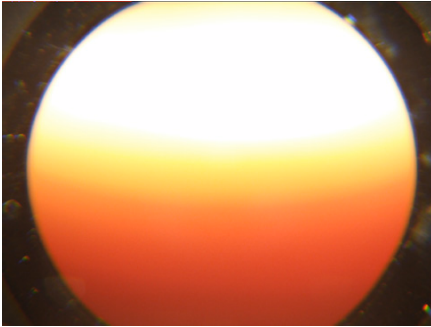

Dirty lens

Clean the lens with a clean micro fiber cloth or a dry, non-abrasive wipe (e.g. Kim Tech wipe).

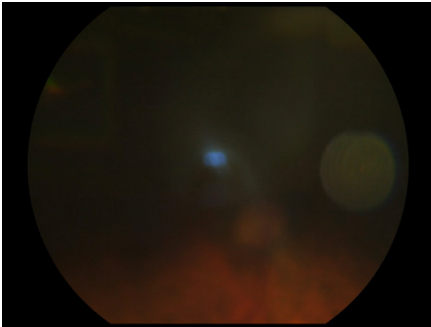

Washed out image

Have the patient slightly tilt their head back during the image capture.

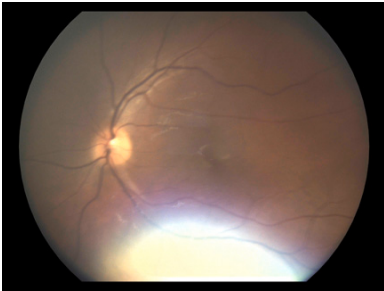

Large pupil (7mm and +)

If the patient's entire pupil will not fit within the yellow circle, the automatic capture mode may not start promptly. Pull the RetinaVue 700 Imager slightly

Problem

Solution

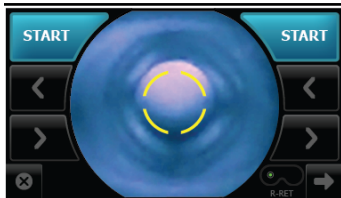

away from the patient and realign the yellow circle to the pupil.

Information messages

Information message/problem

Solution

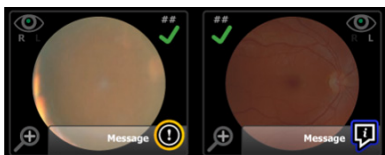

Dirty lens

Clean the camera lens with a non-abrasive wipe.

Clean the camera lens with a clean micro fiber cloth or a dry, non-abrasive wipe (e.g. Kim Tech wipe). Additional cleaning instructions can be found in the topic *Cleaning and Disinfection*.

Small pupil

Have the patient sit in a dark room for 5 minutes to dilate their pupils.

To ensure that the patient's pupils sufficiently dilate, adjust the room lighting to the lowest possible level. If necessary, have the patient sit in a dark room for 5 minutes to dilate their pupils.

Refer to technique guide and try again.

See the *Technique guide* for further detail.

Exam paused - please have the patient remain still and don't move the camera.

Touch **Resume**.

Keep camera steady. See the *Technique guide* for further detail.

Unable to locate patient eye.

Please restart exam or capture from exam summary.

Restart exam.

No image

Restart exam.

To add an image touch  (Add image) to capture an image.

Information message/problem

Solution

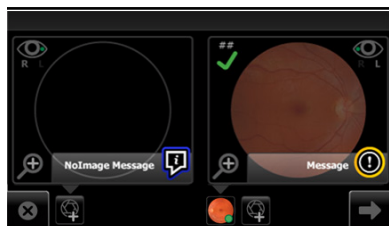

You must capture at least one image before continuing.

Take an image.

Restart exam. See the *Technique guide* for further detail.

To add an image touch  (Add image) to capture an image.

Discard unsaved images and patient data?

Confirm that you want to exit exam without saving the patient images and patient data or touch **No** and resume the exam.

Battery level low. Plug into AC power now.

When the battery charge level is below 10 percent, the low battery error message appears. Connect the camera to the power supply to charge the battery.

Battery level is too low to perform an exam. Plug into AC power now.

Connect the camera to the power supply to charge the battery.

There are unsubmitted exams that need to be sent.

See the *Review* topic for further information about submitting exams.

*Invalid code.
Contact your RetinaVue Network administrator to reset the code.*

Contact your RetinaVue Network administrator to reset the code.

*Invalid code. Device locked.
Try again in 01:57.*

Try again after the time shown has passed. Contact your RetinaVue Network administrator to reset the code.

Contact your RetinaVue Network administrator to reset the code.

*If you forgot your access code, touch **Cancel** and contact your network administrator for the code. If you are a network administrator and need to factory reset, touch **Factory reset** to begin this process, or reset your code at the RetinaVue Network Customer Portal.*

If you are not a network administrator, touch **Cancel** and contact your network administrator. If you do not want to reset your Device access code, touch **Cancel**. If you are a network administrator and would like to reset your Device access

Information message/problem**Solution**

code, touch **Factory reset** or reset your code at the RetinaVue Network Customer Portal.

*If you proceed with the factory reset, the device will delete any exams or patient data saved to the camera and you will lose access to the device until your network administrator reconfigures the camera. Touch **Cancel** if you do not want to proceed with the factory reset.*

If you are not a network administrator, touch **Cancel** and contact your network administrator. If you do not want to reset your Device access code, touch **Cancel**. If you are a network administrator and would like to reset your Device access code, touch **Factory reset** or reset your code at the RetinaVue Network Customer Portal.

*If you proceed with the factory reset, your network administrator will need to reregister your device at the RetinaVue Network Customer Portal. Touch **Cancel** if you do not want to proceed with the factory reset.*

If you are not a network administrator, touch **Cancel** and contact your network administrator. If you do not want to reset your Device access code, touch **Cancel**. If you are a network administrator and would like to reset your Device access code, touch **Factory reset** or reset your code at the RetinaVue Network Customer Portal.

Are you sure you still want to proceed with the factory reset?

If you are not a network administrator, touch **Cancel** and contact your network administrator. If you do not want to reset your Device access code, touch **Cancel**. If you are a network administrator and would like to reset your Device access code, touch **Factory reset** or reset your code at the RetinaVue Network Customer Portal.

The selected exam request associated with this patient has been canceled.

Refresh the patient list.

Error message/problem**Solution**

Temperature warning: CPU is overheating. Power down, reboot, if problem persists contact tech support.

Power down, reboot, if problem persists contact tech support.

Invalid start position. Please restart exam or capture image from exam summary.

Restart exam or capture image from exam summary.

Error message/problem	Solution
<i>Focus motor not responding. Please reboot. Contact tech support if problem continues. Any captured images should be saved or submitted before reboot.</i>	Reboot. Contact tech support if problem continues. Any captured images should be saved or submitted before reboot.
<i>Calibration values missing. The device cannot capture images. Call tech support.</i>	Contact tech support.
<i>Database full. Unable to add a new patient or start a new exam. Reset to factory settings, delete saved exams, or submit exams.</i>	Reset to factory settings, delete saved exams, or submit exams.
<i>Database corrupt. The Patient list and Review screen might display incorrectly. Call tech support.</i>	Contact tech support.
<i>Data export failure. Exam disabled. Reboot or call tech support if the problem persists.</i>	Reboot or call tech support if the problem persists.
<i>Exam export failure. Exam disabled. Reboot or call tech support if the problem persists.</i>	Reboot or call tech support if the problem persists.
<i>A motor did not respond. Save or submit any captured images and then reboot. Contact technical support of the problem continues.</i>	Save or submit any captured exams and then reboot. Contact technical support if the problem continues.

Computer information messages (USB only)

Problem	Solution
The Windows® operating system may display the <i>Scan and fix</i> or <i>Continue without scanning</i> message once the camera USB cable is removed from the laptop or PC.	Select <i>Scan and fix</i> if this Windows message appears in situations when the camera is connected to a laptop or PC by the USB cable.
The Windows® operating system may display the AutoPlay notification prompt each time the camera the USB cable is connected to the laptop or computer.	By default, the AutoPlay notification is displayed when a USB storage device is connected to the laptop or PC. To disable this notification, select Control Panel > AutoPlay from the Windows® Start menu. Uncheck the <i>Use AutoPlay for all media and devices</i> checkbox. Click Save .

Problem

Solution

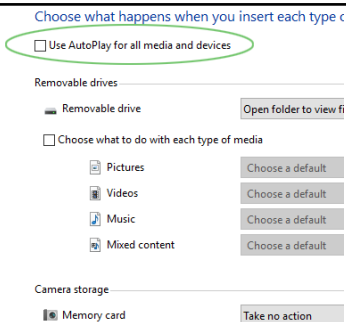

Problem

Solution

Battery is not installed. Camera will not charge. The power indicator LED light on the camera does not light and briefly blinks when the power supply is removed.

Install the battery and check to ensure that the connector pins on the battery and the device are properly seated.

Wireless radio messages

Message

Suggested action

Radio inoperable. Error connecting to the network. Confirm that the network signal strength is sufficient.

See *Wireless connectivity*.

Invalid configuration. Error connecting to the network.

See *Wireless connectivity*.

Error connecting to the network using the supplied credentials.

Re-enter the network name, username and password.

Failed to connect to the RetinaVue Network Portal. Please retry.

Re-enter the network name, username and password.

Unsuccessful wireless radio update

Download the new firmware update and try again.

Download the new firmware update and try again.

Message	Suggested action
<i>Camera connection error, new exams disabled. Reboot or call tech support if the problem persists.</i>	Reboot or call tech support if the problem persists.
Certificate load failed.	
<i>Unable to read the certificate. The password is incorrect.</i>	Re-enter the password.
<i>Certificate installation failed.</i>	Follow the on-screen instructions.
<i>Invalid certificate path.</i>	
<i>Selected file is not recognized or not a supported type; select another.</i>	
Certificate load successful.	No action required.

Wireless connectivity



NOTE See the topic *Technical specifications* for bandwidth requirements.

Problem	Solution
Cannot connect to the network.	Possible invalid username or password.
Connection drops.	Missing wireless certificate. Ensure that the signal strength is sufficient. The signal strength appears in the top right corner of the device status bar.
	 <p>Wireless signal strength</p> <ul style="list-style-type: none"> - Best (4 bars) - Good (3 bars) - Fair (2 bars) - Weak (1 bar)

Problem

Solution

Cannot connect to the RetinaVue Network Server.
 Message: *Error connecting to the network using the supplied credentials.*

Ensure that Wi-Fi is connected.

Touch **Settings**.

Touch **Wi-Fi**.

Ensure that a network name appears. If no name appears, then select a network name again, enter a Username and Password and touch **OK**.

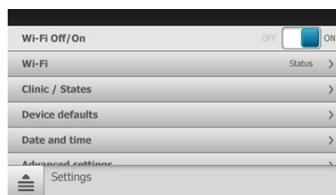

Ensure that IP address is populated and shows a valid IP address other than 00:00:00:00:00:00.

Touch **Settings**.

Touch **Info**. The *Network Information* screen appears.

MAC address 00:17:23:e5:d5:a5
IP address 10.20.200.70
Subnet mask 255.255.255.1
Gateway 10.20.244.1
Version 2.00.02
SSID Your Network
Access Point MAC B2:DE:31:OC:32:B2
RSSI -70

Cannot delete patient from the camera.
 Message: *Failure to connect to the portal. Unable to delete patient information.*

Follow all steps for connecting to RetinaVue Network Server.

Clinic network does not appear in the Wi-Fi list.

Ensure that your network meets the supported credentials type.

Check with your network administrator and ensure the network you are attempting to connect with has one of the following security types:

Problem**Solution**

WPA2-PSK, WPA2 Enterprise, EAP-TLS or PEAP-MSCAPv2 with Server certificate validation.

Follow the on screen instructions to connect a USB cable to the RetinaVue 700 Imager and then copy the Wi-Fi certificate(s) onto the camera.

If certificates are already installed, touch **Skip**.

Hidden SSID networks

Manually enter the network name.

Touch **Settings**.

Touch **Wi-Fi**.

Scroll to the bottom of the list. Touch **Other** and launch the keyboard to enter the network name, followed by password, and then select security type.

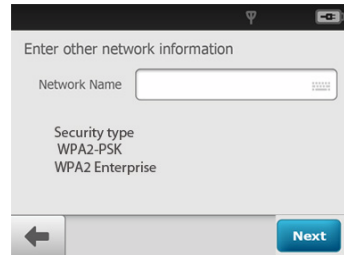

Camera does not connect to the network. Ensure that correct network credentials are used.

For PSK, ensure that the correct Username and Password are entered.

Touch **Settings**. Touch **Wi-Fi**. Select a network name from the list, enter your Username and Password, and check the "Remember this

Problem

Solution

connection" checkbox. Every time you reboot the camera, it will connect to the network automatically. For TLS, ensure that the correct Username is entered.

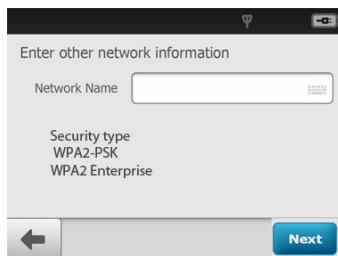

Patient List is empty.

Follow all steps for connecting to RetinaVue Network Server.

Touch  to refresh the scheduled patients list.

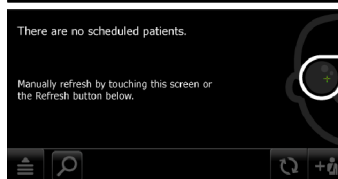



Exam was not sent to the RetinaVue Network Server. Message: *Exam not yet submitted. Exam will be submitted automatically when wireless connection is available.*

Follow all steps for connecting to RetinaVue Network Server.

To view or change the settings, touch  (**Navigation Menu**) from the main *Patients* screen. Touch **Review**.

From the Submitted status, click these icons to see additional status messages:

-  - Waiting to upload,  - Submitted,
-  - Report available



NOTE After an exam has been over-read and downloaded, the exam will be removed from submitted column of the RetinaVue Network Customer Portal and from the camera "Submitted" exams *Review* screen.

Problem**Solution**

Check your network connection. If your saved exam does not appear in the Review list, then it was successfully submitted to the RetinaVue Network Server. Check the "View New Diagnostic Reports" area on the RetinaVue Network Customer Portal. Select your clinic name from the drop-down menu. Find your patient and check the Report column. A "Submitted" status confirms that the exam was successfully received by the RetinaVue Network Server.

Exam Date	Submission Date	Report Date	
5/29/2019	5/29/2019	5/29/2019	View
5/29/2019	5/29/2019	5/29/2019	View

Maintenance

Cleaning and disinfection

To help prevent injury and/or equipment damage, obey these warnings:



WARNING To avoid the risk of cross-contamination, do not reuse wiping materials for multiple steps or on multiple products.



WARNING Cleaning and disinfecting solutions may cause skin rash and/or irritation upon contact. Follow the manufacturer's instructions found on the product label and Safety Data Sheet (SDS).



WARNING Electric shock hazard. Before cleaning and disinfecting any component or accessory, disconnect the AC power cord from the mains outlet and the power source.

To help prevent equipment damage, obey these cautions:



CAUTION Do not use abrasive cleaning agents, thinners, or benzene for cleaning.



CAUTION Do not immerse the RetinaVue 700 Imager in water or other cleaning liquids.



CAUTION Do not use unapproved cleaning and disinfection agents. Use of these agents may cause damage to components.



CAUTION Consult the cleaning and disinfection agent manufacturer instructions for proper use and germicidal efficacy, prior to use.

Hillrom recommends cleaning and disinfecting the face cup before first patient use, in between patient uses, and whenever the face cup is visibly soiled. The remaining areas of the device should be cleaned when soiled and disinfected when contaminated.

The RetinaVue 700 Imager lens may be routinely wiped with a soft micro fiber cloth to help maintain a clear image.

Cleaning and disinfection

Cleaning and disinfection are distinctly different processes. **Cleaning** is the physical removal of visible and non-visible soil and contaminants. **Disinfection** is intended to kill microorganisms.

Approved Cleaners/Disinfectants (summarizes the approved cleaners/disinfectants for use with the associated contact time for disinfection)

CLEANER/DISINFECTANT	RECOMMENDED FOR ROUTINE CLEANING AND DISINFECTING	MAINTAIN WETNESS (DISINFECTION CONTACT TIME)
CaviWipes®	Yes	3 minutes
Sani-Cloth® Plus and Super Sani-Cloth®	Yes	3 minutes

When you perform the detailed cleaning and disinfecting steps, please note the following:

- Ensure the cleaning or disinfecting wipe is not dripping, but is saturated with cleaner/disinfectant solution.
- Always replace the wipe when visibly soiled or contaminated.
- Always replace the wiping cloth between steps (clean and disinfect).
- Always use Personal Protective Equipment (PPE).

Prepare the RetinaVue 700 Imager for cleaning and disinfection

1. Disconnect the AC power cord from the mains outlet and power source.
2. Disconnect the USB cable from the camera.
3. If the RetinaVue 700 Imager is attached to the optional pedestal, remove the RetinaVue 700 Imager from the pedestal.
4. Remove the face cup from the RetinaVue 700 Imager.

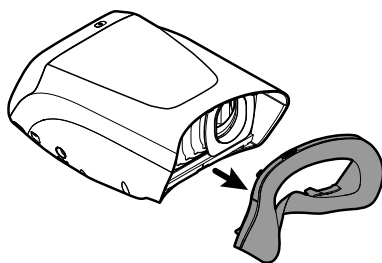

5. If the face cup is attached to the Anterior Imaging Spacer, remove the Anterior Imaging Spacer. The Anterior Imaging Spacer is a separate accessory.

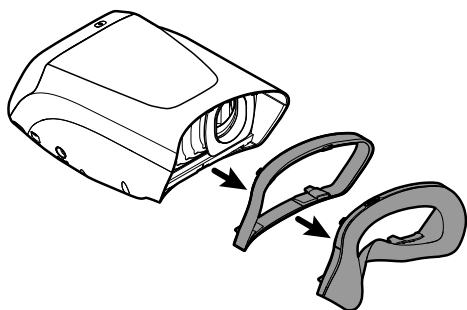

STEP 1. Cleaning

Visible soil:

As necessary, first remove visible soil from the RetinaVue 700 Imager using an approved cleaner/disinfectant wipe. (See the Approved Cleaners/Disinfectants table.)

- Give special attention to any area where soil may accumulate (e.g. fixation bracket, locking screw of the optional pedestal.)
- Use as many wipes as needed to remove the soil.

It is important to remove any visible soil from all the areas before continuing to the non-visible soil.

Non-visible soil:

With a new approved cleaner/disinfectant wipe, use firm pressure to wipe all the surfaces of the RetinaVue 700 Imager. Make sure the following areas are cleaned:

- Face cup
- Anterior Imaging Spacer (optional accessory)
- Imager body
- Touchscreen

- Pedestal (optional accessory)
- Camera barrel*
- Camera lens*
- Dust shield*

*do not apply force while cleaning or wiping the camera barrel, camera lens, dust shield, and touchscreen as this may cause damage.



NOTE Ensure each individual baffle of the dust shield is wiped clean.



NOTE Allow the camera body and dust shield sufficient time to air dry.



NOTE To prevent residue build-up, wipe the camera lens, camera barrel, and touchscreen with a clean micro fiber cloth or a dry, non-abrasive wipe (e.g. Kim Tech wipe).

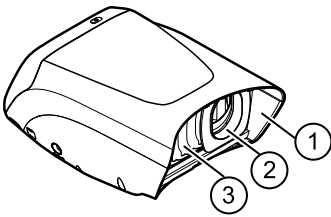

No.	Feature
1	Camera barrel
2	Camera lens
3	Dust shield

STEP 2: Disinfection

1. With a new approved cleaner/disinfectant wipe, use light pressure to wipe all exterior surfaces of the RetinaVue 700 Imager previously cleaned.
2. Make sure all surfaces remain wet with the cleaner/disinfectant for the specified contact time. Re-wet surfaces with a new wiping cloth as necessary. (See the Approved Cleaners/Disinfectants table for contact times.)
3. Allow all surfaces sufficient time to air dry.



NOTE To prevent residue build-up, wipe the camera lens, camera barrel, and touchscreen with a clean micro fiber cloth or a dry, non-abrasive wipe (e.g. Kim Tech wipe).



NOTE Only use the disinfectant process on the lens if a known contamination occurs. Do not routinely use the disinfectant process on the lens or touchscreen as damage may occur over time.

Prepare the RetinaVue 700 Imager for use:

1. Examine the entire RetinaVue 700 Imager for damage.
2. Damaged items should be replaced prior to use.
3. For Anterior imaging, reattach the Anterior Imaging Spacer (separate accessory) to the face cup.
4. Reattach the face cup to the RetinaVue 700 Imager body.

Specifications

Technical specifications



NOTE The recommended network bandwidth is 1 Mbps in a low-latency environment. A network bandwidth of 0.5 Mbps or less may delay or prevent the transmission of images and results.

Field of View	60 degrees \pm 5% horizontal 45 degrees \pm 5% vertical
Pupil Size ¹	2.5 mm and greater
Working distance	19 - 21 mm from objective lens to cornea
Dimensions	Width: 6.6 inches (167 mm) Height: 4.2 inches (106 mm) Length without Anterior Imaging Spacer: 11.4 inches (290.2 mm) Length with Anterior Imaging Spacer: 12 inches (305.4 mm)
	 NOTE The Anterior Imaging Spacer is a separate accessory.
Weight	2.8 pounds (with 2 cell battery, without Anterior Imaging Spacer)
Search Fundus Lighting	Infrared LED
Camera flash light	2 Light Emitting Diodes (LEDs)
Captures	Auto capture and Manual capture Anterior (ANT) image and Retina (RET) image
Camera Resolution	5 megapixels

LCD Monitor	4.3 inch Full Color TFT-LCD	
Image Format	DICOM compliant	
Interface	Micro USB	
File Transfer	Wired	USB to PC by micro USB cable to PC running RetinaVue Network (requires additional software)
	Wireless	WPA2, FIPS certification to Welch Allyn server
File Storage	Integrated storage Ability to save a minimum of 2000 images (500 standard exams, both eyes, using the default protocol) with patient context and camera settings of each image in Integrated storage.	
Power Source	Rechargeable Lithium-ion Battery	
External Power		
Rated input:	Input Spec.: 12V DC, 3A	
Power Adapter Spec.	Input Spec.: 100-240 VAC, 1.0-0.5A, 50-60 Hz	
EDAC POWER ELECTRONICS CO., LTD EM1024PR	Output Spec.: 12V DC, 3A	
Operating Time	Standard capacity battery: 3 hours continuous operation time. High capacity battery: 4 hours continuous operation time. Once set, the device enters Sleep mode if idle for the set time of 2, 5, 7, or 10 minutes. Unless <i>Never</i> is selected, the RetinaVue 700 Imager powers down after 10 minutes of inactivity in Sleep mode.	
Charging Time	5 hours to fully charge via 3A @12V 3 hours to fully charge the empty standard capacity (2-cell) battery via 3A@12V DC adapter in power off. 5 hours to fully charge the empty high capacity (4-cell) battery via 3A@12V DC adapter in power off.	

¹Optical capabilities defined according to the ISO 10940 standard. Image quality will vary with patient physiology, including pupil size.

All specifications are subject to change.

Operating environment

Criterion	Environmental conditions
Temperature	+ 10 °C to + 35 °C
Relative humidity	30 % to 90 %, non-condensing
Atmospheric pressure	800 hPa to 1060 hPa

Storage environment

Criterion	Environmental conditions
Temperature	– 10 °C to + 55 °C
Relative humidity	10 % to 95 %, non-condensing
Atmospheric pressure	700 hPa to 1060 hPa

Transportation environment

Criterion	Transportation conditions
Temperature	– 40 °C to + 70 °C
Relative humidity	10 % to 95 %, non-condensing
Atmospheric pressure	500 hPa to 1060 hPa

Device lifetime

The lifetime of the device is five (5) years. The manufacture date of the device can be found on the device labels.

Welch Allyn will service RetinaVue 700 Imager devices that are within their lifetime. Firmware updates and support may require an annual subscription service after the initial one (1) year warranty period. The expected battery life is at least one (1) year. If the RetinaVue 700 Imager device fails to hold a charge, a new battery can be ordered.

Device radio

The RetinaVue 700 Imager's radio operates on 802.11 networks.

Feature	Description
Regulatory Domain Support	FCC (Americas, Parts of Asia, and Middle East)
2.4 GHz Frequency Bands	FCC: 2.4 GHz to 2.483 GHz
2.4 GHz Operating Channels	FCC: 11 (3 non-overlapping)
5 GHz Frequency Bands	FCC: 5.15 GHz to 5.35 GHz 5.47 GHz to 5.725 GHz 5.725 GHz to 5.825 GHz
5 GHz Operating Channels	FCC: 24 non-overlapping
WLAN standard	IEEE802.11a/b/g/n, Wi-Fi compliant
Data Rate	802.11a: 54, 48, 36, 24, 18, 12, 9, 6 Mbps OFDM 802.11b: 11, 5.5, 2, 1 Mbps DSSS 802.11g: 54, 48, 36, 24, 18, 12, 9, 6 Mbps OFDM 802.11n: HT20 MCS0~7, OFDM
Modulation	BPSK @ 1, 6, 6.5, 7.2 and 9 Mbps QPSK @ 2, 12, 13, 14.4, 18, 19.5 and 21.7 Mbps CCK @ 5.5 and 11 Mbps 16-QAM @ 24, 26, 28.9, 36, 39 and 43.3 Mbps 64-QAM @ 48, 52, 54, 57.8, 58.5, 65, and 72.2 Mbps

Feature	Description
Host interface	USB 2.0
Encryption	Wireless Equivalent Privacy (WEP), Wi-Fi Protected Access (WPA), IEEE 802.11i (WPA2)
Antenna	PCB Dipole, IPEX MHF, Max Gain: 2.4-2.5 GHz: 2 dBi 5.15-5.35 GHz: 3.9 dBi 5.6 GHz: 4 dBi
Agency approvals	US: FCC Part15 Subpart B, Part 15.247 Subpart C, Part 15.407 Subpart E (DFS)

General compliance and standards

The RetinaVue 700 Imager complies with the following standards:

IEC 60601-1:2005/A1:2012

IEC 60601-1-2 : 2014

ISO 15004-1 : 2006

ISO 15004-2 : 2007

ISO 10940 : 2009

ISO 10993-1 : 2009

ISO 14971 : 2019

IEC 62304 : 2006+A1 : 2015

IEC 62366-1 : 2015

IEC 60601-1-6 : 2010+A1

Storage and disposal

Disposal must be in accordance with the following steps:

1. Follow the instructions in this manual in the section *Cleaning and disinfection*.
2. Delete all existing data related to patients/hospital/clinic/doctor. Data backup may be performed prior to deletion.
3. Segregate material in preparation for the recycling process:

- Components are to be disassembled and recycled based on type of material:
 - Plastic to be recycled as plastic waste
 - Metal to be recycled as metals
 - Includes loose components containing more than 90% metal by weight
 - Includes screws and fasteners
 - Electronic components, including the power cord, to be disassembled and recycled as Waste of Electrical and Electronic Equipment (WEEE)
 - Batteries to be dismantled from the device and recycled as per WEEE

Users must adhere to all federal, state, regional, and/or local laws and regulations as it pertains to the safe disposal of medical devices and accessories. If in doubt, the user of the device shall first contact Hillrom Technical Support for guidance on safe disposal protocols.

For more specific disposal or compliance information, see www.welchallyn.com/weee, or contact Hillrom Technical Support: hillrom.com/en-us/about-us/locations/.



Residual risk

This product complies with relevant electro-magnetic interference, mechanical safety, performance, and biocompatibility standards. However, the product cannot completely eliminate potential patient or user harm from the following:

- Harm or device damage associated with electro-magnetic hazards,
- Harm from mechanical hazards,
- Harm from device, function, or parameter unavailability,
- Harm from misuse error, such as inadequate cleaning, and/or
- Harm from device exposure to biological triggers that may result in a severe systemic allergic reaction.

General radio compliance

The wireless features of this device must be used in strict accordance with the manufacturer's instructions as described in the user documentation that comes with the product.

Federal Communication Commission Interference Statement

This equipment has been tested and found to comply with the limits for a Class B digital device, pursuant to Part 15 of the FCC Rules. These limits are designed to provide reasonable protection against harmful interference in a residential installation. This equipment generates, uses and can radiate radio frequency energy and, if not installed and used in accordance with the instructions, may cause harmful interference to radio communications. However, there is no guarantee that interference will not occur in a particular installation. If this equipment does cause harmful interference to radio or television reception, which can be determined by turning the equipment off and on, the user is encouraged to try to correct the interference by one of the following measures:

- Reorient or relocate the receiving antenna.
- Increase the separation between the equipment and receiver.
- Connect the equipment into an outlet on a circuit different from that to which the receiver is connected.
- Consult the dealer or an experienced radio/TV technician for help.

FCC Caution: Any changes or modifications not expressly approved by the party responsible for compliance could void the user's authority to operate this equipment.

Operation is subject to the following two conditions: (1) This device may not cause harmful interference, and (2) this device must accept any interference received, including interference that may cause undesired operation.

This transmitter must not be co-located or operating in conjunction with any other antenna or transmitter. This device meets all the other requirements specified in Part 15E, Section 15.407 of the FCC Rules.

EMC compliance

Special precautions concerning electromagnetic compatibility (EMC) must be taken for all medical electrical equipment. This device complies with IEC 60601-1-2 : 2014 (EN 60601-1-2 : 2015).

- All medical electrical equipment must be installed and put into service in accordance with the EMC information provided in this *Instructions for use*.
- Portable and mobile RF communications equipment can affect the behavior of medical electrical equipment.

The device complies with all applicable and required standards for electromagnetic interference.

- It does not normally affect nearby equipment and devices.

- It is not normally affected by nearby equipment and devices.
- However, it is good practice to avoid using the device in extremely close proximity to other equipment.
- It is not safe to operate the device in the presence of high-frequency surgical equipment.



WARNING The use of the device adjacent to or stacked with other equipment or medical electrical systems should be avoided because it could result in improper operation. If such use is necessary, the device and other equipment should be observed to verify that they are operating normally.



WARNING Use only Accessories recommended by Welch Allyn for use with the device. Accessories not recommend by Welch Allyn may affect the EMC emissions or immunity.



WARNING Maintain minimum separation distance between the device and portable RF communication equipment. Performance of the device may be degraded if proper distance is not maintained.

Emissions and immunity information

Electromagnetic emissions

The device is intended for use in the electromagnetic environment specified below. The customer or user of the device should assure that it is used in such an environment.

Emissions test	Compliance	Electromagnetic environment - guidance
RF emissions CISPR 11	Group 1	The device uses RF energy only for its internal function. Therefore, its RF emissions are very low and are not likely to cause any interference in nearby electronic equipment.
RF emissions CISPR 11	Class B	The device is suitable for use in all establishments, including domestic establishments and those directly connected to the public low voltage power supply network that supplies buildings used for domestic purposes.
Harmonic emissions IEC 61000-3-2	Class A	
Voltage fluctuations/ flicker emissions IEC 61000-3-3	Complies	 WARNING This equipment/system is intended for use by healthcare professionals only. This equipment/ system may cause radio interference or may disrupt the operation of nearby equipment ^a . It may be necessary to take mitigation measures, such as re-orienting or relocating the device or shielding the location.

Electromagnetic emissions

^a The device contains a 5-GHz orthogonal frequency-division multiplexing transmitter or a 2.4-GHz frequency hopping spread-spectrum transmitter for the purpose of wireless communication. The radio is operated according to the requirements of various agencies, including FCC 47 CFR 15.247. The transmitter is excluded from the EMC requirements of 60601-1-2, but should be considered when addressing possible interference issues between this and other devices.

Electromagnetic immunity

The device is intended for use in the electromagnetic environment specified below. The customer or the user of the device should assure that it is used in such an environment.

Immunity test	IEC 60601 test level	Compliance level	Electromagnetic environment - guidance
Electrostatic discharge (ESD) IEC 61000-4-2	±8 kV contact ±15 kV air	±8 kV ±15 kV	Floors should be wood, concrete or ceramic tile. If floors are covered with synthetic material, the relative humidity should be at least 30%.
Electrical fast transient/burst IEC 61000-4-4	±2 kV for power supply lines ±1 kV for input/output lines	±2 kV ±1 kV	Mains power quality should be that of a typical professional healthcare facility environment.
Surge IEC 61000-4-5	±0.5 kV, ±1 kV Line- to -line ±0.5 kV, ±1 kV, ±2 kV Line-to-ground	±1 kV ±2 kV	Mains power quality should be that of a typical professional healthcare facility environment.
Voltage dips, short interruptions and voltage variations on power supply input lines IEC 61000-4-11	0 % U _T ; 0.5 cycle At 0°, 45°, 90°, 135°, 180°, 225°, 270° and 315° 0 % U _T ; 1 cycle 70 % U _T ; 25/30 cycles Single phase: at 0° 0 % U _T ; 250/300 cycle	0 % U _T ; 0.5 cycle 0 % U _T ; 1 cycle 70 % U _T ; 25/30 cycles 0 % U _T ; 250/300 cycle	Mains power quality should be that of a typical professional healthcare facility environment. If the user of the device requires continued operation during power mains interruptions, it is recommended that the device be powered from an uninterruptible power supply or a battery.

Electromagnetic immunity

Power frequency (50-60 Hz) magnetic field IEC 61000-4-8	30 A/m	30 A/m	Power frequency magnetic fields should be at levels characteristic of a typical location in a typical professional healthcare facility environment.
---	--------	--------	---

Note: U_T is the a.c. mains voltage prior to application of the test level.

Electromagnetic immunity

The device is intended for use in the electromagnetic environment specified below. The customer or the user of the device should assure that it is used in such an environment.

Immunity test	IEC 60601 test level	Compliance level	Electromagnetic environment - guidance
			Portable and mobile RF communications equipment should be used no closer to any part of the device, including cables, than the recommended separation distance calculated from the equation applicable to the frequency of the transmitter.

Recommended separation distance

Conducted RF IEC 61000-4-6	3 Vrms 150 kHz to 80 MHz	3 Vrms	$d = \left[\frac{3.5}{V_1} \right] \sqrt{P}$
	6Vrms in ISM and amateur radio bands between 150 kHz and 80 MHz.	6Vrms .	$d = \left[\frac{12}{V_2} \right] \sqrt{P}$

Radiated RF IEC 61000-4-3	10 V/M, 80 MHz to 2.7 GHz	10 V/M	$d = \left[\frac{23}{E_1} \right] \sqrt{P}$ 800 MHz to 2.7 GHz $d = \left[\frac{12}{E_1} \right] \sqrt{P}$ 80 MHz to 800 MHz where <i>P</i> is the maximum output power rating of the transmitter in watts (W) and <i>d</i> is the recommended separation distance in meters (m). Field strengths from fixed RF transmitters, as determined by an electromagnetic site survey ^a , should be less than the compliance level in each frequency range ^b . Interference may occur in the vicinity of equipment marked with the following symbol:
---------------------------	---------------------------	--------	--



Note1: At 80 MHz and 800 MHz, the higher frequency range applies.

Note 2: These guidelines may not apply in all situations. Electromagnetic propagation is affected by absorption and reflection from structures, objects, and people.

^aField strengths from fixed transmitters, such as base stations for radio (cellular/cordless) telephones and land mobile radios, amateur radio, AM and FM radio broadcast, and TV broadcast

Electromagnetic immunity

cannot be predicted theoretically with accuracy. To assess the electromagnetic environment due to fixed RF transmitters, an electromagnetic site survey should be considered. If the measured field strength in the location in which the device is used exceeds the applicable RF compliance level above, the device should be observed to verify normal operation. If abnormal performance is observed, additional measures may be necessary, such as reorienting or relocating the device.

^bOver the frequency range 150 kHz to 80 MHz, field strengths should be less than 3 V/m.

Recommended separation distances between portable and mobile RF communications equipment and the device

The device is intended for use in an electromagnetic environment in which radiated RF disturbances are controlled. The customer or user of the device can help prevent electromagnetic interference by maintaining a minimum distance between portable and mobile RF communications equipment (transmitters) and the device as recommended below, according to the maximum output power of the communications equipment.

Separation distance according to frequency of transmitter (m)				
Rated max. output power of transmitter (W)	150 kHz to 80 MHz outside ISM bands	150 kHz to 80 MHz in ISM bands	80 MHz to 800 MHz	800 MHz to 2.7 GHz
	$d = \left[\frac{3.5}{V_1}\right]\sqrt{P}$	$d = \left[\frac{12}{V_2}\right]\sqrt{P}$	$d = \left[\frac{12}{E_1}\right]\sqrt{P}$	$d = \left[\frac{23}{E_1}\right]\sqrt{P}$
0.01	0.12	0.20	0.12	0.23
0.1	0.37	0.63	0.38	0.73
1	1.17	2.00	1.20	2.30
10	3.69	6.32	3.79	7.27
100	11.67	20.00	12.00	23.00

For transmitters rated at a maximum output power not listed above, the recommended separation distance d in meters (m) can be estimated using the equation applicable to the frequency of the transmitter, where P is the maximum output power rating of the transmitter in watts (W) according to the transmitter manufacturer.

Note 1: At 80 MHz and 800 MHz, the separation distance for the higher frequency range applies.

Note 2: These guidelines may not apply in all situations. Electromagnetic propagation is affected by absorption and reflection from structures, objects, and people.

Test specifications for enclosure port immunity to RF wireless communications equipment

Test frequency (MHz)	Band ^a (MHz)	Service ^a	Modulation ^b	Maximum power (W)	Distance (m)	Immunity test level (V/m)
385	380 - 390	TETRA 400	Pulse modulation ^b 18 Hz	1.8	0.3	27
450	430 - 470	GMRS 460, FRS 460	FM ^c ±5 kHz deviation 1 kHz sine	2	0.3	28
710	704 - 787	LTE band 13, 17	Pulse modulation ^b 217 Hz	0.2	0.3	9
745						
780						
810	800 - 960	GSM 800/900, TETRA 800, iDEN 820, CDMA 850, LTE Band 5	Pulse modulation ^b 18 Hz	2	0.3	28
870						
930						
1720	1700 - 1990	GSM 1800; CDMA 1900; GSM 1900; DECT; LTE Band 1, 3, 4, 25; UMTS	Pulse modulation ^b 217 Hz	2	0.3	28
1845						
1970						
2450	2400 - 2570	Bluetooth, WLAN, 802.11 b/g/n, RFID 2450, LTE Band 7	Pulse modulation ^b 217 Hz	2	0.3	28
5240	5100 - 5800	WLAN 802.11 a/n	Pulse modulation ^b 217 Hz	0.2	0.3	9
5500						
5785						

^aFor some services, only the uplink frequencies are included.

^bThe carrier shall be modulated using a 50 percent duty cycle square wave signal.

^c As an alternative to FM modulation, 50 percent pulse modulation at 18 Hz may be used because while it does not represent actual modulation, it would be worst case.

Test specifications for enclosure port immunity to RF wireless communications equipment



WARNING Portable RF communications equipment (including peripherals such as antenna cables and external antennas) should be used no closer than 30 cm (12 inches) to any part of the device, including cables specified by the manufacturer. Otherwise, degradation of the performance of this equipment could result.

The minimum separation distance for higher immunity test levels shall be calculated using the following equation:

$$E = \frac{6}{d} \sqrt{P}$$

where P is the maximum power in watts (W), d is the minimum separation distance in meters (m), and E is the immunity test level in V/m .

RetinaVue 700 Imager accessories

Pedestal base

Part number	Description
728134	Welch Allyn Pedestal base for RetinaVue 700 Imager

Miscellaneous items

Part number	Description
RV700-B	RetinaVue 700 Imager with lithium-ion battery and US plug
RV700-6	RetinaVue 700 Imager with lithium-ion battery and Australian plug
106145	RetinaVue 700 Imager neck strap
106146	RetinaVue 700 Imager wrist strap
728131	Welch Allyn 7.2 V Lithium-Ion Battery for RetinaVue 700 Imager, 3200 mAh (Standard Capacity) 33.0143250001
728132	Welch Allyn 7.2 V Lithium-Ion Battery for RetinaVue 700 Imager, 6400 mAh (High Capacity) 33.0146500401
728133	Welch Allyn Battery Charger for RetinaVue 700 Imager
728099	Welch Allyn Power Supply Set for RetinaVue 700 Imager; 100-240 V, 50-60 Hz AC, IEC Plug Type-B, -C, -G, and -I

Part number	Description
728136	Welch Allyn Power Plug Set for RetinaVue 700 Imager; IEC Plug Type-B, -C, -G, and -I
728150	Welch Allyn USB Cable for RetinaVue 700 Imager
728139	RetinaVue 700 Battery cover
723481	Laptop for RetinaVue Network
723671	Lens cloth
729097	Welch Allyn Face Cup Spacer for RetinaVue 700 Imager (also referred to in this document as the Anterior Imaging Spacer)

Applied parts

Part number	Description
728135	Welch Allyn Face Cup for RetinaVue 700 Imager

Service

Part number	Description
S1-RV700-1	Welch Allyn Partners in Care Comprehensive Partnership Program Service for RetinaVue 700 Imager; 1 year
S1-RV700-2	Welch Allyn Partners in Care Comprehensive Partnership Program Service for RetinaVue 700 Imager; 2 years
S1-RV700-3	Welch Allyn Partners in Care Comprehensive Partnership Program Service for RetinaVue 700 Imager; 3 years
S1-RV700-5	Welch Allyn Partners in Care Comprehensive Partnership Program Service for RetinaVue 700 Imager; 5 years
S1-RV700-1P	Welch Allyn Partners in Care Comprehensive Partnership Program Premium Service for RetinaVue 700 Imager; 1 year
S1-RV700-2P	Welch Allyn Partners in Care Comprehensive Partnership Program Premium Service for RetinaVue 700 Imager; 2 years
S1-RV700-3P	Welch Allyn Partners in Care Comprehensive Partnership Program Premium Service for RetinaVue 700 Imager; 3 years
S1-RV700-5P	Welch Allyn Partners in Care Comprehensive Partnership Program Premium Service for RetinaVue 700 Imager; 5 years

Literature and documentation

Part number	Description
728140	RetinaVue 700 Imager Startup guide
728141	RetinaVue 700 Imager Technique guide
729298	RetinaVue 700 Imager Pedestal stand assembly instructions

Hard storage case

Part number	Description
728236	Welch Allyn Premium Hard Storage Case for RetinaVue 700 Imager, Shoulder Strap

Warranty

Welch Allyn warrants the product to be free of defects in material and workmanship and to perform in accordance with manufacturer's specifications for the period of one year from the date of purchase from Welch Allyn or its authorized distributors or agents.

The warranty period shall start on the date of purchase. The date of purchase is: 1) the invoiced ship date if the device was purchased directly from Welch Allyn, 2) the date specified during product registration, 3) the date of purchase of the product from a Welch Allyn authorized distributor as documented from a receipt from said distributor.

This warranty does not cover damage caused by: 1) handling during shipping, 2) use or maintenance contrary to labeled instructions, 3) alteration or repair by anyone not authorized by Welch Allyn, and 4) accidents.

Shipping cost to return a device to a Welch Allyn Service center is not included.

A service notification number must be obtained from Welch Allyn prior to returning any products or accessories to Welch Allyn's designated service centers for repair. To obtain a service notification number, contact Welch Allyn Technical Support.

THIS WARRANTY IS IN LIEU OF ALL OTHER WARRANTIES, EXPRESS OR IMPLIED, INCLUDING BUT NOT LIMITED TO THE IMPLIED WARRANTIES OF MERCHANTABILITY AND FITNESS FOR A PARTICULAR PURPOSE. WELCH ALLYN'S OBLIGATION UNDER THIS WARRANTY IS LIMITED TO REPAIR OR REPLACEMENT OF PRODUCTS CONTAINING A DEFECT. WELCH ALLYN IS NOT RESPONSIBLE FOR ANY INDIRECT OR CONSEQUENTIAL DAMAGES RESULTING FROM A PRODUCT DEFECT COVERED BY THE WARRANTY.



Hillrom.

Material No.
775673



(91)775673