

Baxter

Hillrom
Progressa
ICU HOSPITAL BED

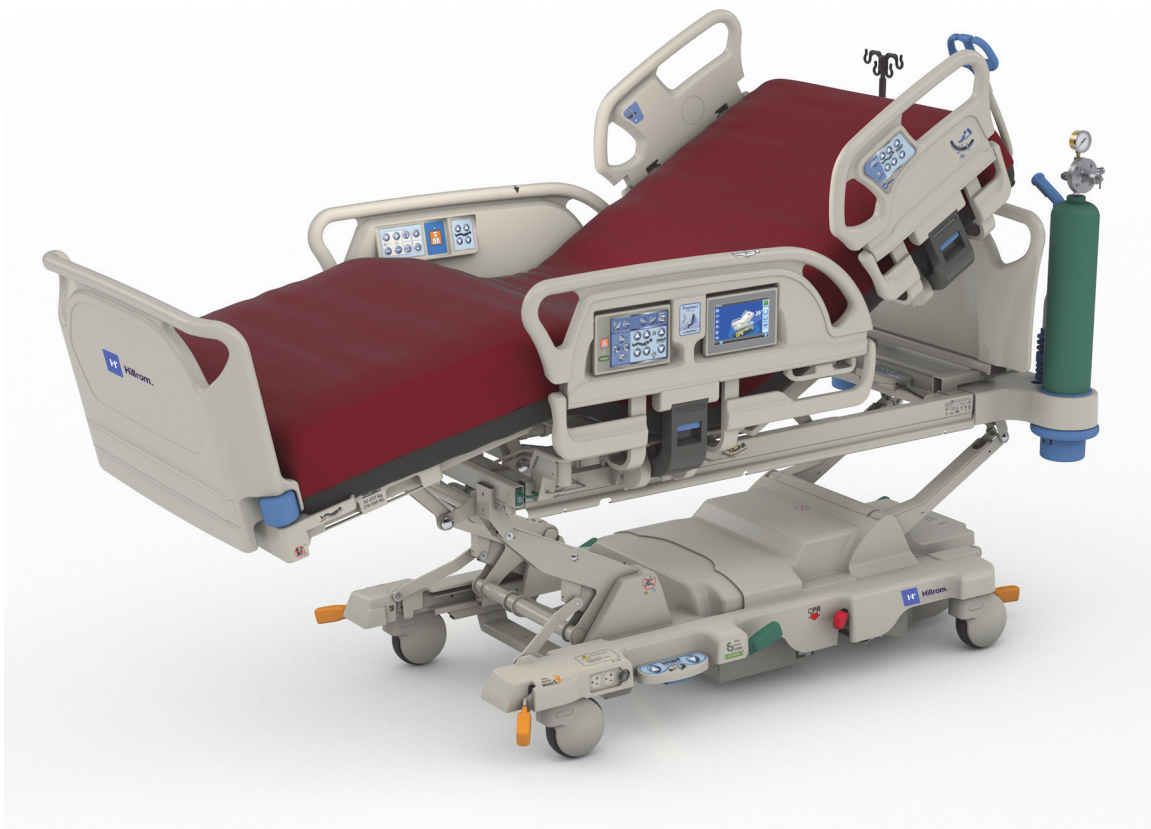

Instructions for Use
Product No. P7500
171528 REV 14

QUICK VIEW LIST OF FEATURES

For more information about a feature, go to the page number shown in the table below.

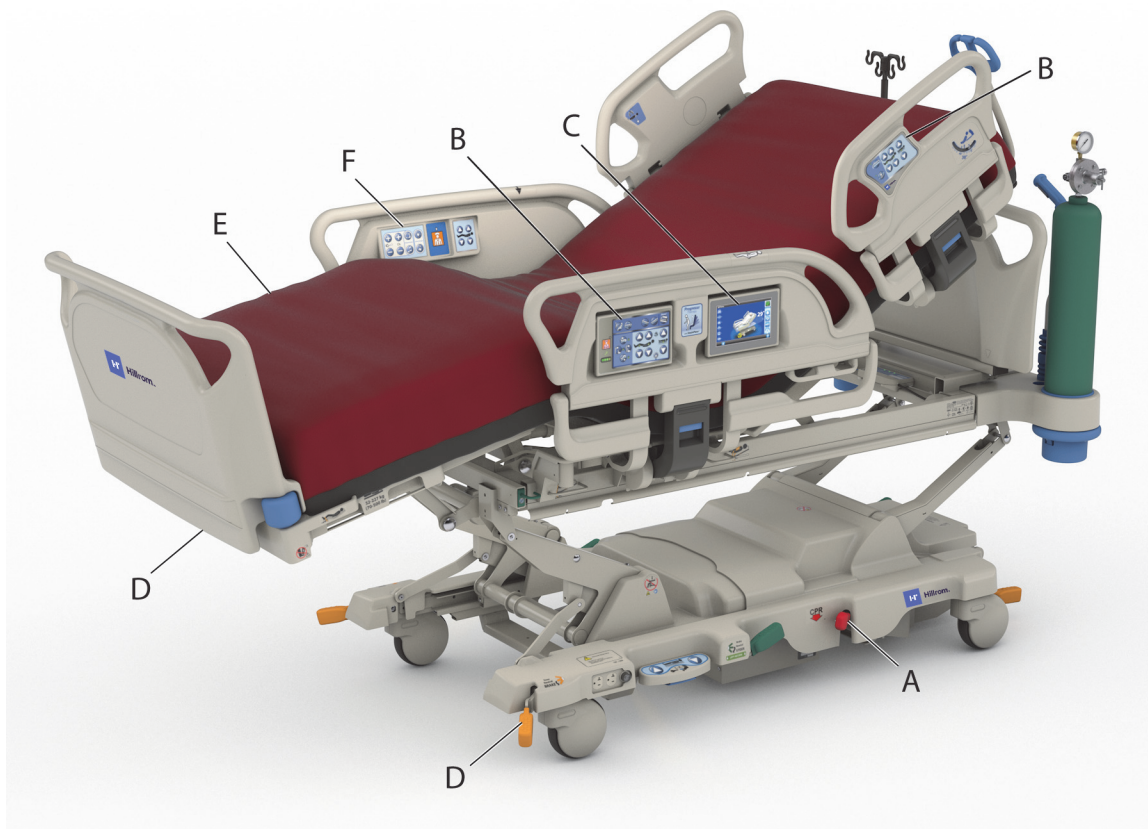

Item	Feature	Page
A	CPR Controls	10
B	Caregiver Siderail Controls —Bed Articulation Controls	13
C	Graphical Caregiver Interface (GCI) Controls —Scale, Alarms, Therapies	26
D	Bed Frame Features —Headboard, Footboard, Brakes, IV Poles, Equipment Sockets, Line Manager, Drainage Bag Holders, Patient Restraints, Fluoroscopy, Accessory AC Outlet, IntelliDrive Transport System	48
E	Surfaces —Mattress Types, Rotation Therapy, Percussion/Vibration Therapy, Opti-Rest, Turn Assist	71
F	Patient Controls —Bed Articulation Controls, Entertainment Controls, Nurse Call Control	83

NOTES:

PATENTS / PATENT hillrom.com/patents

May be covered by one or more patents. See the above Internet address.

The Hill-Rom companies are the proprietors of European, US, and other patents and pending patent applications.

FOSS

This product may contain software known as “free” or “open source” software (FOSS). Hill-Rom uses and supports the use of FOSS. We believe that FOSS makes our products more robust and secure, and gives us and our customers greater flexibility. To learn more about FOSS that may be used in this product, please visit our FOSS website at hillrom.com/opensource. Where required, a copy of FOSS source code is available on our FOSS website.

Legal Manufacturer:

HILL-ROM, INC.
1069 STATE ROUTE 46 E
BATESVILLE, IN 47006-9167
UNITED STATES

**Authorized European Union Representative
and EU Importer:**

HILL-ROM SAS
B.P. 14 - Z.I. DU TALHOUE
56330 PLUVIGNER
FRANCE
TEL: +33 (0)2 97 50 92 12

Authorized Brazilian Representative:

VR MEDICAL - MEDICAL DEVICES IMPORTER &
DISTRIBUTOR, LTDA.
391 BATATAES STREET
CJ 11-13, 8TH FLOOR
SÃO PAULO – SP – BRAZIL
CNPJ: 04.718.143/0001-94

Authorized Australian Sponsor:

HILL-ROM PTY LTD
1 BAXTER DRIVE
OLD TOONGABBIE NSW 2146
AUSTRALIA

Authorized Representative for Kazakhstan:

TOO ORTHODOX PHARM
ULY DALA AVENUE 7/4, APT 136, NUR-SULTAN 010000, KAZAKHSTAN

No part of this text shall be reproduced or transmitted in any form or by any means, electronic or mechanical, including photocopying, recording, or by any information or retrieval system without written permission from Hill-Rom Services, Inc. (Hill-Rom).

The information in this manual is confidential and may not be disclosed to third parties without the prior written consent of Hill-Rom.

The information contained in this manual is subject to change without notice. Hill-Rom makes no commitment to update or keep current, the information contained in this manual.

Hill-Rom reserves the right to make changes without notice in design, specifications, and models. The only warranty Hill-Rom makes is the express written warranty extended on the sale or rental of its products.

Notice to Users and/or Patients in EU—Any serious incident that has occurred in relation to this device, should be reported to the manufacturer and the competent authority of the Member State in which the user and/or patient is established.

This manual (171528) was originally released and supplied in English. For a list of available translations, contact Hillrom Technical Support.

Product images and labels are for illustrative purposes only. Actual product and label may vary.

Fourteenth Edition, 2023-06

First Printing 2013

Baxter, Accella, Accumax, Allen, Boost, Dining Chair, Envision, Experience Pod, FlexAfoot, FullChair, Graphical Caregiver Interface (GCI), HandsFree, Hillrom, IntelliDrive, Line-of-Site, MCM, Obstacle Detect, Point-of-Care, Progressa, SlideGuard, SideCom, and Voalte are trademarks of Baxter International Inc. or its subsidiaries.

Any other trademarks, product names or brand images appearing herein are the property of their respective owners.

Replace this manual (171528) if it is damaged and/or can not be read.

For product support or to order additional copies of this manual (171528), contact your distributor, local Hill-Rom representative, or go to hillrom.com

For training on the use of this product, contact your distributor or local Hill-Rom representative.

Reference Documents

Progressa and Progressa+ Bed Service Manual (171748)

Progressa Bed—Unpacking Instructions (180421)

Table of Contents

Quick View List of Features	i
Intended Use	1
Introduction	1
Symbols	2
Document Symbols	2
Product Symbols	3
CPR Control	10
Use the CPR Control	10
Alerts and Information Indicators	11
Audible Indicators	11
Bed Battery Power	11
Service Required	12
Hip Position Locator	12
Line-of-Site Head Angle Indicator	12
Brake Not Set Alert	12
Caregiver Siderail Controls	13
Raise and Lower the Siderails	13
Siderail Controls Location	14
Lockout Controls	14
Bed Up/Down	15
Head Up/Down	16
StayInPlace Feature	16
Knee Up/Down	16
Foot Elevate [Foot Up/Down]	17
Foot Down	17
Foot Up	17
Lower Leg Elevation [Vascular Position]	17
FlexAfoot Feature [Foot Extend/Retract]	18
Trendelenburg or Reverse Trendelenburg	18
Boost Position System	19
Chair Positions	19
Dining Chair Position	20

FullChair Position.....	20
Chair Egress.....	21
Bed Flat Control.....	22
Sidecom Communication System.....	23
Nurse Call.....	23
Max-Inflate/P-Max Inflate [Siderail Method].....	24
Side Exit Assist.....	24
Caregiver Pendant Controls.....	24
Graphical Caregiver Interface (GCI)	26
Home Screen Description.....	27
Help [?] Menu.....	28
Bed Exit Alert.....	29
Turn ON the Alert.....	29
Turn OFF the Alert.....	30
Pre-Emptive Alert Silence.....	30
To Silence a Bed Exit Alert.....	30
Change the Alert Volume.....	31
Change the Alert Tone.....	31
Head Angle Alert.....	32
Scale.....	33
Scale specifications.....	33
Recommended Bed Position to Weigh a Patient and Required Bed Position to Zero the Bed.....	33
Zero/New Patient.....	34
Weigh the Patient.....	35
Body Mass Index (BMI) Calculator.....	36
View Weight History.....	38
Scale—NAWI Compliant [EN 45501].....	39
Unstable Equilibrium.....	39
Bed not Recommended Position.....	40
Recommended Bed Position to Weigh a Patient and Required Bed Position to Zero/Tare the Bed.....	40
View Weight History.....	40
Zero/Tare the Scale or New Patient.....	41
Magnification Mode [Extended Weighing Device].....	42

Save Weight	43
Add/Remove Items	43
Scale Specifications	44
Settings/Preferences	45
New Patient	45
History	45
Change the Language	45
Adjust Time and Date	46
Version	46
Software Update	46
WiFi On/Off	47
Bed Frame Features	48
Point-of-Care Brake and Steer System	48
Headboard	50
Footboard	50
Transport	51
Transport Handles	51
Transport Position	51
IntelliDrive Transport System [Power Transport]	54
WallGuard Bumper System	56
Line Manager [P7512]	56
Drainage Bag Holders	57
Restraints	58
Fluoroscopy/C-Arm	59
X-Ray Sleeve	60
Equipment Sockets	61
IV Pole Sockets	62
Fracture Frame Sockets	62
Permanent IV Pole Option	63
Auxiliary AC Receptacle Option	64
COMposer Communication System	64
Voalte Nurse Call System	64
Wireless Connectivity	65
External Wireless Module	66
Location Asset Tag	69

Internal Wireless Module	69
SmartCare Remote Management	69
Obstacle Detect System	70
Bed Up/Down—Foot Controls	70
Night Light	71
Equipotential Ground	71
Surfaces	71
Progressa Prevention/Essential Surface	72
Progressa Therapy Surface	72
Modes	72
Progressa Pulmonary Surface	77
Rotation	77
Percussion and Vibration	80
Opti-Rest	82
Patient History	82
Patient Controls	83
Location	83
Nurse Call	83
Head Up/Down Control	83
Knee Up/Down Control	84
Room Light	84
Reading Light	84
Television	84
Radio	84
Television Channel Up/Down Control	85
Volume Control	85
Accessories	85
Infusion Support System [P158A]	86
Removable IV Pole [P7510A]	86
Removable Telescopic IV Pole [P2217A]	87
Permanent IV Pole [P7511A]	87
Vertical Oxygen Tank Holder	88
Kinetec Oxygen Tank Holder	88
Transport Shelf	89
Head Extension [P752801/P752802/P752803]	90

Proning Kit [P7529]	91
Experience Pod Device [Overhead Arm] [P7546A01]	93
Safety Information	97
Bed Positions	97
Brakes	97
Magnetic Resonance Imaging	97
Fluids	97
Siderails	97
Footboard	98
Restraints	98
Electricity	99
Parts and Accessories	99
Operating Bed/Surface Precautions	100
Sleep Surface/Mattress	100
Flammability	101
Bed Articulations	101
Visitor Notification	101
Patient Transfer	101
Traction Equipment	102
IntelliDrive Transport System Batteries	102
Large Patient Product Performance	102
Atmospheric Pressure Product Performance	102
Preventive Maintenance	103
Power Conservation	104
Transportation Mode	104
Decommissioning and Disposal Instructions	104
Expected Life	105
Cleaning/Disinfecting	105
Recommendations	106
Cleaning and Disinfection	107
Prepare the Bed for Cleaning and Disinfection	107
STEP 1: Cleaning	108
STEP 2: Disinfection	109
Prepare the Bed for Use	109
Laundry Guidelines	110

Technical Specifications	111
Electromagnetic Emissions Guidance	116
Electromagnetic Immunity Guidance	118
Electromagnetic Immunity Guidance	119
Wireless Connectivity Specifications—External Wireless Module	121
General Wireless Recommendations	121
Wireless Connectivity Specifications	121
Wireless System Characteristics	122
WiFi and Bluetooth Radio Approval	123
Regulatory Information	123
USA—Federal Communications Commission (FCC) Radiation Exposure Statement	123
Interference Statement for FCC	123
Canada—Industry Canada (IC)	124
Wireless Connectivity Specifications—Internal Wireless Module	125
General Wireless Recommendations	125
Wireless Connectivity Specifications	125
Wireless System Characteristics	126
WiFi and Bluetooth Radio Approval	127
Regulatory Information	127
USA—Federal Communications Commission (FCC) Radiation Exposure Statement	127
Interference Statement for FCC	128
Canada—Industry Canada (IC)	128
Product Configuration Identification	129
P7500A Beds with a P7520A Surface	129
P7500A Bed with a P7540A Surface	130
Other Surfaces	132
Mattress Connection Troubleshooting	133

INTENDED USE

The **Progressa** Bed is intended to be used to treat or prevent pulmonary or other complications associated with immobility; to treat or prevent pressure ulcers; or for any other use where medical benefits may be derived from either Continuous Lateral Rotation Therapy or Percussion/Vibration Therapy. The **Progressa** Bed is intended to provide a patient support to be used in health care environments. The **Progressa** Bed may be used in a variety of settings including, but not limited to, acute care, including critical care, step down/progressive care, medical/surgical, high acuity sub-acute care, post anesthesia care unit (PACU), and sections of the emergency department (ED). The **Progressa** Bed is capable of being used with a broad patient population as determined appropriate by the caregiver or institution.

The intended users of this product are healthcare employees who have been trained to use the product, and who have the physical strength and cognitive skills to operate and control the product. There are some controls and features on the bed which may be used by the patients and family members upon appropriate orientation by the caregiver. Follow facility safety protocols if a patient does not have the physical strength or cognitive skills to operate and control the product safely.



CONTRAINDICATION:

Contraindication—To help prevent serious patient injury, be aware of these **contraindications**:

- **Contraindication**—Use of active air therapy surfaces for patients with unstable spinal cord injury could cause serious injury to the patient.
- **Contraindication**—Use of continuous lateral rotation therapy is contraindicated for patients with cervical or skeletal traction.



WARNING:

Warning—Do not use the product outside of the patient range. Patient entrapment, asphyxiation, or skin breakdown could occur.

The intended patient range is 70 to 500 lb (32 to 227 kg) and 59" to 74" (150 to 188 cm).

INTRODUCTION

This manual provides the required information for normal operation of the **Progressa** Bed from Hill-Rom. Before operating the **Progressa** Bed, be sure that you have read and understood in detail the contents of this manual. It is important that you read and strictly adhere to the aspects of safety contained in this manual.

Any reference to a side of the bed is from the patient's view lying in the bed.

The GCI bed image on the left side of the patient has the head of bed to the right as matches the orientation of the bed itself. The GCI bed image on the right side of the bed do not match the head/ foot orientation of the bed.

The bed is equipped with a scale intended to weigh the patient in the bed.

To identify which revision of the bed you have, look at the serial number label. The label is on the right or left side of the upper frame at the head end of the bed.

The letter (not shown in the label below) that follows P7500 identifies the bed revision.

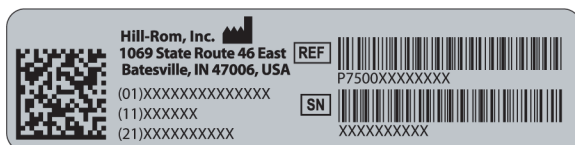

A single beep will sound when an activity is successful. A triple beep will sound when there is an error or caregiver attention is needed. A message will appear on the GCI screen for further instructions.

NOTE:

Throughout this manual the wall outlet for the electrical AC power (mains power), we identify as AC power.

SYMBOLS

DOCUMENT SYMBOLS

These symbols are used in the manual:

- Standard text—used for regular data.
- **Boldface text**—emphasizes a word, phrase, or trademark.
- **NOTE:**—sets apart special data or important instruction clarification.
 - CONTRAINDICATION, WARNING, or CAUTION



Contraindication—identifies situations or actions that may have an effect on patient safety. The equipment or therapy should not be used if the associated circumstances exist.



















Warning— identifies situations or actions that may have an effect on patient or user safety. To ignore a warning could cause patient or user injury.





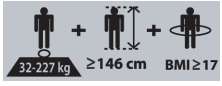







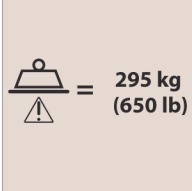

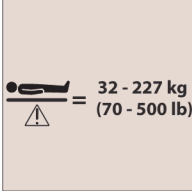



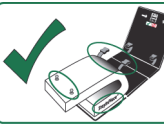















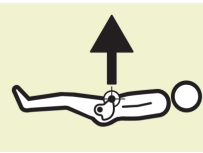

Caution—identifies special procedures or precautions that persons must obey to help prevent equipment damage.

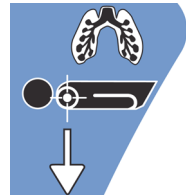





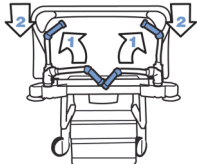

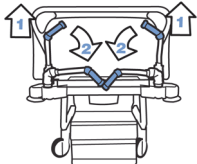

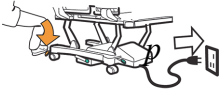



PRODUCT SYMBOLS

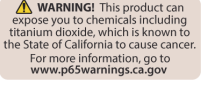







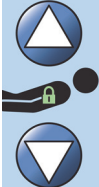









These symbols may or may not be on the **Progressa** Bed:





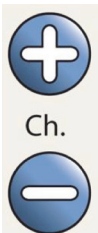
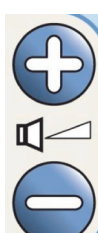





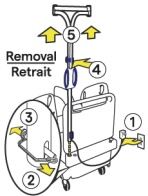

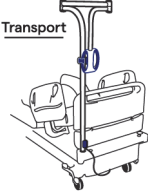







Symbol	Description	Symbol	Description
	Type B applied part according to EN 60601-1		Medical - General Medical Equipment as to Electrical Shock, Fire and Mechanical Hazards only in accordance with ES60601-1, EN60601-2-52, and CAN/CSA C22.2 No. 60601-1.
	WARNING (yellow and black)		Medical Device
	CAUTION (white and black)		Catalog number
	Conforms to the European Medical Device Directive 93/42/EEC. (The CE mark was first applied in 2013)		Serial number
	Manufacturer		Refer to the user manual for more information.
	Date of manufacture		Must consult the user manual.
	Scale class identifier—Identifies the scale as EN 45501 Class III.		Medical Bed for Adults.
	Manufacturer or distributor complies with the Waste Electric and Electronic Equipment Directive 2002/96/EC.		Black M on green background—Signifies the scale (NAWI EN 45501 only) is certified to weigh in approved positions)
	Beds with Serial Numbers after R217AW4088, with the NAWI EN 45501 scale. CE—Shows that the scale meets the requirements of the NAWI directive. M— Shows that the scale is certified to weigh in approved bed positions. ZZ—Numeric digits show the year of manufacture. 0122—Shows the Certifying Notified Body.		Beds with Serial Numbers before R217AW4088, with the NAWI EN 45501 scale. CE—Shows that the scale meets the requirements of the NAWI directive. XX— Numeric digits show the year of manufacture. 0122— Shows the Certifying Notified Body.



















Symbol	Description	Symbol	Description
	Identifying mains fuse		Identifies battery installation location
	Safe Working Load symbol for the bed and accessories.		Total bed weight including the safe working load is 635 kg (1400 lb); the bed weight excluding the safe working load is 340 kg (750 lb) minimum.
	Patient Weight for the bed—located on the frame under the head section.		Patient Weight for the bed—located on the foot section.
	Surface compatibility identification		Identifies a non-StayInPlace bed. Consult accompanying documents.
	Identifies a StayInPlace bed		Identifies that a Progressa Prevention Surface with the Chair Egress feature must be used for the Chair Egress function.
	Identifies a non-approved foam surface. Consult accompanying documents.		CPR function—Identifies the release lever, and direction of travel (refer to “CPR Control” on page 10).
	Transport position warning (refer to “Transport” on page 51).		Crush Warning: Must consult accompanying documents.
	Identifies Brake/Neutral/Steer position for the brake pedal.		Crush Warning.
	Identifies Brake/Neutral/Steer position for the steer pedal.		Foot pinch location.

Symbol	Description	Symbol	Description
	Do not stand on the footboard (refer to page 50).		Do not store cords here.
	Do not sit on the footboard (refer to page 50).		Warning: Do not put equipment on the base of the bed. Equipment damage could occur.
	Warning: Caregiver pendant only (refer to page 24).		Protective Earth
	Warning: Transport shelf only (refer to page 89).		Hip Locator (refer to page 12).
	Identifies auxiliary outlet power cord.		Shoulder Locator (refer to "Rotation" on page 77 or page 80).
	Identifies bed power cord.		Warning: Identifies auxiliary receptacle.
	Electrical Shock Hazard—unplug the bed before you clean or service the bed.		Do Not Use with Oxygen Tents—indicates the use of oxygen administering equipment of the nasal, mask, or ventilator type only or oxygen tents that can be contained inside the siderails. Label can be green or blue.
	IntelliDrive Transport System		Departure Transport Handle Sequence—raise and lock transport handles in position (refer to page 51).
	Departure Transport Sequence—unplug the bed and release the brakes (refer to page 51).		Arrival Transport Handle Sequence—stow the handles (refer to page 51).

Symbol	Description	Symbol	Description
	Arrival Transport Sequence—set the brakes and plug in the bed (refer to page 51).		Federal Communications Commission (on the Wireless Connectivity module) (refer to page 65).
	Radio Equipment Directive 2014/53/EU on the Wireless Connectivity module) (refer to “Wireless Connectivity” on page 65).		Wireless indicator (on the Wireless Connectivity module)—identifies the connection status of the wireless module to the facility wireless network (refer to page 66).
	Location indicator (on the Wireless Connectivity module)—identifies the connection status of the Location feature (refer to page 66).		Connected indicator (on the Wireless Connectivity module)—identifies the connection status of the wireless module to SmartSync System (refer to page 66).
	Product complies with RoHS 2 Directive 2011/65/EU		Warning: California prop 65 label
	This symbol is a sign of confirmation of compliance with the regulations of the Eurasian Customs Union.		Complies with Australian radio communications requirements
Siderail Symbols			
	Lockout control—Lock out articulation controls or the GCI screen (refer to page 14).		Bed Up and Down control (refer to page 15).
	Control lockout—comes on when a bed articulation control is locked out. Located next to the articulation control.		Knee Up and Down control (refer to page 16).
	Trendelenburg control (refer to page 13).		Head Up and Down control (refer to page 16).

Symbol	Description	Symbol	Description
	Reverse Trendelenburg control (refer to page 13).		Chair position control (refer to page 19).
	Bed flat control (refer to page 22).		Max-Inflate/P-Max control (refer to page 24).
	Side Exit Assist (refer to page 24).		Boost Position System control (refer to page 19).
	FlexAfoot Foot Extend/Retract control (refer to page 18).		Foot Elevate (Foot Up/Down) control (refer to page 17).
	Enable control—on the caregiver pendant (refer to page 24).		Nurse Call control (refer to page 23).
	Music control (refer to page 84).		Room Light control (refer to page 84).
	Reading Light control (refer to page 84).		Television control (refer to page 84).
	Television Channel control—patient controls only (refer to page 85).		Volume control—patient controls only (refer to page 85).
	Bed battery charge status (refer to page 11).		Bed not in lowest position indicator—Comes on when the upper frame is not in the lowest position (located on the GCI screen and on the caregiver control pod on the siderail).
	Maintenance required (refer to page 12).		

Symbol	Description	Symbol	Description
Experience Pod (overhead arm) Device Option			
	Steps to remove the overhead arm (refer to page 93)		Watch doors and walls during transport with an overhead arm (refer to page 93)
	Transport position of the overhead arm (refer to page 93)		Do not allow the patient to use the overhead arm to assist them to get out of bed (refer to page 93)
Graphical Caregiver Interface (GCI) Control Symbols			
	Home menu screen—press to return to the GCI home screen (refer to page 26).		Therapy menu control—press to go to the Therapy section on the GCI screen (refer to page 26).
	Alerts menu control—press to go to the Alerts section on the GCI screen (refer to page 26).		Reminders control—press to go to the Reminders section on the GCI screen (refer to page 26).
	Scale menu control—press to go to the Scale section on the GCI screen (refer to page 26).		Settings/Preferences menu control—press to go to the Preferences section on the GCI screen (refer to page 26).
	Surface menu control—press to go to the Surface section on the GCI screen (refer to page 26).		Wireless indicator on the GCI screen—identifies the operational status of the wireless connectivity module (refer to page 65).
Additional GCI Symbols (see “Graphical Caregiver Interface (GCI)” on page 26).			
	Help		Bed Zeroed/Tared
	GCI Lock		Bed Zeroed
	Pre-emptive Silence		Rotation Therapy ON
	Bed Exit Alert OFF		Percussion and Vibration Therapy

Symbol	Description	Symbol	Description
	Bed Exit: Position Alert ON		Surface: Normal
	Bed Exit: Exiting Alert ON		Surface: Normal Continuous Low Pressure (CLP) ON
	Bed Exit: Out of Bed Alert ON		Surface: Alternating low pressure (ALP) ON (optional)
	Bed Not in Lowest Position		Surface: Left Turn Assist
	Bed in Lowest Position		Opti-Rest™ ON
	Surface: Sleep Mode		Trendelenburg
	Surface: Seat Deflate		Reverse Trendelenburg
	Surface: Max-Inflate/P-Max Inflate		Bed Flat
	Surface: Right Turn Assist		Head of Bed Alert OFF
	Head of Bed Alert ON		

CPR CONTROL

The red CPR control pedals are located on each side of the base frame between the head-end and foot-end casters.

USE THE CPR CONTROL

When connected to AC power, the **HandsFree** CPR Control lowers the head and knee sections, and raises the foot section. After the head section is flat, a tone sounds and the foot section rises. The foot section moves to a flat position within a maximum of 30 seconds if fully articulated.

The integrated air surface will Max-Inflate/P-Max Inflate to provide a firm surface to support a CPR board. After 60 minutes of Max-Inflate/P-Max Inflate, the optional air surface will go into Normal mode. If AC power is lost, the air surface stays at the level of pressure that existed at the time of power loss.

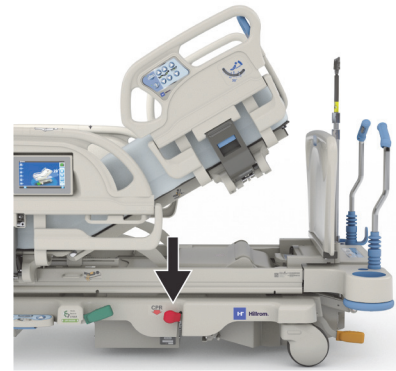

To Activate



WARNING:

Warning—Do not use your hand to activate the CPR foot pedal. Injury could occur.

1. Step down and hold the red CPR pedal with your foot until the head section reaches the flat position and you hear the audible tone. If you release the CPR pedal before the bed is flat, the head section will stop.
 - The foot and knee sections will automatically move to a flat position from any position including chair.
2. The surface automatically goes into Max-inflate/P-Max Inflate for 60 minutes. After 60 minutes the surface will go into Normal/Standard mode.

NOTE:

Use of a CPR board may increase the effectiveness of CPR.

3. To stop foot section movement, press any other siderail control except Nurse Call.
4. To stop Max-Inflate/P-Max Inflate, press the Surface menu control on the GCI home screen. Then press Normal.



NOTE:

When the AC power is lost, the head section will lower and the foot section will raise. The optional integrated air surface will not Max-Inflate and CPR board effectiveness may be reduced.

The Bed Up/Down controls are usable when the CPR function is activated.

When CPR is activated, any controls that are locked out will become unlocked.

ALERTS AND INFORMATION INDICATORS

The Information Indicators provide the caregiver with visual indications about: Audible Indicators, Battery Status, Service Required, Hip Position Locator, and head section angle.

AUDIBLE INDICATORS

A single beep will sound when an activity is successful.

A triple beep will sound when there is an error or caregiver attention is needed. A message will appear on the GCI screen for further instructions.

BED BATTERY POWER

Charged - The Charged indicator (+) comes on when the battery is charged.

Low - The Low indicator (-) flashes when the battery is low. An intermittent tone sounds every two minutes when the battery reaches low condition and AC is unplugged.

Off - If the battery is too low to operate the bed.

NOTE:

If the bed is unplugged, press any function to activate the battery power status.

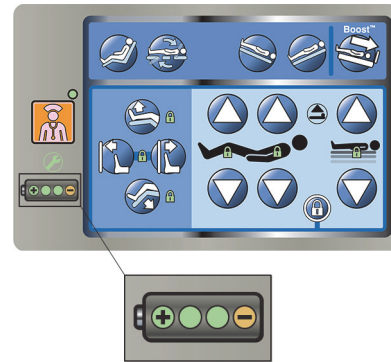

CAUTION:

Caution—Although a fully-charged battery is preferred, transport may be done when the battery charge is low. The bed should be reconnected to AC power as soon as possible to prevent equipment damage.

If the Battery Indicator changes from Charged to Low consistently within four hours of being disconnected from AC power, the battery should be replaced.

While on battery power, the following will happen:

- All bed articulations will operate
- Integrated surfaces will remain inflated, but will not adjust pressures
- The GCI screen will not display

SERVICE REQUIRED

The Service required indicator illuminates when the bed detects a malfunction. Contact the facility maintenance department for assistance.

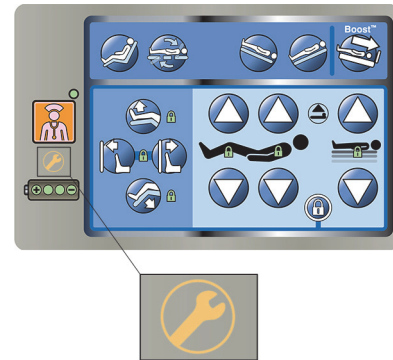

HIP POSITION LOCATOR

A hip position label appears on the intermediate siderails to indicate the correct position of the patient's hips while on the bed. The labels are on the top of the intermediate siderail just above the caregiver controls.

Proper placement of the patient increases the effectiveness of the **SlideGuard** Patient Position Mechanism and StayInPlace Patient Position Mechanism. These minimize migration of the patient to the foot end of the bed when you raise the head section.

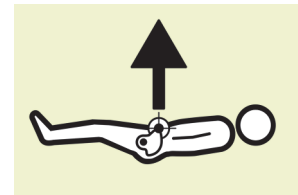

LINE-OF-SITE HEAD ANGLE INDICATOR

The head angle indicators mechanically indicate the approximate angle of the head section from -15° to $+80^{\circ}$ with respect to the floor. The head siderails contain head angle indicators on their outboard sides. The degree where the indicator ball rests is the correct angle. The angle indication is also shown on the home screen on the GCI screen.

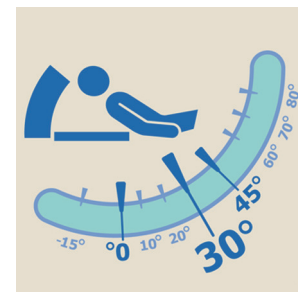

BRAKE NOT SET ALERT

The Brake Not Set is an audible and visual alert. The alert will sound, and a message will show on the GCI screen, when the bed is connected to an AC power source and the brake is not set.

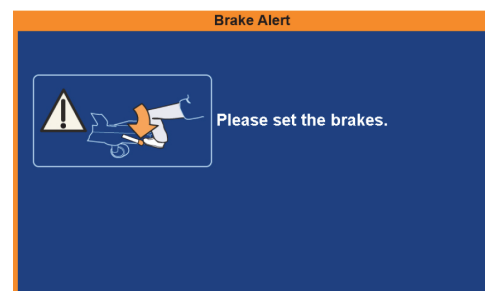

CAREGIVER SIDERAIL CONTROLS



WARNING:

Warning—To help prevent injury and/or equipment damage, obey these warnings:

- **Warning**—Instruct visitors not to use caregiver controls at any time. Visitors may assist patients in the use of patient controls.
- **Warning**—If the bed fails to respond to user inputs, unplug it and have it serviced.

This section describes the siderail controls of the bed that are intended to be used by the caregiver. Not all controls listed are present on all beds.



RAISE AND LOWER THE SIDERAILS



WARNING:

Warning—Evaluate patients for entrapment risk according to facility protocol, and monitor patients appropriately. Make sure that all siderails are fully latched when in the raised position. Failure to do either of these could cause serious injury or death.

Siderails may service as a benefit to provide bed exit assist and access to caregiver interface and patient controls. The use of siderails also may provide a sense of security. Siderails should always be in the upright and latched position when the bed is in the chair position. The use of siderails in the bed position should be determined according to patient need after accessing any risk factors according to the facility protocols for safe positioning.

When raising the siderails, a click indicates that the siderails are completely raised and locked in place. Once the click is heard, gently pull on the siderail to make sure the siderail is latched in position.

Siderails are intended to be a reminder to the patient of the bed's edges, not a patient-restraining device. When appropriate, Hill-Rom recommends that medical personnel determine the proper methods necessary to make sure a patient remains safely in bed.

Siderails in the raised position are intended to make the patient aware of the proximity of the edge of the sleep surface.

Siderails in the down position, below the patient surface, facilitates a patient's entry or exit from the bed. This design feature also facilitates unobstructed access to the patient.

To Raise the Siderail

1. Pull the siderail up until it latches into the locked position.
2. When you raise the siderails, a **click** will be heard when it latches into the locked position.
3. Once the **click** is heard, gently pull on the siderail to make sure it is latched properly.

To Lower the Siderail

1. Grasp the release handle and push up.
2. Lower the siderail.



SIDERAIL CONTROLS LOCATION

The **Point-of-Care** Siderail controls are located on the outboard side of the siderails.

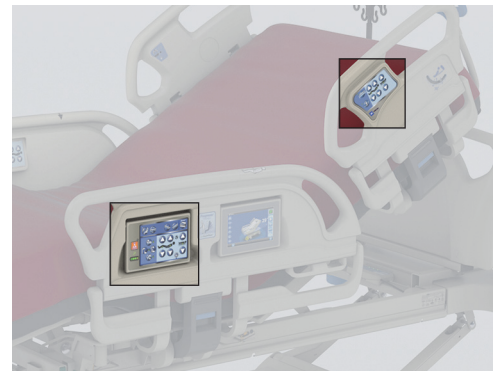

LOCKOUT CONTROLS

The Lockout controls are located on the intermediate siderail caregiver control panel. The Lockout controls disable the bed articulating functions. The Lockout controls are used when it is necessary to prevent bed movement. Emergency CPR will not be locked out. If CPR is activated, any controls that are locked out will become unlocked.

Follow facility protocol for lock outs to reduce the likelihood of unauthorized use of the bed controls.

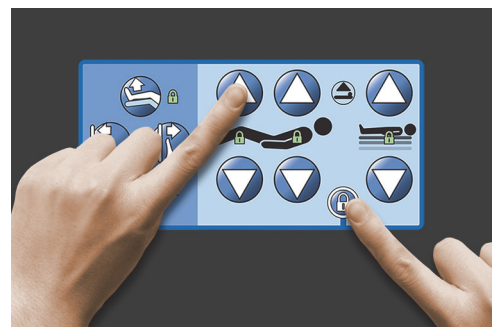

**WARNING:**

Warning—Lock out all articulation controls when traction equipment is installed. Failure to do so could cause patient injury.

To Activate

- At the same time press the Lockout control and the function control.
 - A single beep sounds and the locked function indicator will stay on. Both patient and caregiver controls are locked out.
 - If the lock out procedure is done incorrectly, the bed will beep three times and a screen will show on the GCI screen to show the correct procedure.
 - The knee lockout will lock out the foot control. The foot Up/Down lockout will lock out the knee control.
 - The bed up down lockout will lock out Trendelenburg and Reverse Trendelenburg.
 - Any lockout will also lock out all chair positions and bed flat.

To Deactivate

- Disable any lockout by simultaneously pressing the Lockout control and the respective function control. A single beep will sound when the lockout is deactivated.

BED UP/DOWN

The Bed Up/Down controls are located on the head-end siderails and on the intermediate siderails. They adjust the height of the bed from a low position for patient exit to a high position for examination. To lock out a control, refer to “Lockout Controls” on page 14.

**WARNING:**

Warning—Lowering the bed may cause linens, drainage bags, and other equipment to come in contact with the floor. Follow facility protocol if they touch the floor.

**CAUTION:**

Caution—Make sure there is sufficient headwall clearance when you raise/lower the bed. Equipment damage could occur.

To Activate

- Press and hold the Bed Up control to raise the bed or press and hold the Bed Down control to lower the bed. Release the control when the desired height is reached.
- To disable the Bed Up/Down - Activate the Up/Down lockout control.

NOTE:

While holding the Bed Down button, the bed motion will slow down just before reaching the lowest position. Continue holding the Bed Down button until the bed stops completely. When the bed reaches the lowest position, the “Bed Not in Low position indicator” on the intermediate siderail control panel will go out and the bed position indicator on the home screen of the GCI screen will turn green.

HEAD UP/DOWN

The caregiver can raise or lower the head section by using the Head Up/Down controls. Use the **Line-of-Site** Angle Indicators on the siderails or the GCI screen to see the specific angle. To lock out a control, refer to “Lockout Controls” on page 14.

To Activate

- Head Up—Press and hold the Head Up control to raise the head section. Release the control at the applicable position.
- Head Down—Press and hold the Head Down control to lower the head section. Release the control at the applicable position.



Additionally, the bed is equipped with an Auto Contour mode. When the Head Up control is pressed, the Auto Contour mode raises the knee section to a maximum of 20°. When the head section is lowered, the knee section will go to the flat position.

- Auto Contour Feature - Press and hold the Head control. The head and knee sections rise together to reduce patient migration toward the foot end of the bed.



To Disable Auto Contour

Activate the Knee lockout control or press the Knee down control while you press the Head Up control to prevent the knee from moving.

StayInPlace Feature

Developed by Hill-Rom’s ergonomic research labs, the optional StayInPlace advanced articulation technology mimics the natural movement of the patient that occurs while transitioning between the supine and upright positions. The StayInPlace Feature helps keep patients optimally positioned to minimize migration toward the foot end of the bed as the head of bed is raised.

KNEE UP/DOWN

The caregiver can raise or lower the knee section by using the Knee Up/Down controls. To lock out a control, refer to “Lockout Controls” on page 14.

To Activate

- Knee Up—Press and hold the Knee control to raise the knee section.
- Knee Down—Press and hold the Knee control to lower the knee section.



The Auto Contour feature does not change the head angle when only using the Knee Up/Down controls.

FOOT ELEVATE (FOOT UP/DOWN)

The foot section angle can be changed by using the Foot Up/Down controls. To lock out a control, refer to “Lockout Controls” on page 14.

NOTE:

The Foot Up control also operates the Leg Elevation feature (refer to “Lower Leg Elevation (Vascular Position)” on page 17).

Foot Down

The foot section can be lowered from zero (flat) to approximately 70 degrees down from horizontal.

To Activate Foot DOWN

Press and hold the Foot Down control to lower the foot section.



Foot Up

The foot section can be raised from 70 degrees below horizontal to flat.

To Activate Foot UP

Press and hold the Foot Up control. The foot section will raise if it had been previously lowered using Foot Down.



NOTE:

The Foot Up control also operates the Lower Leg Elevation.



WARNING:

Warning—To help prevent injury and/or equipment damage, obey these **warnings**:

- **Warning**—Lowering the foot section may cause linens, drainage bags, and other equipment to come in contact with the floor. Follow facility protocol if they touch the floor.
- **Warning**—Do not use ankle restraints when you activate this feature.



CAUTION:

Caution—Before you activate the foot section controls, make sure the area around the foot section is clear of equipment, or equipment damage may occur.

Lower Leg Elevation (Vascular Position)

The foot and lower leg section can be raised into a vascular position by using the Foot Up control. This position is achieved by the leg raising in combination with Trendelenburg and head section movement.

NOTE:

Lock out head controls if you do not want the head angle to raise or Trendelenburg to operate. To lock out a control, refer to “Lockout Controls” on page 14.

To Activate Lower Leg Elevation

1. Press and hold the Foot Up control. The foot section will raise. Once the foot section is at maximum elevation, the head of bed will raise approximately 15 degrees, then the bed will move into Trendelenburg to raise the foot higher than the head.
2. Release the Foot Up control when the desired position is reached.

NOTE:

Another way to do this is Press Knee Up instead of Foot Up, then use the Trendelenburg control. Alternately press Head up and Trendelenburg if you wish to adjust the head of bed angle with respect to Trendelenburg.

FLEXAFOOT FEATURE (FOOT EXTEND/RETRACT)

The length of the bed can be adjusted using the extend or retract controls. This feature allows the **Progressa** Bed to be customized to the patient's height. The foot section can be retracted 10" (25 cm). To lock out a control, refer to "Lockout Controls" on page 14.

Make sure that the footboard is approximately 1-2" (25-51 mm) from the patient's heels.

To Activate:

- Press and hold the Foot Extend control to extend the foot section.
- Press and hold the Foot Retract control to retract the foot section.



WARNING:

Warning—Do not use ankle restraints when you activate this feature; injury to the patient may occur.

TRENDELENBURG OR REVERSE TRENDELENBURG

The **Progressa** Bed is capable of 13° Trendelenburg. Reverse Trendelenburg can achieve 18° (beds without Chair Egress) or 20° (beds with Chair Egress). The powered Trendelenburg and Reverse Trendelenburg controls can be activated at any bed height.

NOTE:

Retract the foot section to achieve full Reverse Trendelenburg.



WARNING:

Warning—Trendelenburg/Reverse Trendelenburg may cause linens, drainage bags, and other equipment to come in contact with the floor. Follow facility protocol if they touch the floor. Injury could occur.



CAUTION:

Caution—While articulating in the Trendelenburg position, make sure there is adequate headwall clearance. Equipment damage may occur.

To Activate

- Trendelenburg - Press and hold the Trendelenburg control. The foot end of the bed raises relative to the head end.
- Reverse Trendelenburg - Press and hold the Reverse Trendelenburg control. The head end of the bed raises relative to the foot end.



To Deactivate

- Press and hold the **Bed Flat** control to return the bed to the flat position (refer to "Bed Flat Control" on page 22).



or

Press the opposite control. (If in Trendelenburg - press Reverse Trendelenburg. If in Reverse Trendelenburg - press Trendelenburg.) When the level position is reached, the bed will pause.

If the foot section is in the down position when Reverse Trendelenburg is activated, the foot section will automatically raise. This prevents the articulated foot section from interfering with the floor.

NOTE:

The **Progressa** Bed will not move to the Trendelenburg/Reverse Trendelenburg position if the bed up/down controls are locked out.

BOOST POSITION SYSTEM

The **Boost** Position System assists with the movement of the patient to the head end of the bed.

The **Boost** Position System will not work if the bed up down controls are locked out.

1. Press and **hold** the Boost control on the siderail.
 - If the bed has an air system, the surface will go into Max-Inflate/P-Max Inflate for 30 minutes.
 - Flattens the head and foot.
 - May adjust bed height.
 - If desired, you can continue to hold the control, the bed will transition to the Trendelenburg position.
2. Release the Boost control when the desired position is reached.
3. Reposition the patient as needed.



To return to the flat position, press and hold the Bed Flat control and if the bed has an air system, press **Normal** on the GCI's Surfaces screen.

CHAIR POSITIONS

The Chair control is located on caregiver control panel or caregiver pendant.

The **Progressa** Bed will not move to a chair position if any of the articulation controls are locked out.

Look at the Chair image on the outside of the intermediate siderail to determine the chair positions your version of the **Progressa** Bed can achieve. Refer to "Product Configuration Identification" on page 129.

Use the chair control to put the **Progressa** Bed in one of three chair positions:

- **Dining Chair** control
- **Dining Chair** control, **FullChair** control, and Chair Egress control
- **Dining Chair** control, **FullChair** control, and Chair Egress control with an Air Surface



When you press and hold the Chair control, the bed will move through all of the chair positions. Instructions will show on the GCI screen as the bed moves through the chair positions. Three beeps will sound when the instructions show on the GCI screen.

Dining Chair Position

The **Dining Chair** feature allows the patient to be placed in a customized semi-seated position.

To Activate

1. Make sure the brake is set.
2. Press and hold the Chair control. The patient deck transitions to the reclined position (first the patient deck will slightly recline backwards as the seat and lumbar sections of the surface slightly deflate.) When the Chair control is released, the seat section will re-inflate to normal pressures (air surface beds only).
3. When the bed has reached the desired position, release the Chair control. If desired, use the Head, Knee, Foot, or Foot Retract controls to make custom **Dining Chair** position adjustments.

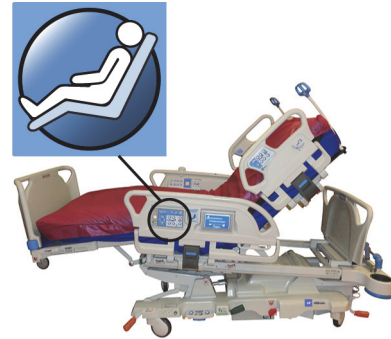

WARNING:

Warning—To help prevent injury and/or equipment damage, obey these **warnings**:

- **Warning**—Do not transport a patient with the bed in a **Dining Chair** position.
- **Warning**—Do not use ankle restraints when using this feature.
- **Warning**—Observe lines, drainage bags, and linens closely during chair positioning.

FullChair Position

The **FullChair** feature is only available on beds with Chair Egress. It allows the caregiver to place the patient in a fully seated position without having to remove the patient from the bed.

To Activate

1. Set the brake.
2. Press and hold the Chair control. The patient deck transitions to the reclined position (first the patient deck will slightly recline backwards as the seat and lumbar sections on the surface slightly deflate) then to the Chair position.
3. If the footboard is installed, when the articulation stops and a tone sounds, the bed has reached the **FullChair** position.

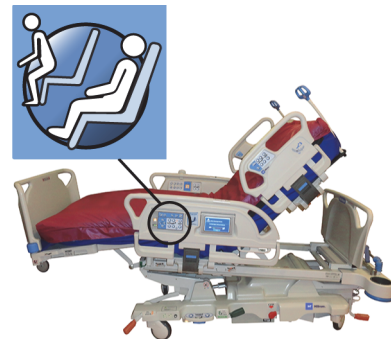

NOTE:

If the footboard is not installed, the bed will proceed into Chair Egress.



WARNING:

Warning—To help prevent injury and/or equipment damage, obey these **warnings**:

- **Warning**—Do not transport a patient with the bed in a chair position.
- **Warning**—Observe lines, drainage bags, and linens closely during chair positioning.



CAUTION:

Caution—Do not stand or sit on the footboard. Damage to equipment may occur.

Chair Egress

The chair egress feature allows the caregiver to easily position a patient to exit from the foot end of the bed by pushing and holding one control.

The chair egress position is intended to facilitate patient exit and not long-term sitting.

The head section moves to the full upright position, the foot section retracts and lowers completely, the bed lowers to its lowest height, the seat and leg sections deflate, the bed tilts and then the knee lowers. The back section can then be inflated to sit the patient straight up as an egress assist.

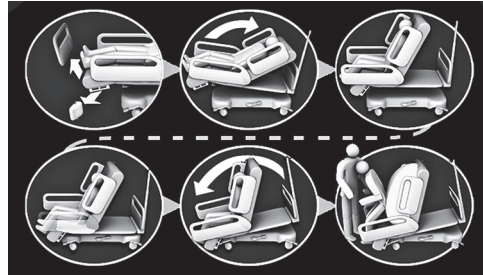

WARNING:

Warning—To help prevent injury and/or equipment damage, obey these **warnings**:

- **Warning**—Do not use the chair egress feature to return a patient to a **Progressa** Bed with the **Progressa** Prevention Surface. Adjust the bed to the flat position to return a patient to the bed.
- **Warning**—When the product is in the chair position and a caregiver is assisting a patient with ingress or egress, make sure that the caregiver has necessary assistance to proceed safely.

To Activate

1. Make sure the brakes are set.



WARNING:

Warning—When the footboard is removed from the bed, do not lay the footboard flat on the floor. Store the footboard in a position or location so that it does not come in contact with biohazards. Failure to do so could cause injury.

2. Remove the footboard if installed.

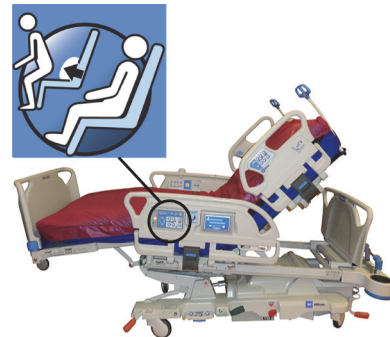

NOTE:

If the footboard does **not** have a transport shelf installed, the footboard can be set upright on the floor. If a transport shelf is installed, the footboard can be put against a wall in a position so that it will not fall.

3. Press and **hold** the Chair control until the bed reaches the **FullChair** position and lowers completely.

NOTE:

The patient deck first tilts back and then lowers as it goes to the **FullChair** position.

- Whenever the bed beeps three times, follow the on-screen prompts to help you through the correct procedure for Chair Egress.
 - Monitor the patient, patient lines, and drainage devices.
 - For patient comfort, remove patient pillows before moving the bed to the chair egress position.
 - For patient safety, remove the top sheet and any other items that may restrict leg movement before egressing the patient from the bed.
4. On beds with a **Progressa** Prevention Surface with the Chair Egress feature, continue to press and hold the chair control until the bed is at the chair egress position.

5. On beds with an air surface, the GCI screen will indicate when the seat is deflating. Wait until the surface deflates fully and the bed beeps three times.

NOTE:

Pressing cancel on the GCI screen will re-inflate surface.

6. Press and hold the Chair control again. The frame will tilt forward to put the patient's feet closer to the floor.
 - One beep will sound when maximum tilt is reached.
7. If needed, press and hold the Chair control to inflate the back section of the surface to the desired amount to assist with the patient egress.
8. Make sure the patient's feet are on the floor and clear of all obstructions and trip hazards including the deflated surface and linens. Monitor the patient and patient lines during bed egress. Assist the patient with egress.



WARNING:

Warning—Wait for the bed to complete all frame articulations and surface deflations and the patient's feet are touching the floor before the patient exits the bed. Patient injury could occur.

To Deactivate

To move the bed out of a chair position, press and hold the **Bed Flat** control.



WARNING:

Warning—To help prevent injury and/or equipment damage, obey these **warnings**:

- **Warning**—The patient's feet must be supported by the floor at all times while in the exit chair position. Injury to the patient may occur from improper positioning.
- **Warning**—Do not transport a patient with the bed in the chair egress position.
- **Warning**—Do not use ankle restraints when activating this feature.
- **Warning**—Observe lines, drainage bags, and linens closely during chair positioning.
- **Warning**—If bed sheets contact the floor during Chair Egress, follow standard infection control procedures.
- **Warning**—Make sure the that sheets and blankets are not in a location where a patient will step on them when they exit the bed. Bedding in a location where it can be stepped on presents a trip hazard that can cause patient injury.

BED FLAT CONTROL

Bed Flat controls are provided so that a caregiver can easily return the patient deck to the level position from any articulated position.

To Activate

1. Press and hold the **Bed Flat** control.
2. The intermediate frame returns to level from the tilted position.
3. The individual sections move to the flat position. If the bed is starting in the Chair position, then it will move through the Reclining position on the way to level.
4. When all sections are flat, the bed stops and one beep sounds.



SIDECOM COMMUNICATION SYSTEM

**WARNING:**

Warning—Failure to connect the **SideCom** Communication System cable may result in delay of critical care to the patient.

The **SideCom** Communication System option provides a control for Nurse Call and other entertainment features.

The **SideCom** Communication System connector is at the head end of the bed below the head board.



NURSE CALL

The patient can use the Nurse Call control to call the nurse when the control is lit.

When a Nurse Call control is activated, a signal is sent to the nurse's station. Voice communication is provided through a speaker/microphone that is on the inside of both head siderails. See "Sidecom Communication System" on page 23.

To Activate

Press a **Nurse Call** control. These will occur:

- The amber indicator near the Nurse Call control will come on and single beep will sound to let you know that the call has been sent.
- When the nurse station communication line is open, the indicator turns green. The nurses station is ready for you to speak.
- Speak into the speaker/microphone located on the inboard side of the head-end siderails.

**NOTES:**

- The Nurse Call controls are always lit, visible, and active if the bed is connected to a compatible Nurse Call System. If the Nurse Call control does not light when connected to the Nurse Call system, contact our authorized maintenance persons.
- The Nurse Control can not be locked out.
- The bed can communicate these alerts through the standard 37 pin cable:
 - Nurse call
 - Bed exit alert
 - Generic equipment alerts. These alerts require a custom **Hillrom** cable that plugs in to a standard phone jack wall plate.

MAX-INFLATE/P-MAX INFLATE (SIDERAIL METHOD)

To Activate

Press the Max-Inflate/P-Max Inflate control. The green indicator light will turn on.



To Deactivate

Press the Max-Inflate/P-Max Inflate control. The green indicator light will turn off.

Refer to “Max-Inflate/P-Max Inflate” on page 73 for an alternative method. This feature times out after 30 minutes.

SIDE EXIT ASSIST

The Side Exit Assist control inflates the seat section of the surface to assist in side exit of the bed. This feature times out after 30 minutes.

To Activate

1. Help the patient to a side sitting position on the edge of the surface.
2. Raise or lower the bed so the patient's feet will be flat on the floor.
3. Press the Side Exit Assist control on the head-end siderail.
4. After the seat section inflates, assist the patient with bed exit.



To Deactivate

Press the Side Exit Assist control on the head-end siderail.

CAREGIVER PENDANT CONTROLS

This section describes the pendant controls that are intended to be used only by the **caregiver**.



WARNING:

Warning—To help prevent injury and/or equipment damage, obey these **warnings**:

- **Warning**—The caregiver pendant is for use by the caregiver only. Do not allow the patient to use the caregiver pendant.
- **Warning**—The pendant is not for use inside of an oxygen tent.

There is an Enable control located on the caregiver pendant. The Enable control deters unauthorized operation of controls on the pendant. The Enable control is only required for the functions connected with the green line. The controls in the blue area do not require the Enable control to be activated.

The Enable indicator stays on for 60 seconds. While this indicator light is on, the caregiver can activate any pendant control.

To Activate

- Press and hold the Enable control until the indicator light comes on. The Enable indicator light stays on for 60 seconds.
- During the 60-second period, you may activate bed controls on the pendant without pressing the Enable control again.
- If the enable control process is done incorrectly, the bed will beep three times and instructions will show on the GCI screen.
- If during the 60-second enabled time you want to turn it off, press the Enable control. The indicator light will turn off when the Pendant controls are no longer enabled.

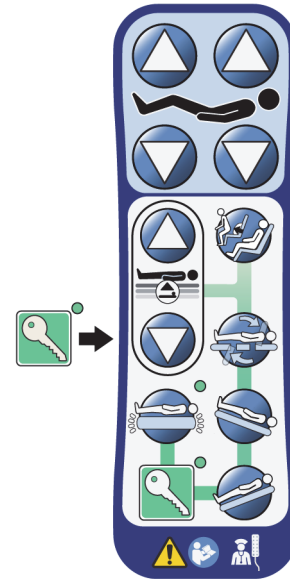
**To Remove from the Siderail or Footboard**

- Pull straight up on the pendant.
- or
- Rotate the pendant in a clockwise or counterclockwise direction until the mount clip disengages from the siderail or footboard.

**To Store****WARNING:**

Warning—Only store the pendant on the footboard or on the upper part of the intermediate siderail as shown. Do **not** store the pendant in these locations. To do so could cause patient injury or equipment damage:

- on the patient side of the siderails or footboard (except when the bed is in transport)
- under the surface
- on the lower part of the siderail
- on the patient restraint and drainage bag holders Push straight down on the pendant until the mount clip engages on the top of the intermediate siderail or the footboard.

GRAPHICAL CAREGIVER INTERFACE (GCI)

The GCI screen is located on the intermediate siderail next to the caregiver control panel.

To Activate

- Touch the screen.

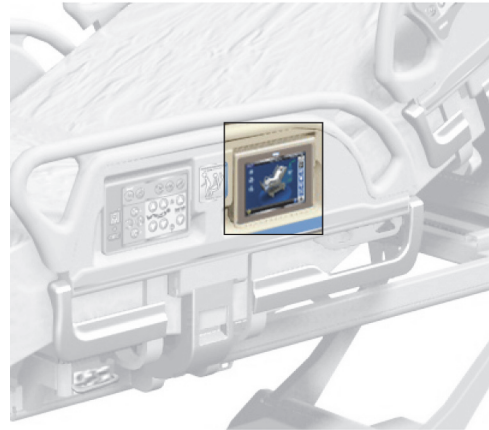

- Slide your finger across the screen at the location shown.

The screen will dim after 1 minute of not being touched. After 2 minutes of the screen not being touched the screen will lock. When locked, the screen information will still be visible but if the screen is touched the user will need to unlock it again.



Lock the GCI Screen

At any time the user can hide screen information by pressing the lock symbol in the lower left hand corner of the screen. The unlock screen will show until the screen is active.

HOME SCREEN DESCRIPTION

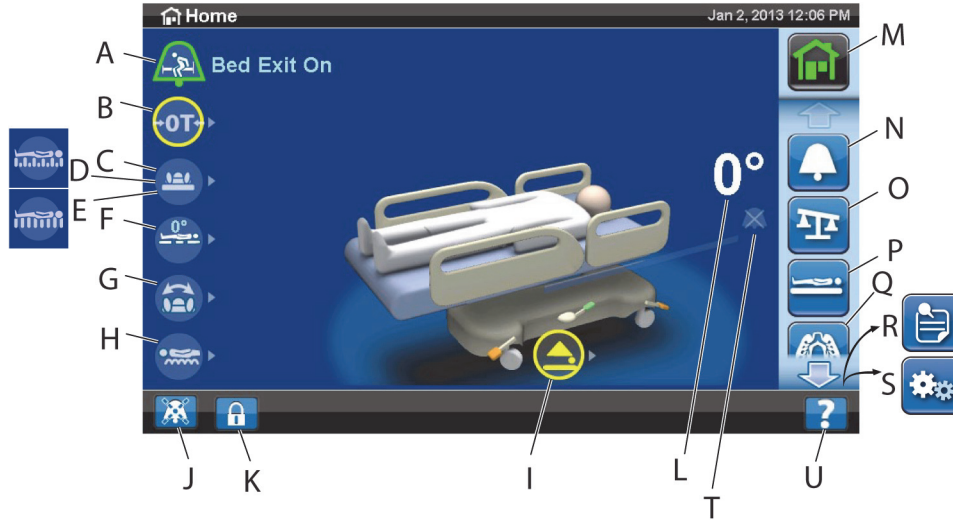

NOTE:

Not all indicators and controls are available on all beds.

Item	Description	Item	Description
Information Indicators —tap the indicators for status details.		Menu Controls —use the scroll arrows or slide your finger up and down on the menu bar to see the different menu options.	
A	Bed Exit status	M	Home
B	Bed Zeroed status	N	Alerts
C	Surface status	O	Scale
D	Alternating low pressure (ALP) ON	P	Surface
E	Normal (Continuous low pressure (CLP))	Q	Pulmonary Therapies
F	Trendelenburg status	R	Reminders
G	Rotation status	S	Settings/Preferences
H	Percussion and Vibration status		
I	Bed not in the lowest position		
Additional Controls and Indicators			
J	Pre-emptive Alert Silence control	T	Head of Bed Alert status indicator
K	Screen Lock control	U	Help control
L	Head Angle indicator		

The color on the upper border of the screen indicates these:

- Red or Orange = warning
- Yellow = caution
- Blue = instructions or information
- Green = task was successful

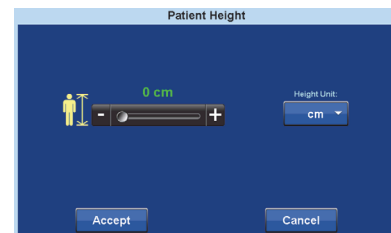
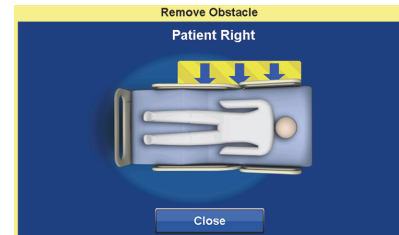
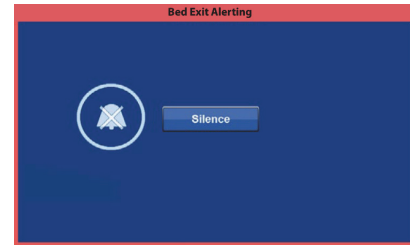



Help (?) Menu

Through the Help menu control at the bottom right of the screen, you can access additional instructions for many of the bed functions and features.

BED EXIT ALERT

Bed Exit Mode Descriptions

The Bed Exit Alerts system has three levels of sensitivity settings to select from:

<p>Patient Position Mode—this mode alerts when the patient moves towards either siderail or moves away from the head section, such as sits up in bed.</p>	
<p>Exiting Mode—this mode alerts when a patient moves away from the center of the bed towards an egress point.</p>	
<p>Out of Bed Mode—this mode alerts when the patient's weight shifts significantly off the frame of the bed.</p>	

Turn ON the Alert

1. Make sure the patient is centered on the bed and aligned with the hip locator.
2. Press the **Alerts** menu control on the GCI screen.



3. Press **Bed Exit**.

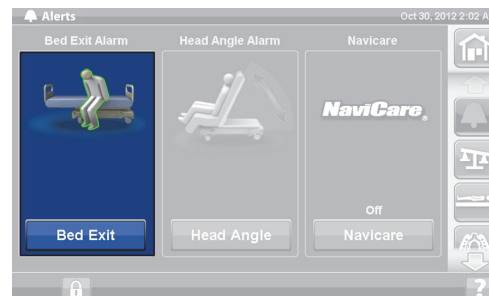

4. Press one of these:

- Position
- Exiting
- Out of Bed

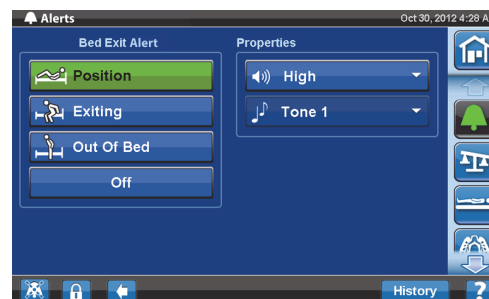

NOTE:

Only one bed exit mode can be active at a time.

A message will show when the bed exit alert is active.

- When armed, the alert indicator will turn green on the home screen and the center of the indicator will show the selected mode of sensitivity.

Patient Position Mode



Exiting Mode



Out of Bed Mode



NOTE:

If you want Bed Exit set during a pulmonary therapy (Rotation or Percussion and Vibration), Bed Exit must be initiated before starting the therapy. Only Out of Bed Mode will work during a pulmonary therapy.

Turn OFF the Alert

1. Press the **Alerts** menu control on the GCI screen.
2. Press **Bed Exit**.
3. Press **Off**. This turns off the Bed Exit Alert.

Pre-Emptive Alert Silence

When the Bed Exit System is on, it can be silenced with the Pre-emptive alert silence control in the lower left corner of the screen for 30 seconds and then suspended for 10 to 30 minutes without turning the system off.

To Activate the Pre-Emptive Alert Silence

Press the alarm silence control located at the lower left of the GCI screen. This will allow patient movement or procedures to be done without the alert sounding.



To Silence a Bed Exit Alert

When the bed exit system is activated, and it detects an alarm condition, an alert will sound and a message will show on the GCI screen.

Press Silence to acknowledge the alert. During the Silence mode, the system stops monitoring the patient movement; therefore the system does not turn on the audible alert or send a nurse call alert. While the system is in Silence mode, you can change the position of the patient or assist the patient out of the bed.

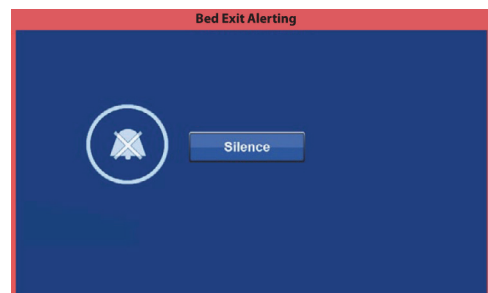

Then, a new screen shows where you can select: Resume, Suspend, or Alert Off. If nothing is selected on this screen the system will wait 30 seconds to allow the caregiver time to help the patient out of the bed, if for example the patient needs to use the bathroom.

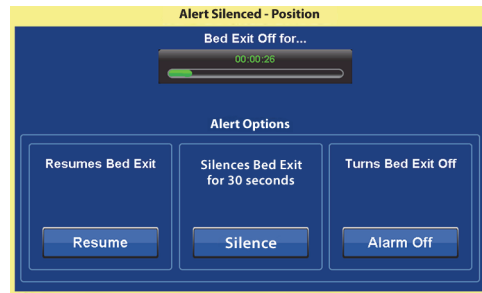

After the system has been in Silence mode for 30 seconds, the system will try to arm itself for the previously set Bed Exit mode.

- **Suspend**—if silence is not a long enough interval, suspend allows 10 to 30 minutes more time before the bed attempts to re-arm the alert. If the bed does not detect a patient after the time expires, the alert will sound. This time can be configured by your facility maintenance personnel.
- **Resume**—immediately turns on the bed exit alert on.
- **Alert Off**—turns the bed exit alert off.

Change the Alert Volume

The alert volume can be changed from the default value to something softer.

1. Press the **Alerts** menu control on the GCI screen.



2. Press **Bed Exit**.



3. Press the volume drop down menu to select the desired volume.

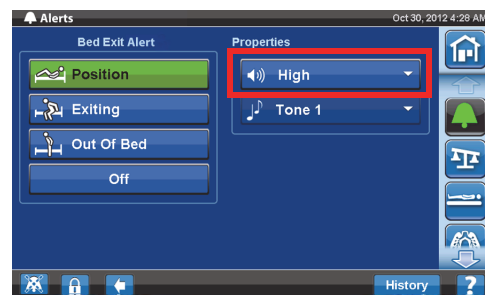

Change the Alert Tone

The alert tone can be changed. Contact your facility maintenance personnel.

HEAD ANGLE ALERT

The head angle alert lets the caregiver set an alert to sound if the head section goes below 30° or 45°. A message will show on the GCI screen when the head section goes below the angle setting.

To Activate

1. Raise the head section to the applicable position above 30° or 45°.
2. Press the **Alerts** menu control on the GCI screen.



3. Press **Head Angle**.



4. Press the head angle alert that you need.



5. A Head Angle Armed screen will show, press **OK**.

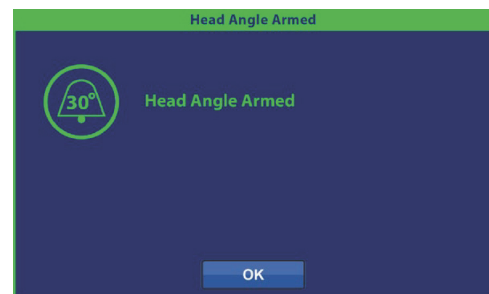

When an alert sounds

Raise the head section above 30° or 45°.

or

1. Press the **Alerts** menu control on the GCI screen.
2. Press **Off** to silence the alert.

SCALE

The Scale menu control on the GCI screen allows you to Zero the Scale (does not clear history), New Patient (clears history and zeroes scale), Weigh Patient, adjust the weight, add/remove items, change from pounds (lbs) to kilograms (kg) (available on some beds), calculate BMI, or view weight history.

If the bed has a pendant installed, make sure it is either on the siderail or footboard when you zero the scale or weigh a patient.

Scale specifications

NOTE:

Scale accuracy: 2.2 lb (1 kg) or 1% of patient weight, whichever is greater

Scale repeatability: 2.2 lb (1 kg) or 1% of patient weight, whichever is greater

The maximum scale capacity is 551 lb (250 kg), however the maximum patient weight for the bed is 500 lb (227 kg).



WARNING:

Warning—These warnings apply to both zero the scale and weigh procedures. To help prevent injury and/or equipment damage, obey these **warnings**:

- **Warning**—The scale is very sensitive. Make sure the bed is not touching anything that could affect the patient weight zeroing or weighing process. Failure to do so could cause an inaccurate weight reading.
- **Warning**—Always use the **New Patient** zero before a patient is admitted into the bed. Failure to do so may keep old patient data in the bed and cause a risk to the new patient.

Recommended Bed Position to Weigh a Patient and Required Bed Position to Zero the Bed

- Head lower than 45° (A; head angle).
- Foot not more than 30° below horizontal (B; foot up).
- Trendelenburg/Reverse Trendelenburg less than 2° (C; Trendelenburg angle).

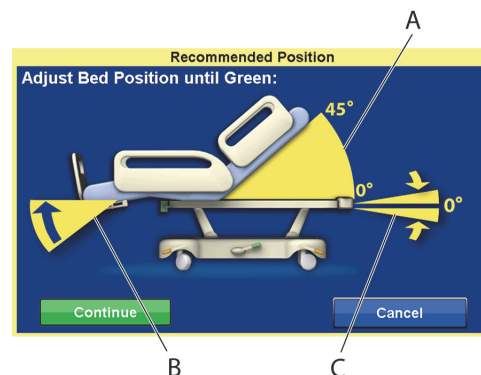

Zero/New Patient

1. Make sure the patient is not on the bed.
2. Put the bed in the required position (refer to “Recommended Bed Position to Weigh a Patient and Required Bed Position to Zero the Bed” on page 33).
3. Press the **Scale** menu control on the GCI screen.



4. Press **Zero**.

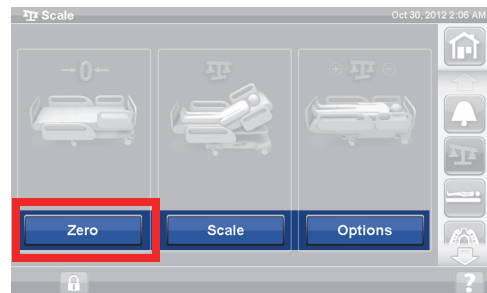

5. Press:
 - **New Patient**
 - Erases Scale History (all previously recorded patient weights will be erased)
 - Zeroes the scale
 - Returns the surface to Normal mode
 - Turns off all RemindMe reminders

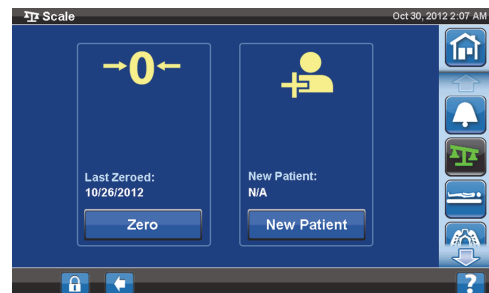

or

- **Zero**
 - Does **not** erase Scale History
 - Zeroes the scale
6. Follow the on-screen instructions.
 - If during Zero or New Patient, the “Not Required Position” message shows on the GCI screen, adjust the bed as applicable.

Weigh the Patient



WARNING:

Warning—Incorrect use of the scale can result in inaccurate patient weights, which could result in harm to the patient.

1. Make sure the patient is centered and laying on the bed.
2. Move any drainage bags on the bed to the green hooks under the foot end of the sleep deck.
 - You can weigh in the non-recommended position; however, non-recommended positions may reduce accuracy and repeatability.
 - Items on the IV poles or in the oxygen tank holders at the **head-end** of the bed are not weighed.

3. Press the **Scale** menu control on the GCI screen.



4. Press **Scale**.

NOTES:

- Remove everything attached to the upper frame, siderails, and foot end of the bed or the items will be included in the patient weight.
- The headboard and devices mounted to the head end of the bed **will not** be included in the patient's weight.

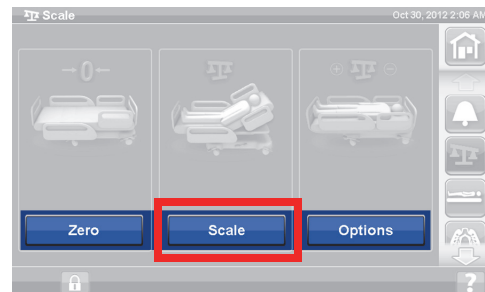

5. Press **Weigh Patient**. Follow the on-screen instructions.

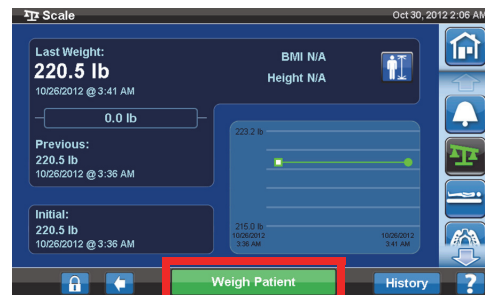

6. Press **Accept** or Re-weigh.

- Re-weigh—bed will repeat the steps to weigh the patient
- Accept—stores the weight in the history



7. Return the drainage bags to the drainage bag holders on the bed.

8. Follow the on-screen instructions.
 - If during Zero or New Patient, the “Not Required Position” message shows on the GCI screen, adjust the bed as applicable.
9. To protect the privacy of the patient, do not leave the patient weight displayed on the screen. Return to the Home screen by pressing the **Home** control on the GCI screen.

BODY MASS INDEX (BMI) CALCULATOR

Body Mass Index (BMI) is a number calculated from a person's weight and height. BMI does not measure body fat directly, but research has shown that BMI correlates to direct measures of body fat, such as underwater weighing and dual energy x-ray absorptiometry (DXA). BMI can be considered an alternative for direct measures of body fat.

To Activate

1. Press the **Scale** menu control on the GCI home screen.



2. Press **Scale**.

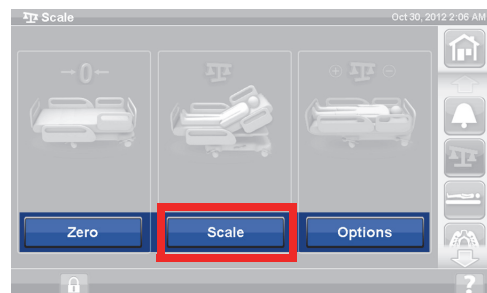

3. Press **Patient Height icon** and enter the patient height.

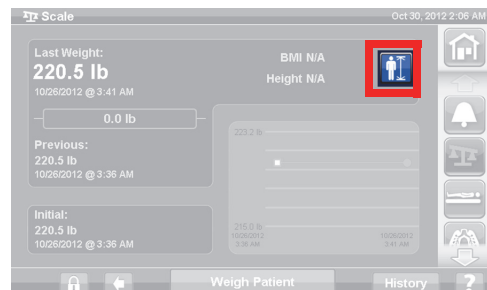

4. Press **Accept**.

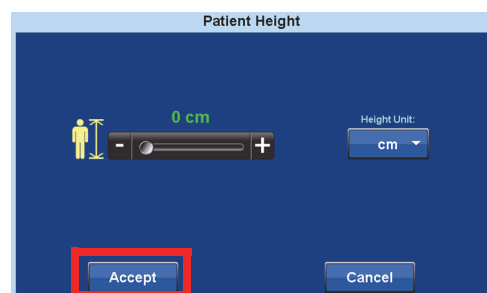

**WARNING:**

Warning—Do not unlock or change the scale units without facility authorization. To do so may cause personal injury.

The option for a caregiver to change the scale units may be not be available for your bed. If you follow the instructions below and the lb/kg units do not change, then you will need to get facility authorization to have maintenance or Hill-Rom change the units.

Change between Lb and Kg, Adjust Weight, or Add/Remove Items

Adjust Weight: Manually enter patient's estimated weight.

Add/ Remove Items: Manually account for items added or removed.

1. Press the **Scale** menu control on the GCI screen.



2. Press **Options**.



3. Press **the desired function**. Follow the on-screen instructions.

- Adjust Weight—manually enter the patient's estimated weight.
- Add/Remove Items—manually change the weight for items added or removed from the bed.
- lb—change weight units (available on some beds)

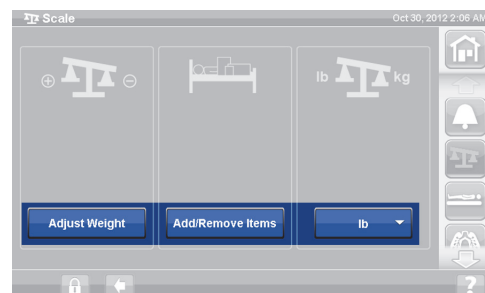

View Weight History

The GCI screen will show the initial weight of the patient and will allow you to view at least 21 weights that were taken. The screen will show the date and time, last zero, the weight, and how much weight was adjusted.

1. Press the **Scale** menu control on the GCI screen.



2. Press **Scale**.

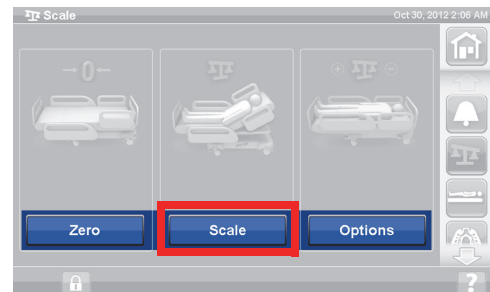

3. Press the **History**.

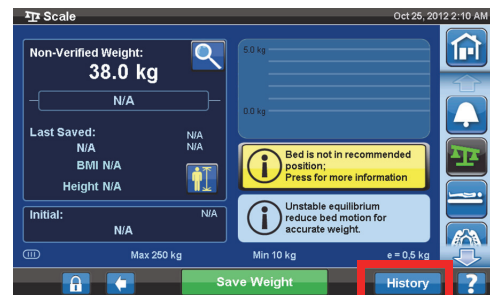

If the weight was taken in a Not Recommended Position, an icon will appear, which shows the status of the bed when the weight was taken.

Use the arrows or touch a dot to see different weights.

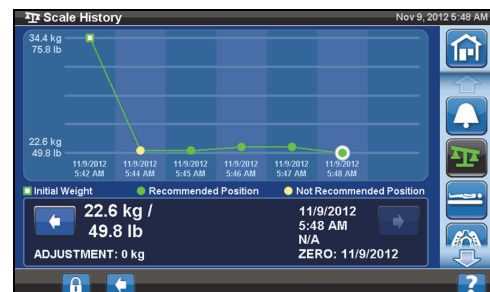

SCALE—NAWI COMPLIANT (EN 45501)



WARNING:

Warning—Incorrect use of the scale can result in inaccurate patient weights, which could result in harm to the patient.

Some beds are equipped with the NAWI Scale. You can tell if your bed is equipped with the NAWI scale by these:

- The "OT" indicator on the left side of the home screen.
- The scale screen shows a magnifying glass icon on the weighing screen. The weight is continuously updating.

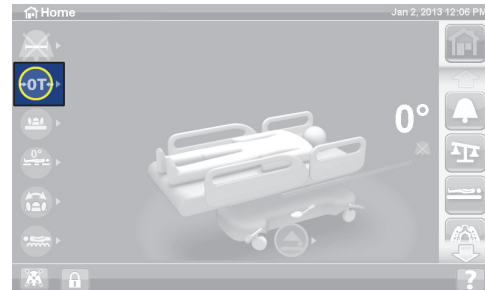

The Scale menu control on the GCI screen allows you to do these:

- Zero the Scale (does not clear history)
- New Patient (clears history and zeroes scale)
- Weigh Patient
- Adjust the weight, add/remove items, calculate BMI, or view weight history



Non-Verified Weight is a live weight reading of the patient and all items on the weighing area that are not zeroed/tared out. To verify weight remove items on the weigh area that are not zeroed/tared and press **Save Weight**.

If the weight reading shows as all dashes, the scale is unable to weigh the patient. This may occur if the bed weight limit has been exceeded, or there is an internal error. Remove the patient from the bed. If this does not fix the problem, contact facility maintenance for further troubleshooting.

If the bed has a pendant installed, make sure it is either on the siderail or footboard when you zero the scale or weigh a patient.

To protect the privacy of the patient, do not leave the patient weight displayed on the screen. Return to the Home screen by pressing the **Home** menu control on the GCI screen.

Unstable Equilibrium

Unstable equilibrium means the equilibrium between internal readings for the scale is not stable. If the Unstable equilibrium indicator is on, scale accuracy will be diminished. This function is automatic and cannot be selected by the caregiver.

2. Press **Scale**.

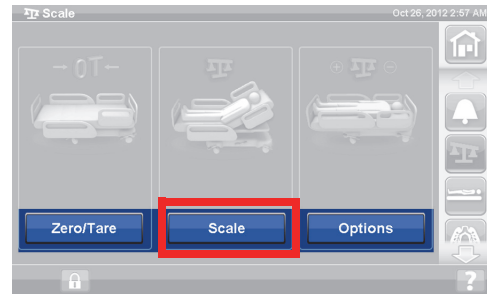

3. Press **History**. Follow the on-screen instructions.



- Press the dots to view more information about previously saved weights.



Zero/Tare the Scale or New Patient

The Zero/Tare function lets the caregiver reset the scale system **before** a new patient uses the bed.

1. Remove equipment and accessories from the bed.
2. Make sure the bed is in the correct position for Zero/Tare. Refer to “Recommended Bed Position to Weigh a Patient and Required Bed Position to Zero/Tare the Bed” on page 40.
3. Press the **Scale** menu control on the GCI home screen.



4. Press **Zero/Tare**.

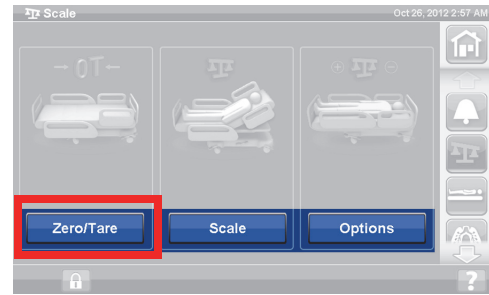

5. Press:

- **New Patient**
 - Erases Scale History (all previously recorded patient weights will be erased)
 - Zeroes the scale
 - Returns the surface to Normal /Normal (CLP) mode
 - Turns off all RemindMe reminders

or

- **Zero/Tare**
 - Does **not** erase Scale History
 - Zeroes/Tares the scale



After the scale is zeroed/tared, and the empty bed is in a stable position, a green indicator with +/- 0,25 e Zero/Tare will appear on the Scale screen. This indicates the bed has an acceptable zero/tare. Once there is weight in the bed this indicator will not show. If there is an unstable equilibrium +/- 0,25 e Zero/Tare indicator will also not show. If the empty bed has been zeroed/tared, is in a stable position, and the indicator is not on, the bed will need to be re-zeroed/tared.

Magnification Mode (Extended Weighing Device)

Only available on the NAWI Compliant (EN 45501) Scale. Pressing the magnifying glass (Magnification Mode (A)) will change the scale display increments to 0.1 kg for 5 seconds. Weights cannot be saved in the Magnification Mode.

- Magnification Mode (A)—changes the scale display increments to 0.1 kg for 5 seconds.
- Bed not in recommended position (B)—shows the recommended bed position for weighing.
- Unstable equilibrium indicator (C)

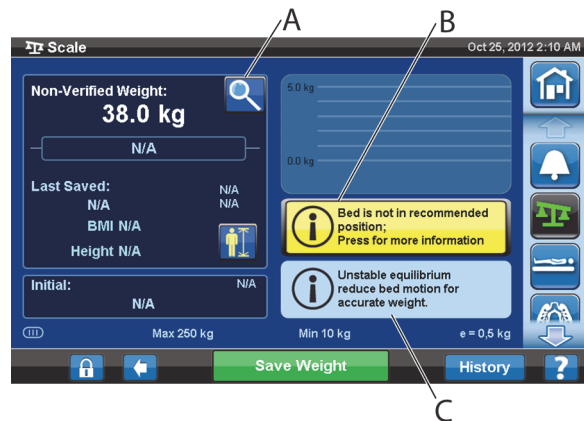

Save Weight

1. Make sure the patient is centered and laying on the bed.
2. Press the **Scale** menu control on the GCI screen.



3. Press **Scale**.

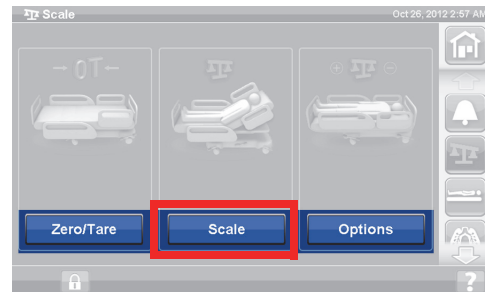

4. Verify the weight by removing items from the weighing area that were not zeroed.
5. Press **Save Weight**. Follow the on-screen instructions.
 - Caregiver has verified and saved the patient weight.

NOTE:

If the Non-Verified Weight has two red dashes and the Save Weight button is grayed out, then re-zero/tare the bed.



Add/Remove Items

Add/Remove Items lets the caregiver change items on the bed and correct the weight reading while the patient is on the bed.

NOTE:

If the patient is **not** on the bed, use the Zero/Tare function after you change the items on the bed.

The Add/Remove Items function keeps the patient's weight in memory as you change items on the bed. Before you add or remove items, use the Add/Remove Items option to keep the weight reading for the items being changed.

1. Press the **Scale** menu control on the GCI home screen.



2. Press **Options**.

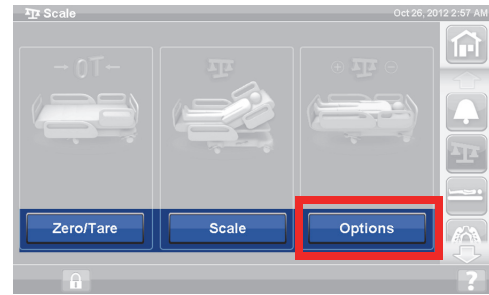

3. Press **Add/Remove Items**. Follow the on-screen instructions.

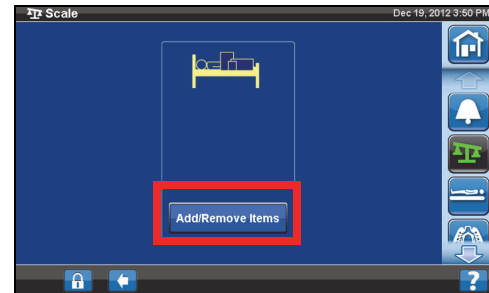

After using the Add/Remove function the word *Net* will appear next to the non-verified weight. *Net* indicates a user has manually changed the non-verified weight. The weight saved after using Add/Remove Items will be noted with the word *Net* next to it. If that same device is later removed or the cumulated adjustment amount is 0 kg, the word *Net* will no longer appear.



Scale Specifications

Class III

$e = 0.5$

Conforms to the European Medical Device Directive 93/42/EEC for a device that has a measuring function. The scale is classified per Scale Directive 2009/23/EC.

Maximum weight: 250 kg

Minimum weight: 10 kg

Display interval: 0.5 kg

Combined zero and tare range: 10 kg to 250 kg

The maximum scale capacity is 250 kg, however the maximum patient weight for the bed is 227 kg.

SETTINGS/PREFERENCES

Through the Settings menu control, you can—

- Reset the bed for a new patient.
- See the history of the scale, bed exit, some bed positions, and surface therapies.
- Set the preferred language to show on the GCI screen.
- Set the time and date.
- Update the software (only for beds equipped with wireless connectivity).
- Turn on or off the WiFi connection.
- View the software version of the bed.

New Patient

The **New Patient** control clears the weight history and Therapy Statistics, re-zeroes the scale, and resets Patient Comfort.

History

1. Press the **Settings** menu control on the GCI home screen.
2. Press **History** to see Bed Exit alert history, Head Angles, Weigh Patient History, Rotation Therapy, Percussion and Vibration Therapy, Chair, and Opti-Rest.
 - A History control is also present in each area of the GCI screen that has history associated with it. For example, the bottom of the Rotation screen.

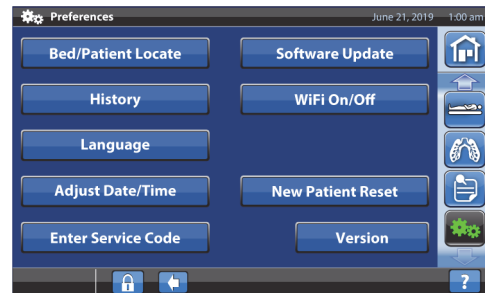

Views

Bed Exit: Displays the time spent with the Bed Exit alert on.

Head Angle: Time spent with the head of bed more than 30° or 45° since 12 AM with Head Angle alert active.

Scale: Displays the saved weights in 24-hour periods.

Rotation: Displays the maximum number of cycles/ hour the patient has rotated and hrs: mins in rotation, in 24 hours periods.

P&V: Displays the number of Percussion and Vibration treatments provided per 24-hour period.

Chair: Time spent in Chair position since 12 AM.

Opti-Rest: Time spent in Opti-Rest mode since 12 AM.

To clear histories, refer to “Zero/New Patient” on page 34 **or** “Zero/Tare the Scale or New Patient” on page 41.

Change the Language

1. Press the **Settings** menu control on the GCI screen.
2. Press **Language** and select the applicable language.
3. Press **Accept**.

Adjust Time and Date

1. Press the **Settings** menu control on the GCI screen.
2. Press the **Adjust Date/Time** button. Follow the on-screen instructions.
3. Press **Accept** when the time and date are correct.

Version

The **Version** control shows the software versions on the bed.

1. Press the **Settings** menu control on the GCI screen.
2. Press **Version**.

Software Update

To receive software update notifications, the bed will need to be connected to the wireless network, see "WiFi On/Off" on page 47.

NOTE:

The software can not be updated with a patient on the bed.

A software update is available for the bed when—

- A purple software update indicator shows on the Settings menu control and the Software Update control.

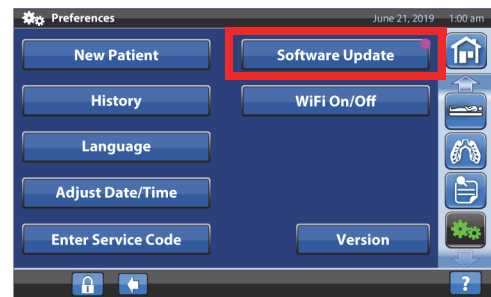

NOTE:

Make sure of these:

- There is not a patient on the bed.
- The wireless is on and connected to the wireless network, see "WiFi On/Off" on page 47.

1. Press the **Settings** menu control.



2. Press **Software Update**.

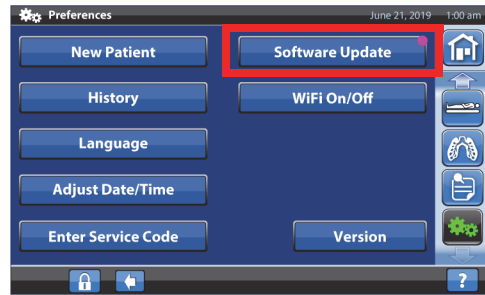

3. The New Bed Software Available screen shows on the GCI screen. Do the following:

- Press **Update Later** to return to the Home screen.

or

- Press **Continue** to continue with the software update.



4. Press **Update Later** to return to the Home screen.

or

Press **Start Update** to begin the software update.



A progress Software Update screen will show.

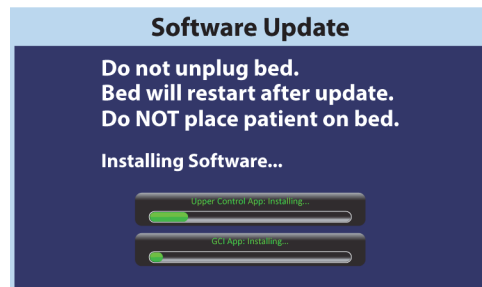

WiFi On/Off

To use the WiFi option, the bed must be connected to a wireless network. Contact your local representative to complete this setup.

1. Press the **Settings** menu control.



2. Press **WiFi On/Off**.

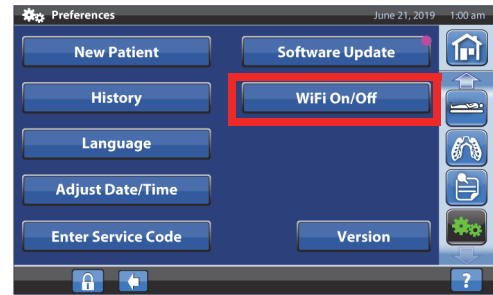

3. Press **On** or **Off**.

4. Press **Back** to return to the Home screen.



BED FRAME FEATURES

This section describes general features found on the bed. Not all features listed are present on all beds.

POINT-OF-CARE BRAKE AND STEER SYSTEM



WARNING:

Warning—To help prevent injury and/or equipment damage, obey these **warnings**:

- **Warning**—Unless transporting the patient, always set the brakes. Make sure the brakes are set before and after any patient transport. Failure to do so may cause injury or equipment damage.
- **Warning**—Always set the brakes when the bed is occupied, except during patient transport. To help make sure the bed will not move, push and pull on the bed to check it after the brakes are engaged.
- **Warning**—Brakes should always be set when the bed is occupied and especially when moving a patient from one surface to another. Patients often use the bed for support when getting out of bed and could be injured if the bed unexpectedly moves. After setting the brakes, push and pull the bed to make sure of stability. Failure to do so could cause injury or equipment damage.



The **Point-of-Care** Brake and Steer System pedals are located: above the foot-end casters (brake), the sides of the bed (steer), and at the head-end of the bed (brake and steer). At the head-end of the bed, the brake pedal is on the left, and the steer pedal is on the right.

- Use the steer mode to help move the bed in a straight line and maneuver through hallways.
- Use the brake feature to keep the bed from moving.
- Use the neutral position to move the bed sideways in a room or small enclosed area.

There are three steer systems available on the bed: Corner Steer, 5th Wheel, and **IntelliDrive** Transport System.

To Activate



 <p>Steer Neutral BRAKE</p>		 <p>Brake Neutral STEER</p>
<p>Brake (orange pedal)— Step down on the orange brake pedal until it stops. Push and pull on the bed to make sure that the brake function is fully engaged.</p>	<p>Neutral Position—Move the brake or steer pedal to the level position. The bed can now be moved in any direction.</p>	<p>Steer (green pedal)— Step down on the green steer pedal until it stops. The left foot-end caster locks in-line.</p>

Corner Steer: The left foot-end caster locks in-line ready for system movements.

5th Wheel: When the brake and steer pedal is placed in steer, the front casters are not locked into steer mode. All four casters on the bed are put into the neutral position. This allows the bed to pivot on the 5th wheel. Pivoting on the 5th wheel, allows for tighter turns, and enhanced ease of steering.

IntelliDrive Transport System: Steer mechanism operates as above in 5th wheel only with a power drive wheel.

When the bed is connected to AC power and the brakes are not set, an alert sounds and a message shows on the GCI screen. When AC power is removed, the alert will stop and the GCI screen will turn off.

HEADBOARD

The headboard is attached to the head end of the frame, and it goes up and down with the frame.

The headboard can be removed for increased access to the patient's head.

A caregiver can quickly remove or attach the headboard in a single step without the use of tools.

To Remove

To remove, grasp the headboard and lift straight up.

Install

Position the headboard sockets, indicated by arrows on the back of the headboard, over the pins on the frame. Then lower the headboard onto the pins. Push the headboard down until the bottom rests on the frame.



FOOTBOARD

The footboard attaches to the articulating foot section, and it remains perpendicular to the surface of the foot section at all times. The footboard protects the patient during transport and room docking.

A caregiver can quickly remove or attach the footboard in a single step without the use of tools. When removed the footboard is designed to stand upright.



WARNING:

Warning—Do not stand or sit on the footboard. Injury or equipment damage could occur.

To Remove/Install:

- To remove, grasp the handles on the footboard and lift straight up.
- To install, insert the pins of the footboard in the articulating frame. Push the footboard down until it rests on the deck.



WARNING:

Warning—When the footboard is removed from the bed, do not lay the footboard flat on the floor. Store the footboard in a position or location so that it does not come in contact with biohazards. Failure to do so could cause injury.

NOTE:

If the footboard does **not** have a transport shelf installed, the footboard can be set upright on the floor. If a transport shelf is installed, the footboard can be put against a wall in a position so that it will not fall.



TRANSPORT

NOTE:

Do not walk in front of the bed during transport. Guide the bed from the sides or by the transport handles.

Transport Handles

Transport handles are provided at the head end of the bed. The handles provide the caregiver easy-to-grasp grips for steering and positioning the bed.

To Use:

1. Raise the handles from the stowed position.
2. Lower the handles into the bed frame.

To Stow:

1. Pull the handles upward from the bed frame.
2. Lower the handles inward toward the center of the bed until they stop moving.



CAUTION:

Caution—Do not push or pull the bed by IV poles or other equipment. Use the transport handles or footboard. Failure to do so can cause equipment damage.

Transport Position



WARNING:

Warning—To help prevent injury and/or equipment damage, obey these **warnings**:

- **Warning**—Do not transport a patient with the bed in a **FullChair** position, **Chair Egress** position, or **Dining Chair** position.
- **Warning**—Do not push or pull the bed by the IV poles.
- **Warning**—If applicable, put the caregiver pendant on the patient side of the footboard or the patient side of the intermediate siderail when the bed is in transport, see below.
- **Warning**—Before you move the bed, make sure the communication cable is unplugged and stored correctly.



- **Warning**—If applicable, remove the proning accessory.
- **Warning**—If applicable, put the **Experience Pod** Device in the transport position as shown and the device can clear doorways.

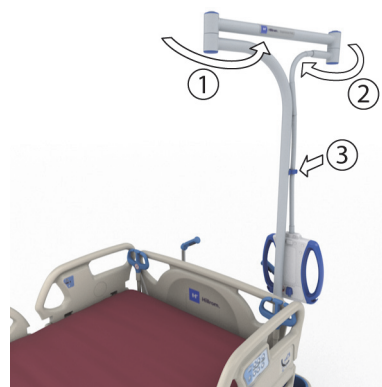

CAUTION:

Caution—Use caution when you move the bed through doorways. Equipment damage could occur.

The bed is intended to be used to transport patients with the foot end of the bed forward. Prior to transport, properly store the power cords to prevent tripping. Use the power cord storage hook at the head-end of the bed. Take care to prevent damage to AC power cords. An electrical shock hazard exists. Use only transport handles or the footboard to move the bed.

Transport the Bed

1. Raise the bed so the transport handles are at a comfortable height.
2. Make sure of these (if applicable):
 - The head section is low enough to have clear view of the travel path.
 - The patient, equipment, and all lines are securely placed within the perimeter of the bed.
 - Lower IV poles as applicable so they do not impact doorways or ceiling fixtures.
 - Remove the proning accessory.
 - Put the **Experience Pod** Device in the transport position as shown and the device can clear doorways.

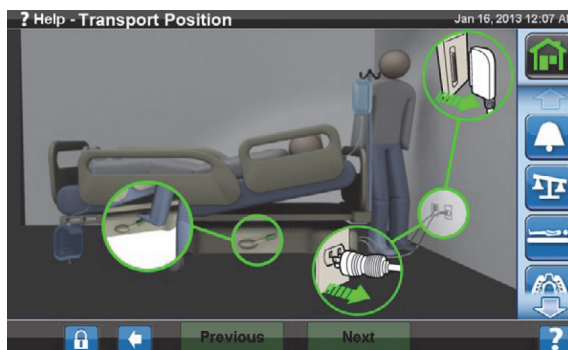

3. Unplug and stow the AC power cord, accessory outlet power cord, and communication cable on the storage hook at the head-end of the bed.
4. Put the bed in Steer (step down on the green pedal until it stops) or Neutral position.
5. Make sure the casters are in the trailing position.
6. Use the transport handles or **IntelliDrive** Transport System to move the bed.

**WARNING:**

Warning—A single person can transport the bed. To help prevent injury or equipment damage, additional people may be needed for transport if the bed does not have the **IntelliDrive** Transport System during these conditions:

- High weight is on the bed—greater than 250 lb (113 kg)
- Casters are not aligned with the direction of travel

NOTE:

Additional people may also be needed for transport if the bed does not have the **IntelliDrive** Transport System during these conditions:

- Floor is not level—inclines, declines, or lateral tilt
- Floor obstructions—thresholds, floor transitions, or gaps
- Floor is not hard—carpeting

**WARNING:**

Warning—During transport, use caution so the bed does not tip or overbalance. Failure to do so may cause injury or equipment damage.

Generally, as the load increases, the risk of instability goes up.

Lower the bed height to increase stability.

Use and position of accessories may affect stability. Do not overextend IV poles or similar accessories and do not overload accessories. If multiple accessories are in use, distribute them evenly from side to side or head to foot.

For inclines or thresholds, approach them as you move forward or backwards, rather than sideways.

To help prevent overbalance or collision with hidden objects or people, do not make sharp turns at corners and do not turn the bed at high speeds.

After Transport

- Put the bed in the intended location.
- Set the brakes.
- Stow the transport handles or **IntelliDrive** Transport System handles.
- Connect the AC power cord, accessory outlet power cord, and communication cable (as applicable).
- Return IV poles to correct working height.

IntelliDrive Transport System (Power Transport)

The **IntelliDrive** Transport System is a permanently attached powered drive mechanism built into the bed. This mechanism deploys or stows as a function of the position of the brake/steer pedal and AC power availability. It is activated by applying pressure to the transport handles located at the head end of the bed. This allows the caregiver to propel the **Progressa** Bed during patient transport with minimal applied force. The label between the handles and on the bed frame shows the battery charge and the correct way to use the system.

To Use the IntelliDrive Transport System

1. Raise all four siderails to the up and locked position.
2. Raise the bed so the transport handles are at a comfortable height.
3. Make sure of these (if applicable):
 - The head section is low enough to have clear view of the travel path.
 - The patient, equipment (monitors, oxygen tanks, IV poles, or any other equipment), and all lines are securely placed within the perimeter of the bed.
 - Lower IV poles as applicable so they do not impact doorways or ceiling fixtures.
 - Remove the proning accessory.
 - Put the **Experience Pod** Device in the transport position as shown and the device can clear doorways.



4. Make sure the transport handles are up and locked in position.
5. Unplug the bed from its power source.
6. Unplug and stow all power cords and communication cords on the hook at the bottom of the transport handle.
7. Set the steer pedal to *Steer* (step down on the green brake pedal until it stops).

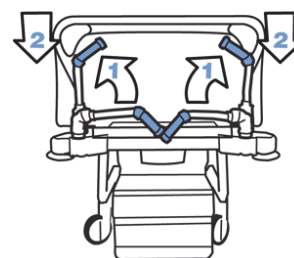

NOTE:

Unplugging the bed, and putting the bed in steer mode will automatically deploy the drive wheel, but will **not** power the **IntelliDrive** Transport System.

Sequence label—located between the transport handles.

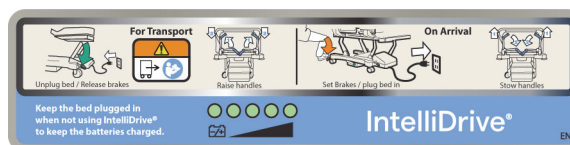

8. Grip one or both of the transport handles located at the head end of the bed.

9. Press at least one of the enable switches on the **underside of the blue transport handles**.

- Pressing an enable switch engages the drive wheel on the bed so it can move when pressure is applied to the handles.
- Pressing an enable switch will not cause the bed to start moving if there is no pressure applied to the handles.

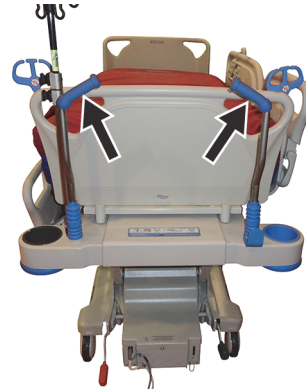

10. Push the transport handles forward to start forward movement or pull them toward you to start reverse movement. There may be a momentary delay before the bed moves.

- Pressure sensors located in the transport handles sense the applied pressure, activate the motor, and propel the bed in the direction of applied pressure.
- The amount of applied pressure to the handles will regulate the speed of the bed.
 - Increasing the forward applied pressure will move the bed forward faster. Maximum forward speed is between 2.5 and 3.5 mph (4.0 and 5.6 kph) on level flooring.
 - Increasing the reverse applied pressure will move the bed in reverse faster. Maximum reverse speed is between 1.0 and 2.0 mph (1.6 and 3.2 kph) on level flooring.
 - Decreasing pressure on the transport handles will slow the bed down.
 - Releasing the enable switch(es) on the transport handles will cause the bed to stop.

To Deactivate the IntelliDrive Transport System

1. Set the brake/steer system to neutral or brake, **or**
2. Plug the bed into an appropriate power source.

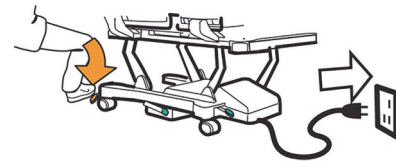

To Store the Transport Handles

1. Grasp the handles, and lift upwards to unlock the handles.
2. Swing the handles inward toward the center of the bed into the stowed position.

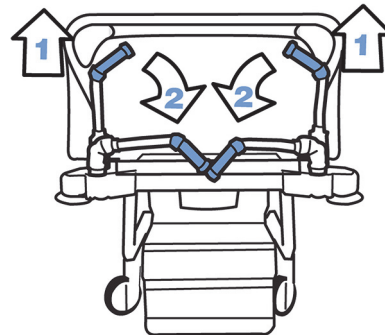

In case of battery or motor power loss, press the electronic brake switch (on the drive box on the bottom of the bed) to permit forward and reverse bed movement with a deployed, unpowered, **IntelliDrive** Transport System.

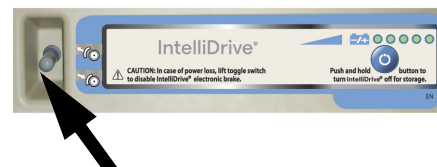



WARNING:

Warning—To help prevent injury and/or equipment damage, obey these **warnings**:

- **Warning**—If the bed propels forward or reverse when depressing one of the enable switches and not applying any pressure on either of the handles, contact your local service personnel for repair.
- **Warning**—If the bed propels forward or reverse while applying pressure on either of the transport handles and not pressing either of the enable switches, contact your local service personnel for repair.
- **Warning**—If the bed is stopped on a ramp, or a patient is left unattended, set the brake to avoid unwanted bed movement.
- **Warning**—Significantly reduce the speed of travel when powering the **IntelliDrive** Transport System when using freestanding patient attached equipment or traveling through doorways.



CAUTION:

Caution—The **IntelliDrive** Transport System is intended for indoor use only. Outdoor use may cause temporary or permanent damage to the powered drive mechanism and/or drive belt.

WALLGUARD BUMPER SYSTEM

The WallGuard Bumper System protects the perimeter of the **Progressa** Bed when it is being moved or transported.

Roller bumpers protect the walls and doorways when transporting the bed.

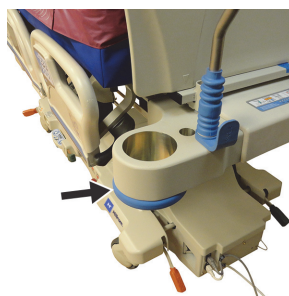

Head End



Foot End

LINE MANAGER (P7512)

A Line Manager is on each side of the head end of the bed. The Line Manager helps to keep lines (such as IV lines, suction lines, etc.) together and away from the articulating frame. The flexibility of the Line Manager lets you bend it in any direction.



WARNING:

Warning—Make sure the lines are not pinched or kinked and there is sufficient slack in the lines for bed articulations and patient movement. Failure to do so could cause injury or equipment damage.



CAUTION:

Caution—Do not wrap the power cord or communication cable around the line manager. Equipment damage could occur.

DRAINAGE BAG HOLDERS



WARNING:

Warning—To help prevent injury and/or equipment damage, obey these warnings:

- **Warning**—Remove drainage bags from the foot section before you use the Chair control and remove drainage bags from siderails before transport.
- **Warning**—Use caution when you position the drainage bag tubing to keep it away from moving parts.
- **Warning**—Lowering the bed may cause drainage bags to come in contact with the floor. Follow facility protocol if they touch the floor.
- **Warning**—Use caution when you raise or lower a siderail with a drainage bag present.
- **Warning**—Hanging a drainage bag on any part of the bed other than the drainage hooks, without making sure proper drainage can be achieved, may result in patient injury.
- **Warning**—Remove any drainage bags from the siderails for transport.

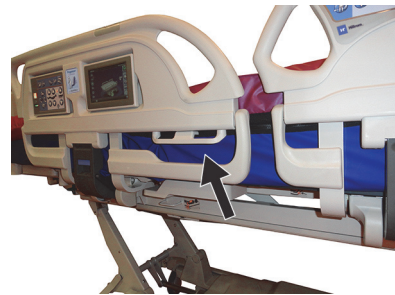

CAUTION:

Caution—When you use the foot section articulations (up/down, retract/extend) or Trendelenburg or Reverse Trendelenburg controls, make sure the drainage bags do not touch the floor.

The bed is equipped with six drainage bag holders on each side of the bed.

Holders on the weigh frame include three (3) holders on each side of the foot section and two (2) hangers on each intermediate siderail.

There is one (1) green hanger on each side of the bed that is not on the weigh frame. Only the green drainage holders near the foot section will not be part of patient weighing.

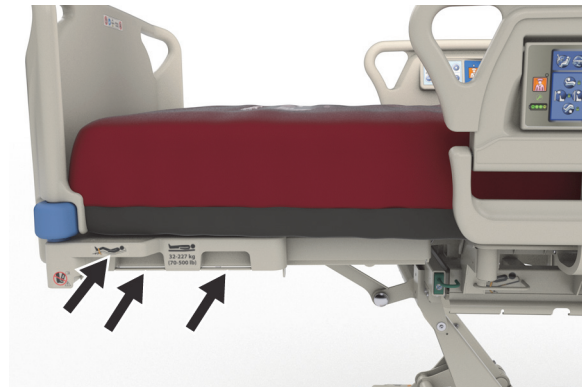

The holders accommodate any combination of the following drainage devices:

- Fecal incontinence bag
- 250-2000 ml Foley collection bag
- Chest drainage devices on the tan siderail holders or on the foot-end holders not in the lowest bed height.

When the bed is docked, follow facility protocol for placement of the chest drainage devices.

The primary drainage bag holders are located on the weigh frame. The green hook under the foot section is not on the weigh frame and should be used to keep drainage bags off the floor when you weigh a patient.

RESTRAINTS



WARNING:

Warning—To help prevent injury and/or equipment damage, obey these **warnings**:

- **Warning**—Patient restraints are not intended as substitutes for good nursing practices. Physical restraints, even properly installed, can cause entanglement, physical injury, and death, particularly with agitated and disoriented patients. Monitor patients when using physical restraints in accordance with legal requirements and facility protocol.
- **Warning**—Restraints must be attached to proper attachment points, not the siderails.
- **Warning**—Follow the restraint manufacturer's instructions.
- **Warning**—For restraining devices, consult the restraint manufacturer's instructions for use to verify the correct application of each restraining device.
- **Warning**—Never use ankle restraints in a chair position or when the foot section is retracted. Do not use the foot up/ down or foot extend/retract controls as these will change the **FlexAfoot** Feature length.
- **Warning**—Never use ankle restraints in a chair position or when the foot section is retracted.

The bed facilitates the use of vest, wrist, waist, and ankle restraints. Hill-Rom makes no recommendation regarding the use of physical restraints. Users should refer to legal restrictions and appropriate facility protocols before physical restraints are used. Ankle restraints can be tied to the designated ankle restraint holders and also to the drainage bag holders on the foot section of the bed.

- Vest (A)—slot in the head section (under the surface).
- Wrist/Vest (B)—Metal bar near the middle of the upper frame.
- Wrist (C)—Metal bar on the upper frame under knee section.
- Ankle (D)—Corner of the foot section.

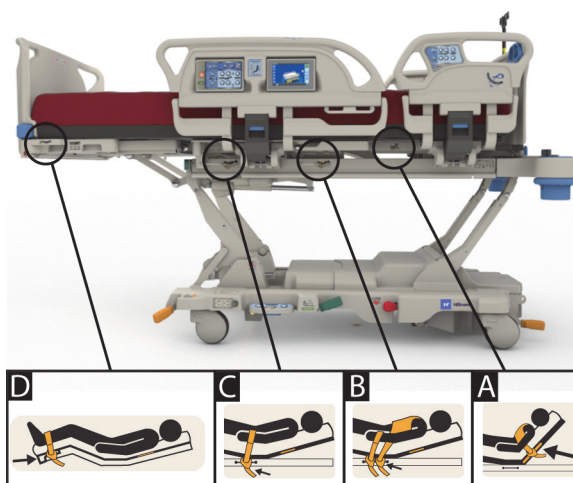

FLUOROSCOPY/C-ARM



WARNING:

Warning—To help prevent injury and/or equipment damage, obey these **warnings**:

- **Warning**—Use of surface radiolucency in areas with identified artifacts is not intended for diagnosis of underlying pathology. Intended use in the identified artifact areas, for example, includes tracking location of a radio-opaque component of a vascular central line.
- **Warning**—Hill-Rom does not indicate the use of the **Progressa** Bed with any particular portable CT scanner. Contact the portable CT scanner manufacturer to make sure of the compatibility with the bed and patient stability.

The bed provides a radiolucent head section that measures 17.7" x 23" (43 cm x 58 cm). The radiolucent head section allows a caregiver to perform fluoroscopy of patients from head to waist when the patient is lying flat.

Bed Setup when You Use a C-Arm

1. Set the brakes.
2. Lockout all articulation controls before you position the patient in the mobile scanner.

Below shows the surface artifacts that were found.

Progressa Therapy and Pulmonary Surface (P7520A) Artifact Locations

(artifacts can include metal coil, non-metal tubing, and fittings)

Head End

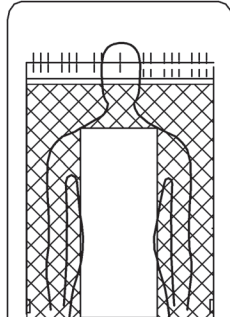

Artifact locations

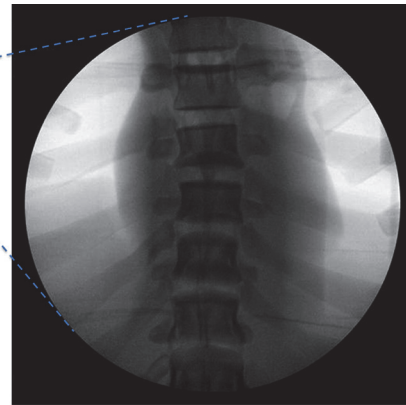
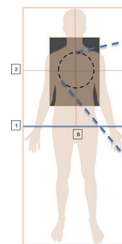

Progressa Pulmonary surface shown

Prevention/Essential Surface Artifact Locations

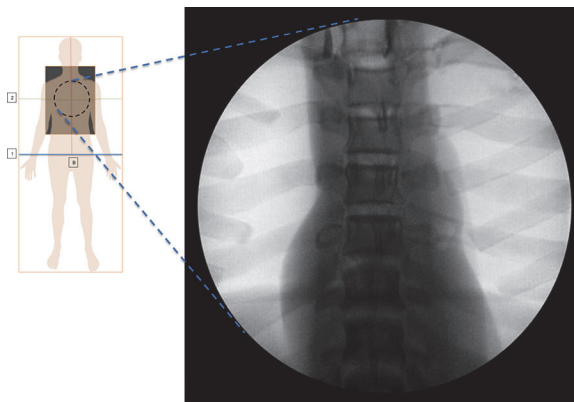

Progressa Prevention/Essential surface shown

Progressa Advance and Accelerate Surfaces (P7540A) Artifact Locations

(artifacts can include metal coil, non-metal tubing, fittings, non-metal fastener components, and mesh materials)

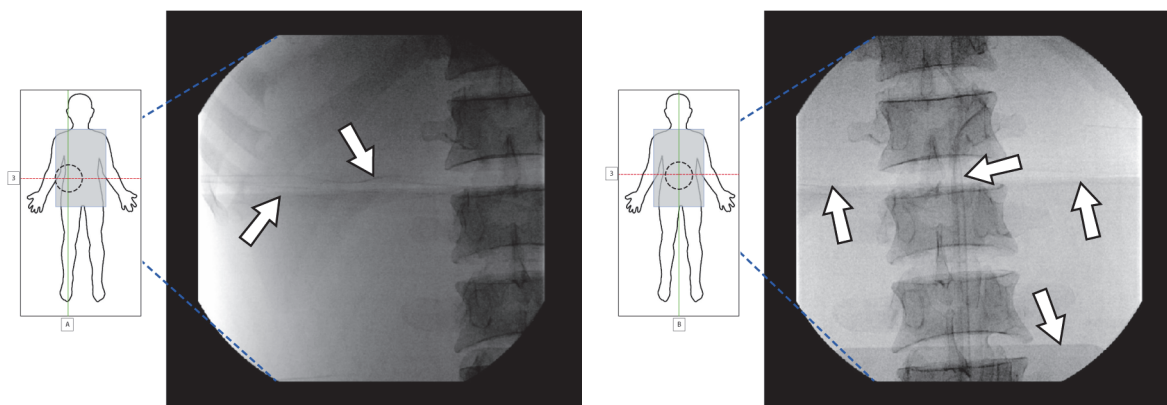

Progressa Accelerate surface shown

X-RAY SLEEVE

The x-ray sleeve is available on powered air surfaces. It is located under the patient's chest area. To determine if your surface has an x-ray sleeve, see below.



P7520A Model Surface

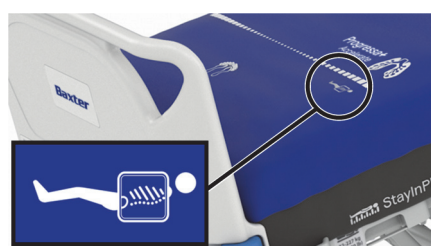

P7540A Model Surface

To use the sleeve, do as follows:

1. Make sure the brake is set on the bed.
2. Make sure the head of the bed is at least 30°. The position may be adjusted for patient comfort.
3. Put the mattress in the Max-Inflate/P-Max Inflate mode:
 - a. Press the **Surface** menu control on the GCI screen.
 - b. Press **Max-Inflate/P-Max** Inflate.
4. Pull the sheet away from the edge of the mattress.
5. Lift the flap over the zipper.
6. Unzip the sleeve. Use caution when operating the zipper. If the zipper binds, do not continue to pull.
7. Make sure the x-ray cassette is in a pillow case or similar covering.
8. Insert the x-ray cassette.
9. Remove the x-ray cassette when finished.
10. Close and zip the sleeve.



NOTE:

The cassette should insert easily. If it does not, take action to further offload patient weight. This may generally be accomplished by raising the head of bed angle further, requesting the patient to lean forward, or obtaining the assistance of a second person, as appropriate for the clinical situation.

EQUIPMENT SOCKETS

Equipment sockets are provided at each corner of the deck for equipment such as IV poles and infusion support.



CAUTION:

Caution—To help prevent equipment damage, obey these **cautions**:

- **Caution**—The equipment sockets are not to be used for overhead fracture frame equipment.
- **Caution**—Before moving the bed into any of the chair positions, remove all equipment from the sockets at the foot end of the articulating deck.
- **Caution**—While articulating into a Trendelenburg position, make sure there is adequate headwall clearance.



IV POLE SOCKETS

The **Progressa** Bed comes with four standard IV sockets. Two are located at the head end and two are located behind the footboard at the corners of the foot end.



WARNING:

Warning—To help prevent injury and/or equipment damage, obey these **warnings**:

- **Warning**—Remove all equipment from the foot-end equipment sockets before you put the bed in the chair position.
- **Warning**—Make sure there is sufficient room at the head-end of the bed for equipment in the sockets when you raise the bed or go in to the Trendelenburg/Reverse Trendelenburg positions.



Head End

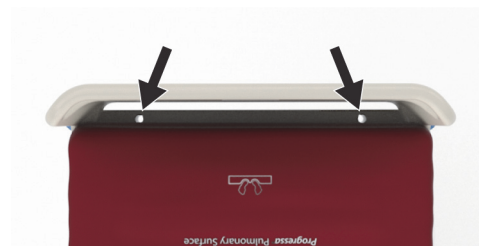

Foot End

FRACTURE FRAME SOCKETS



WARNING:

Warning—To help prevent injury and/or equipment damage, obey these **warnings**:

- **Warning**—Caregiver to evaluate patients for entrapment and asphyxiation when using traction equipment.
- **Warning**—Follow facility protocol for lockouts of bed controls when traction equipment is installed.

There are four locations for the traction equipment to install—two at the head end, and one on each side of the bed near the thigh section. Make sure to use the appropriate adapter for the traction equipment according to the manufacturer's instructions.



Head End



Side View

PERMANENT IV POLE OPTION



WARNING:

Warning—Keep hands away from the connection between the sliding parts when raising and lowering the movable portion of the IV pole or injury could occur.



CAUTION:

Caution—To help prevent equipment damage, obey these **cautions**:

- **Caution**—Permanent IV Pole safe working load is 40 lb (18.1 kg); do not exceed the safe working load.
- **Caution**—Do not mount infusion pumps on the lower section of an IV pole. Interference with head section articulation could result.

The Permanent IV Pole option consists of one IV pole that supports up to two IV pumps plus bags. The IV pole is attached to the frame near one of the corners of the headboard.

Up to 40 lb (18.1 kg) of total weight can be supported per pole.

A permanent IV pole will use one of the removable IV pole sockets on the head-end of the bed.



To Raise

1. Lift the IV pole from its stored position from behind the headboard.
2. Make sure that the pole drops and locks into position.
3. Hold the bottom section.
4. Raise the middle and upper sections of the pole until they click and lock into place. The pole is ready for use.

To Store

1. Grasp and hold the upper section of the pole. Pull the knob out and lower the upper pole section.
2. Lift the lower section of the pole up and rotate the pole down to the stored position between the transport handles and the headboard. The poles should rest in the storage slots provided on the frame.

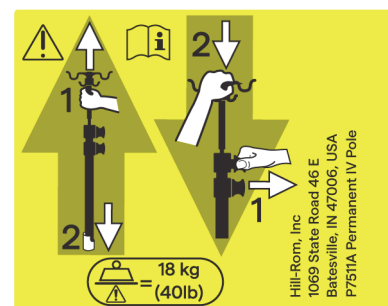

AUXILIARY AC RECEPTACLE OPTION



WARNING:

Warning—To help prevent injury and/or equipment damage, obey these **warnings**:

- **Warning**—Do not use the receptacle for life support equipment. There is no battery back-up. Plug life support equipment directly into facility power supply.
- **Warning**—Do not use oxygen enriched sources near the accessory outlet.
- **Warning**—Do not plug both power cords into the same wall receptacle. Plug the power cords into different receptacles on separate circuits. Failure to do so can cause equipment damage or tripping of facility power breakers.
- **Warning**—Before you move the bed, make sure both power cords are unplugged and stored correctly. Do not wrap the cords between the intermediate and upper frames.

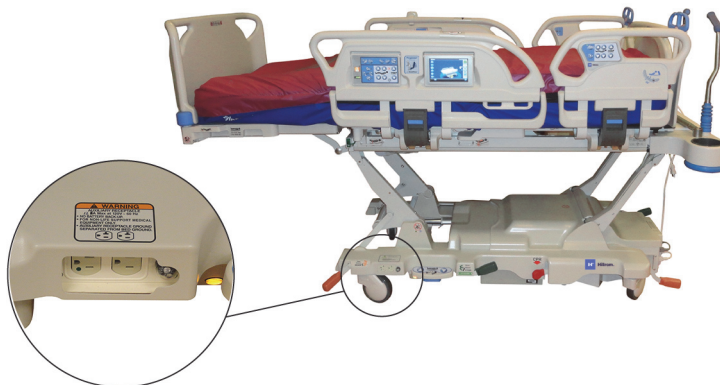

CAUTION:

Caution—Failure to store the accessory power cord when not in use, could cause damage from bed articulation.

The receptacle option is a convenient source of AC power for accessory devices. **The receptacle is not intended for life support equipment.** It is located at the foot end of the base frame.

The receptacle power cord is white, and the bed power cable is gray.

The receptacle provides up to 12 A of AC current (100 to 137 VAC beds) **or** 6 A of AC current (220 to 240 VAC beds). Beds that have this option are equipped with two power cords, one for the accessory receptacle and one for the bed. The receptacle is isolated from the bed's AC power supply.

COMPOSER COMMUNICATION SYSTEM

The **Progressa** Bed is compatible with the COMposer Communication System. With the COMposer Communication System, the bed can be monitored for the following functions:

- Bed in Low position
- Siderail(s) up or down
- Brake set
- Bed exit on or off

VOALTE NURSE CALL SYSTEM

The **Voalte** Nurse Call System is an enterprise system that connects and monitors Baxter and Hill-Rom beds and surfaces. The system sends bed and surface data to network applications for caregivers to view and receive alerts. For complete operational instructions for the **Voalte** Nurse Call System refer to the **Voalte** Nurse Call System User Manual.

WIRELESS CONNECTIVITY



WARNING:

Warning—The wireless module **does not** communicate nurse call information. The bed's **SideCom** Communication System cable must be connected to the facility network for remote nurse call communications. Failure to connect the **SideCom** Communication System cable may result in delay of critical care to the patient.

The Wireless Connectivity module is **not** intended as a replacement for your wired Nurse Call connection.

NOTE:

This module does **not** provide wireless use of environmental controls such as audio or room lighting.

The module operates only when the bed is connected to AC power; it does **not** operate on battery power.

This module is compliant with 2014/53/EU—Radio Equipment Directive (RED).

There are two different wireless modules, an external wireless module or an internal wireless module. The two modules support different features, see “Module Location Option” on page 65 to determine which wireless module you have, if applicable.

Module Location Option

External Wireless Module—To determine if the bed has the external wireless module, raise the head of the bed and look for the wireless box is located on the bed frame.

Internal Wireless Module—To determine if the bed has the internal wireless module installed, look at the left foot-end lift arm. If there is a wireless antenna mounted on the left foot-end lift arm, the bed has the internal wireless module installed.

External Wireless Module



Internal Wireless Module

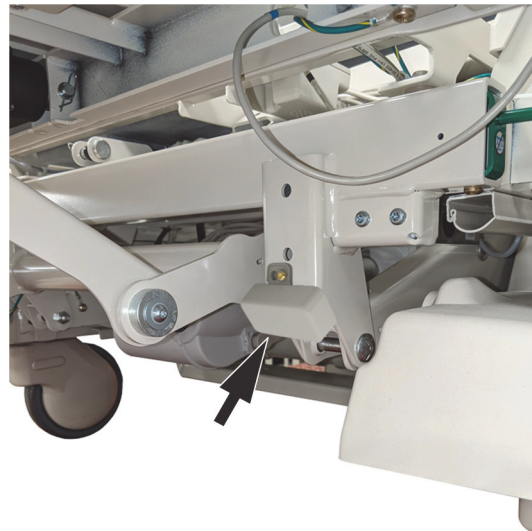

Go to the applicable section for your wireless module:

- “External Wireless Module” on page 66
- “Internal Wireless Module” on page 69

GCI Indicators

NOTE:

The internal and external wireless modules both show the wireless status on the GCI screen. The external wireless module will also show the wireless status on the module.

When you plug the bed into AC power, the color of the Wireless Status indicator on the GCI screen will identify the wireless connectivity status. The Bed Location will also show for beds with the external wireless module.

Wireless Status

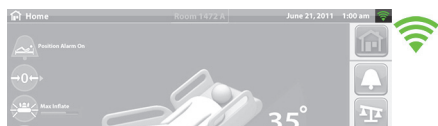

- **No indicator**—the wireless module is not operating correctly or it is not receiving power.



- **White outline**—the wireless module is operating correctly, but it is not connected to the wireless network or it has not been configured.

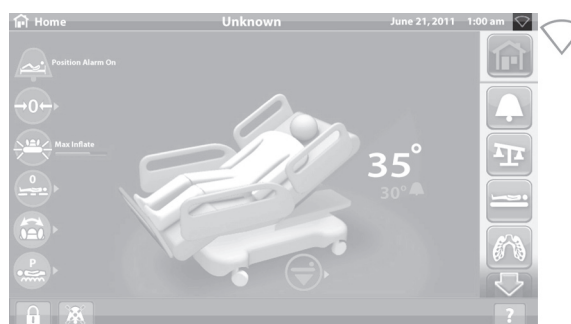

- **Green bars**—the wireless module is operating correctly and is connected the wireless network.



External Wireless Module

The external wireless module permits bed and surface data to be sent to a hospital's information system without a communication cable; the module **does not** communicate nurse call information. The module has a Location feature that identifies the location of the bed when it is in a facility that has a real-time location system (RTLS) installed. The data is sent through Hill-Rom's middleware solution, SmartSync System, to the hospital's information system. (For electrical specifications, see page 121.)

Some beds are equipped with an external wireless module, see below. The content below applies to the external wireless module. For beds with an internal wireless module, see “Wireless Connectivity Specifications—External Wireless Module” on page 121.

External Module Indicators

When you plug the bed into AC power, the module’s three indicators—**Wireless**, **Connected**, and **Location**—will all flash **red**, **green**, and **off** for two cycles (this may take up to 30 seconds to occur). This lets you know that the initialization process has started. The module first connects to the facility’s wireless network, then to SmartSync System, and then to the RTL5. When the initialization process is complete, each indicator will either be green or red depending on its connection status (see the table below). The indicators will stay on until AC power is disconnected or an issue occurs with the module or its connections.

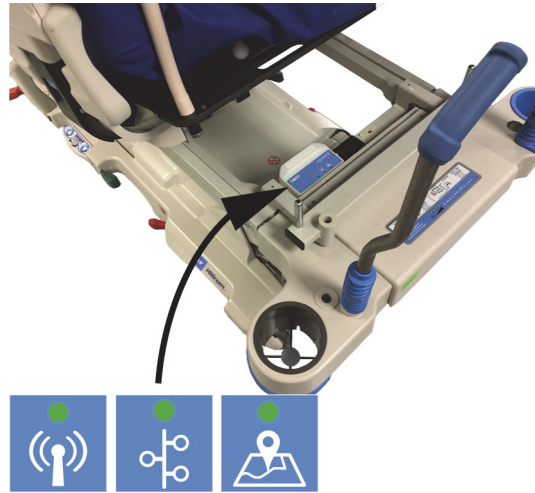



NOTE:

It may take up to 3 minutes for the initialization process to complete. During most of this time, the indicators will be off.

If the bed is receiving AC power, the initialization process is complete (at least 3 minutes have passed since power was connected), and any of the indicators are **red**, there is a network connection issue. If any of the indicators are **off**, there is a software issue. If either of these conditions occur, contact your IT or Service department.

The table below identifies the different states of the indicators:

			Status
Flash red, green, and off	Flash red, green, and off	Flash red, green, and off	The module is initializing.
Off	Off	Off	The module either is not receiving AC power, is initializing, or is in an error condition.
Red	Red	Red	The module is not connected to the wireless network.
Green	Red	Red	The module is connected to the wireless network, but is not communicating with SmartSync System and can not identify the bed’s location.
Green	Green	Red	The module is connected to the wireless network and is communicating with SmartSync System, but can not identify the bed’s location.
Green	Green	Green	The module is connected to the wireless network, is communicating with SmartSync System, and can identify the bed’s location.

Bed Location



- **No location text**—the wireless module is not operating correctly or it is not receiving power.



- **White "Unknown" text**—the wireless module is operating correctly, but it has not received a location or, it has not been configured.



- **Green location text**—the wireless module is operating correctly, and the bed's location has been received.

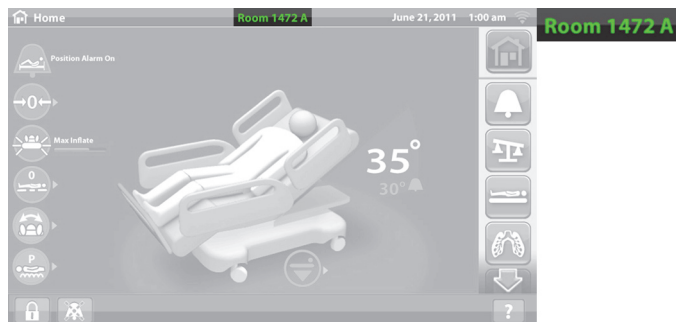

LOCATION ASSET TAG

**CAUTION:**

Caution—To help prevent equipment damage, obey these **cautions**:

- **Caution**—The Wireless Connectivity feature is configured for the Hill-Rom approved Location Asset tag. The location feature may not operate correctly if you use a different asset tag. Contact your local Hill-Rom representative for more information.
- **Caution**—Do not have other wireless devices within 8" (20 cm) of the Location Asset Tag. If their locations are too close, the devices may not operate.



If installed, this tag is used along with the external wireless module option to identify the bed's location (refer to "Wireless Connectivity" on page 65).

For more information about the Location Asset Tag, refer to the manufacturer's instructions included with the tag.

Internal Wireless Module

The internal wireless module permits bed and surface data to be sent to a hospital's information system without a communication cable; the module does not communicate nurse call information or bed location. (For electrical specifications, see page 125.)

SMARTCARE REMOTE MANAGEMENT

The SmartCare Remote Management is a secure cloud-based portal for centralized remote management of Hillrom beds and devices. The SmartCare Remote Management gives the Biomedical Engineers and/or Hillrom Service Technicians access to manage devices remotely for the following features:

- Remote update configuration
- Remote upgrade asset firmware
- Remote asset location tracking
- Remote error code notification

OBSTACLE DETECT SYSTEM

The **Progressa** Bed is equipped with the **Obstacle Detect** System that runs along the two sides of the base frame. On the sides, this system senses objects that are between the upper frame and the base frame.

If the system senses pressure on the sides of the base the Bed Not Down indicator on the siderails will flash.



If you try to lower the bed:

A message on the GCI screen will show the location of the obstruction as left or right and you will not be able to lower the sleep deck.

If the bed is in motion and it encounters an obstacle:

The bed will stop lowering, and then raise automatically for 2 seconds. The GCI screen will show the location of the obstruction as left or right side of the bed.

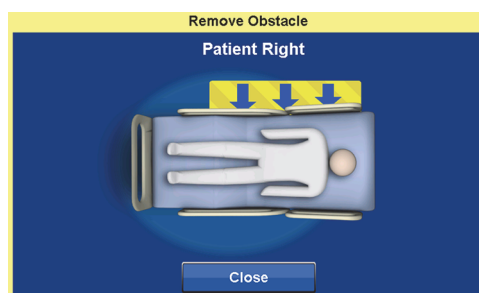

BED UP/DOWN—FOOT CONTROLS

The bed height foot controls are located on both sides of the base frame, near the foot-end casters. This feature times out after 15 seconds.

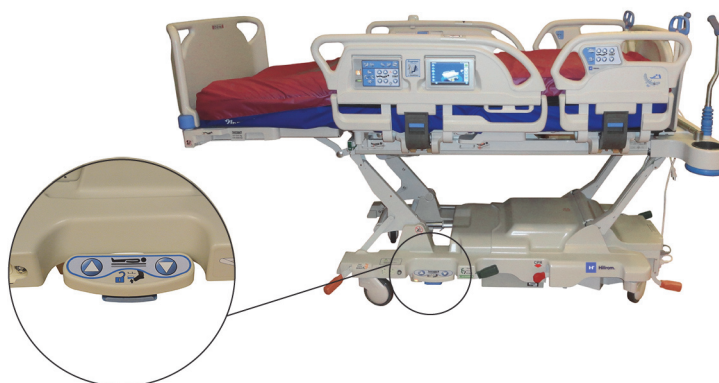

To Activate

1. With your toe, lift up on the blue switch on the bottom of the foot control until you hear a beep (approx. 3 seconds).
 - If you release the blue switch before you hear the beep, three beeps will sound and a message will show on the GCI screen with instructions to enable the foot controls.
2. With your foot, press down on the bed up or bed down control, as applicable.



NIGHT LIGHT

There is a night light on each side of the bed, located on the base frame. The light is on continuously when the bed is plugged into AC power.

EQUIPOTENTIAL GROUND

The Equipotential Ground is located at the head-end of the bed, near the power cord.

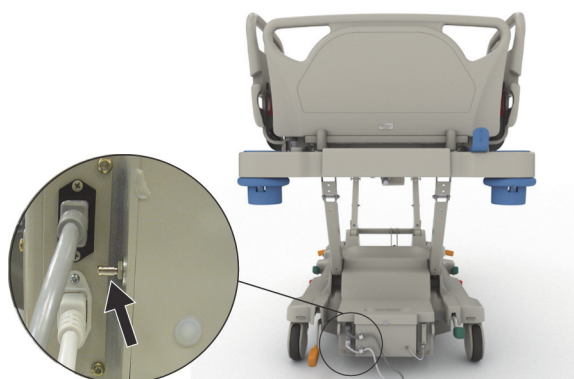

SURFACES



WARNING:

Warning—To help prevent injury and/or equipment damage, obey these **warnings**:

- **Warning**—Some safety features of the bed may not function or may not operate as intended with surfaces not designed specifically for this bed. Check with the surface manufacturer to determine those safety features of the bed that have been tested and verified to work properly with the replacement surface.
- **Warning**—A sound risk assessment and protocol is necessary to determine the appropriate surface for the patient's condition.
- **Warning**—Only **Progressa** Prevention, **Progressa** Pulmonary, and **Progressa** Therapy Surfaces with the Chair Egress feature should be used with the Chair Egress function of the bed.
- **Warning**—Only use **Progressa** Pulmonary and **Progressa** Therapy StayInPlace Surfaces on beds equipped with the StayInPlace Feature or reduced surface performance could occur.
- **Warning**—The **Progressa+** Advance and Accelerate Surfaces weigh approximately 60 lb (27 kg) to 70 lb (32 kg) depending which surface model you have. Always use assistance to move the surface. Failure to do so could cause injury or equipment damage.

NOTES:

- The above warning does not apply to the **Progressa** Prevention Surface. The **Progressa** Prevention Surface has the StayInPlace feature built into the surface. The **Progressa** Prevention Surface can be used on a **Progressa** Bed with or without the StayInPlace feature.
- Hill-Rom recommends the use of **Hillrom** Surfaces that have been designed and tested specifically for the bed. Customers electing to purchase replacement surfaces from other manufacturers should confirm that the replacement surface, when used in conjunction with the bed, meets applicable regulations, regulatory guidance and technical standards and does not create unacceptable risks of injury to patients or caregivers. Specifically, Hill-Rom suggests that surfaces utilize dimensions and construction to minimize gaps where entrapment could occur, provide for sufficient height between the surface and the top of the siderail to prevent accidental roll-over events, provide appropriate firmness at the edges of the surface to facilitate safe transfers into and out of the bed, and do not interfere with the proper operation of siderails.

There are three primary surfaces: **Progressa** Prevention, **Progressa** Therapy, and **Progressa** Pulmonary.

Refer to “Surface Compatibility” on page 115 for a list of surfaces and bed frame function compatibilities.

Refer to “Product Configuration Identification” on page 129 to identify the surface installed on the bed.

For an air surface to operate correctly, there must be a minimum of 70 lb (32 kg) on the surface.

Loose fitting sheets (preferably knitted) must be used for correct operation of the surface.

The **Progressa** Bed surfaces are designed especially to work with the following system features:

- StayInPlace Patient Positioning
- **SlideGuard** Patient Position Mechanism
- **FlexAfoot** Retractable Foot Mechanism
- Chair Egress Patient Exit Position Mechanism

PROGRESSA PREVENTION/ESSENTIAL SURFACE

The **Progressa** Prevention Surface is foam with non-powered air cylinders.

PROGRESSA THERAPY SURFACE



CONTRAINDICATION:

Contraindication—Use of active air therapy surfaces for patients with unstable spinal cord injury could cause serious injury to the patient.

The **Progressa** Therapy Surface has a MicroClimate Management (**MCM**) topper that operates continuously while the patient is on the bed and helps decrease localized heat and moisture buildup that occurs between the patient and the surface.

Modes

Normal

The normal mode of the surface provides continuous full-body pressure redistribution for patients 70 to 500 lb (32 to 227 kg). The surface provides pressure redistribution by automatically adjusting the air system to accommodate changes in weight distribution.

Loose fitting sheets (preferably knitted) must be used to optimize the surface pressure redistribution.

Pressure Redistribution is always active unless one of these occur:

- Max-Inflate/P-Max Inflate is active
- AC power is not available
- An error with the surface



WARNING:

Warning—To help prevent injury and/or equipment damage, obey these **warnings**:

- **Warning**—The therapy surface is not a substitute for good nursing practices. Therapy modes should be used in conjunction with good assessment and protocol. Failure to follow good nursing practices may result in patient harm.
- **Warning**—Sleep surface impermeability and pressure relieving capabilities of the surface could be affected by needle sticks or other bladder punctures. Caregivers should be instructed to AVOID surface cover and bladder damage caused by improper use of x-ray cassette holders

and sharp objects that may puncture or lacerate the surface. The surface should be regularly inspected for damage. Undetected damage to the surface may result in patient harm.

Refer to the GCI home screen or Surfaces status page on the GCI screen to determine the active therapy surface mode.

To Put the Surface in Normal Mode

1. Press the **Surface** menu control on the GCI home screen.
2. Press **Normal**.



WARNING:

Warning—Patients with body weight or height near the recommended limits should be monitored more frequently for desired results. Lower the head section to optimize pressure performance if necessary.

Max-Inflate/P-Max Inflate

The Max-Inflate/ P-Max Inflate mode maximizes the firmness of the primary section of the patient surface. This assists in patient surface-to-surface transfers and/or repositioning.

NOTE:

The **Progressa** Therapy Surface will automatically exit the Max-Inflate/P-Max Inflate mode and return to normal mode after 30 minutes. After 28 minutes, a beep will sound and a message will show on the GCI screen that there are 2 minutes left. The caregiver has the option of keeping the surface in Max-Inflate or let it return to normal mode.

To Activate

1. Press the **Surface** menu control on the GCI screen.



2. Press **Max-Inflate/P-Max Inflate**.

To Deactivate

1. Press the **Surface** menu control on the GCI screen.
2. Press **Normal**.



To Activate—Siderail method

Press the **Max-Inflate /P-Max Inflate** control.



To Deactivate—Siderail method

Press the **Max-Inflate/P-Max Inflate** control.

Seat Deflate

The Seat Deflate feature allows for easier bedpan placement.



WARNING:

Warning—Seat deflate is not recommended for side sitting or side egress. Injury could occur.

To Activate

1. Press the **Surface** menu control on the GCI screen.



2. Press **Seat Deflate**.



The **Progressa** Therapy Surface will automatically exit the Seat Deflate mode and return to normal mode after 30 minutes. After 28 minutes, a beep will sound and the GCI screen will show that there are 2 minutes left.

To Deactivate

1. Press the **Surface** menu control on the GCI screen.
2. Press **Normal**.

Patient Comfort

Allows customizing based on patient request while maintaining pressure redistribution.

The system automatically supplies pressure distribution for the patient's position on the surface.

To Adjust the Firmness

1. Press the **Surface** menu control on the GCI screen.



2. Press **Patient Comfort**.



3. Use the **Patient Comfort** controls to change the pressure in the head, seat, and lower leg sections of the mattress assembly:

- To **Increase** the pressure, press the **Up** arrow.
- To **Decrease** the pressure, press the **Down** arrow.

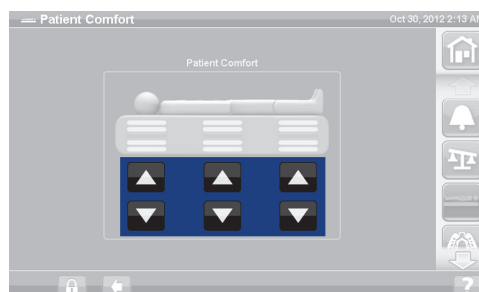

To Deactivate

1. Press the **Surface** menu control on the GCI screen.

2. Press **Normal**.

Sleep Mode

The Sleep Mode is available on some bed models. The Sleep Mode is used to reduce frequency of air system adjustments for patients who are sensitive to air surface movements. Pressure redistribution is active during Sleep mode. The air pressure in the surface is monitored, but the air pump does not run unless the air pressure falls below or raises above a preset level.

After eight hours the Normal mode reactivates

To Turn On the Sleep Mode

1. Press the **Surface** menu control on the GCI screen.



2. Press **Sleep Mode**.



To Turn Off the Sleep Mode

1. Press the **Surface** menu control on the GCI screen.
2. Press **Normal**.

Turn Assist

The Turn Assist mode will inflate the surface assisting the caregiver to turn the patient for linen changes, dressing changes, bed pan placement, back care, and other nursing procedures. Pressing Right Turn Assist will turn the patient to the patient's right side.

NOTE:

For enhanced posterior patient access, Max-Inflate/P-Max Inflate may be used once the patient has been turned to the desired side.

The siderail the patient is turning towards **MUST** be in the up position to activate turn assist. If the siderail is down, a triple beep will sound and a message will appear on the GCI screen indicating the rail must be up to initiate. Once the patient has started to turn, the siderail the patient is turning away from can be lowered for easier patient access. Three beeps will sound as a safety alert, and a message will appear on the GCI screen when the siderail is lowered.

To Activate

1. Press the **Surface** menu control on the GCI screen.
2. Press **Right** or **Left Turn Assist**. The control turns **green** when active.
 - To stop Turn Assist, press the **Normal** control.
 - To hold the turn at less than the full angle, press the **Hold** control while the Turn Assist is inflating.

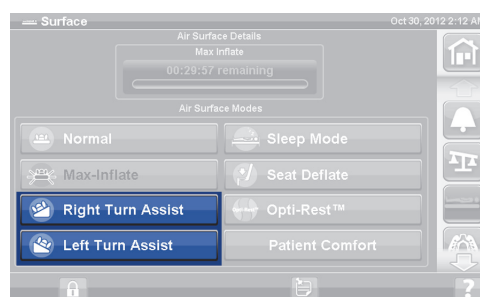

After 28 minutes, a beep will sound and a screen will appear that there are 2 minutes left. The caregiver has the option of keeping the surface in Turn Assist or let it return to Normal Mode.

If the siderail the patient is turning towards is lowered the turn assist will stop.

To Deactivate

- Press **Normal**.

PROGRESSA PULMONARY SURFACE

The **Progressa** Pulmonary Surface features are the same as the **Progressa** Therapy Surface, with the addition of Rotation, Percussion and Vibration, and Opti-Rest features. Refer to “Progressa Therapy Surface” on page 72 for **Progressa** Therapy Surface operation.



CONTRAINDICATION:

Contraindication—Use of active air therapy surfaces for patients with unstable spinal cord injury could cause serious injury to the patient.

Contraindication—Use of continuous lateral rotation therapy is contraindicated for patients with cervical or skeletal traction.



WARNING:

Warning—To help prevent injury and/or equipment damage, obey these **warnings**:

- **Warning**—Use care when you transfer a patient from the bed to another surface.
- **Warning**—Operating Percussion and Vibration and Rotation Therapy together at higher than typical settings may cause elevated surface temperatures and patient harm, for example, the combination of the following control settings:
 - Rotation therapy programmed at 100% with a 1 minute center pause time
 - Rotation therapy operating continuously
 - Percussion and Vibration programmed at a high setting
 - Percussion and Vibration operating for 1 hour periods, greater than the rate of 1 hour for every 5 hours of Rotation therapy operation
- **Warning**—The patient may move laterally on the surface when rotation is active.
- **Warning**—Monitor the condition of the patient’s skin when extended dwell times are used during continuous lateral rotation therapy.

The recommended therapeutic weight range for pressure relief and turning capabilities is 70 to 500 lb (32 to 227 kg).

The pulmonary surface has a MicroClimate Management (**MCM**) topper that operates continuously while the patient is on the bed and helps decrease localized heat and moisture buildup that occurs between the patient and the surface.

The surface uses input from the bed scale system to adjust the cushion pressures based on the patient’s weight.



WARNING:

Warning—Sleep surface impermeability and pressure relieving capabilities of the sleep surface could be affected by needle sticks or other bladder punctures. Caregivers should be instructed to AVOID surface cover and bladder damage caused by improper use of x-ray cassette holders and sharp objects that may puncture or lacerate the surface. Reduced performance could occur.

Rotation

The rotation mode provides gentle, side-to-side, continuous lateral rotation therapy (CLRT) to aid in the prevention and treatment of pulmonary complications related to immobility. Patients can be positioned laterally on the right or left side with varying amounts of turn and pause times to match each individual patient’s condition. Pressure redistribution is provided when the rotation mode is active.

Rotation Reminders:

- Rotation therapy will be suspended when:
 - Any siderail is lowered. To restart rotation - raise siderail to the up and locked position.
 - Head of Bed (HOB) is raised higher than 40 degrees. To restart rotation - lower HOB.
 - Foot of Bed (FOB) is lowered more than 30 degrees. To restart rotation - raise FOB.
 - Chair position is attempted. To restart rotation - exit chair position.
 - Percussion/Vibration, Max-inflate/P-Max Inflate, or Turn Assist is active.
- A message will show on the GCI screen when therapy has been suspended for any of the above conditions.
- If CPR is activated, rotation therapy automatically stops and Max-inflate/P-Max Inflate is activated. If Max-inflate/P-Max Inflate is active for 60 minutes the surface will return to normal mode and not the previous therapy mode.
- Check the GCI screen if you are uncertain why the bed is beeping - the reason will be displayed on the GCI screen.

**WARNING:**

Warning—To help prevent injury and/or equipment damage, obey these **warnings**:

- **Warning**—Observe lines closely during rotations and/or patient positioning. Always use good line management techniques to prevent lines and tubing from becoming dislodged during rotation and/or patient positioning.
- **Warning**—During rotation, monitor patient rotation position and make sure that the patient stays centered on the surface with shoulders correctly aligned and that there is sufficient slack in lines for patient movement and surface rotation.

Setup

1. Put the patient on the bed.
2. Align the shoulders with the shoulder position label located on the inside of the head-end siderail.

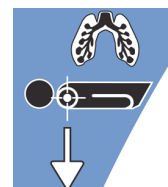
**Start Rotation****NOTES:**

- If Rotation Therapy is desired with Bed Exit on, Bed Exit must be turned on before Rotation Therapy is started. Only Out of Bed Mode will work during Rotation Therapy.
 - Bed Exit Position Mode (most sensitive) or Exiting Mode (middle mode) is active, Bed Exit will switch to Out of Bed Mode (least sensitive) during Rotation Therapy. Once the therapy is complete the bed will re-arm to the initial Bed Exit Alert Mode.
1. Press the **Pulmonary Therapy** menu control on the GCI screen.



2. Press **Rotation**.

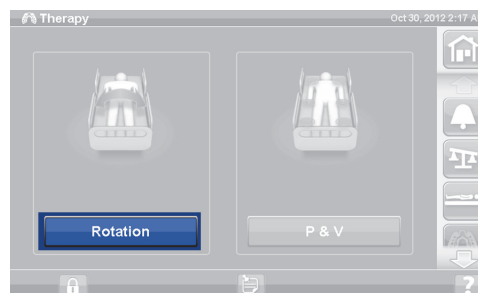

3. Select **Full, Moderate, Minimum** or **Custom**.
4. Training Mode/Patient Acclimation: Yes/No (Starts rotation at 50% of maximum programmed turn and increases 10% each hour for patient acclimation).

NOTE:

Patient Acclimation shows on some bed models. Patient Acclimation has the same function as the Training Mode. Press the drop down menu to select the applicable setting.

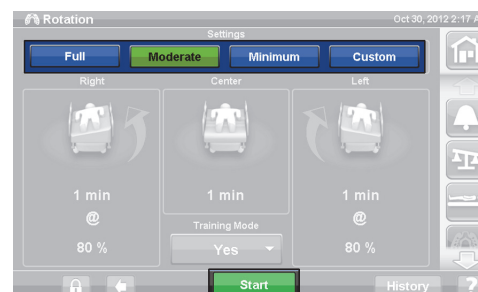

5. Press **Start** to begin Rotation.

NOTE:

Some bed models have the Preview function. The Preview function moves through the rotation therapy settings without any pauses to check lines and patient condition. The therapy will not start automatically. See the Accelerate Surface Rotation screen below.



Pulmonary Surface (P7520) Rotation Screen



Accelerate Surface (P7540) Rotation Screen

Stop Rotation

1. Press the **Pulmonary Therapy** menu control on the GCI screen.
2. Press **Rotation**.
3. Press **Stop Therapies** or On the GCI home screen, press **Stop Therapies**.

Set Custom Settings

1. Press **Custom** or the desired setting, see below.
2. Press the value for the applicable setting.
3. Move the slider bar to the applicable setting.
4. Press **Start** when all settings are correct.

The following settings can be customized:

- Right turn %: Customize the amount of turn to the right
- Pause Time (Right, Center, Left): Amount of time in side-lying or centered position
- Left turn %: Customize the amount of turn to the left side



Pulmonary Surface (P7520) Rotation Screen

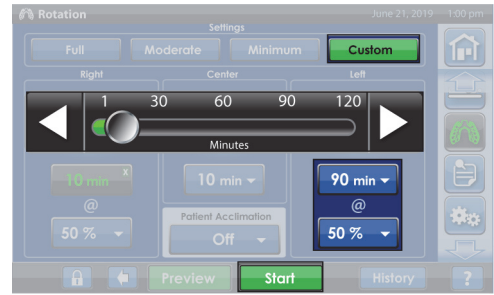

Accelerate Surface (P7540) Rotation Screen

Percussion and Vibration



CONTRAINDICATION:

Contraindication—Use of active air therapy surfaces for patients with unstable spinal cord injury could cause serious injury to the patient.

The percussion and vibration therapies can be done separately or together as a sequential treatment.

Treatments can be done with the patient in the supine or the right or left side lying positions to facilitate postural drainage or in conjunction with rotation.

Use the same treatment parameters as for manual percussion/vibration regarding frequency and duration, as directed by physician's orders.

Setup

1. Put the patient on the bed.
2. Align the shoulders with the shoulder position label located on the inside of the head-end siderail.



Start Percussion and Vibration

1. Press the **Pulmonary Therapy** menu control on the GCI screen.
2. Press **P & V**.
3. Select **High, Medium, Low, or Custom**.
4. Press **Modify** to change the position.
5. Select **Left, Center, Right, or Rotation** position.
6. Press **back arrow**.
7. Press **Start** to begin P&V.



NOTE:

If Percussion and Vibration is desired with Bed Exit on, Bed Exit must be turned on before Percussion and Vibration is started. Only Out of Bed Mode will work during Rotation Therapy.

Stop Percussion and Vibration

1. Press the **Pulmonary Therapy** menu control on the GCI screen.
2. Select **Percussion** and **Vibration**.
3. Press **Stop Therapies** or on the GCI home screen, press **Stop Therapies**.

Alternatively, Percussion and Vibration Therapy will stop after the allotted time. It can also be stopped earlier using the steps above.

If rotation therapy is on and Percussion and Vibration is started (in left, right, or center), Rotation will be turned off automatically. Turn Rotation back on if desired.

Set Custom Settings

1. Press **Custom**.
2. Press the applicable setting.
3. Change the setting as applicable.
4. Press **Start** when all settings are correct.

**The following settings can be customized:**

- Position: Right/Left/Center or Rotation
- Turn %: For right and left position only
- Percussion/Vibration: Right/Left/Center or Rotation
- Percussion frequency: 1 to 5 Beats per Sec
- Intensity: Low-Med-High
- Duration: 5 to 30 minutes, adjusted in increments of 5 minutes.
- Vibration frequency: 5 - 25 Beats per Sec (BPS)
- To operate Percussion and Vibration separately, select *Intensity Off* for the therapy that is not desired.

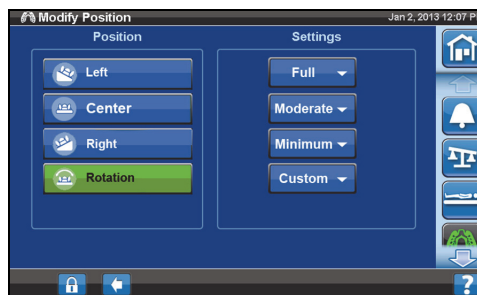

Opti-Rest

The Opti-Rest mode offers wave-like motions in the surface while maintaining pressure relief. It adjusts the pressure in the chest, seat, and thigh zones producing a massaging wave-like action.

Start Opti-Rest

1. Press the **Surface** menu control on the GCI screen.



2. Press **Opti-Rest**.
3. Opti-Rest is active when the button turns **green**.

Stop Opti-Rest

1. Press the **Surface** menu control on the GCI screen.
2. Press **Normal**.

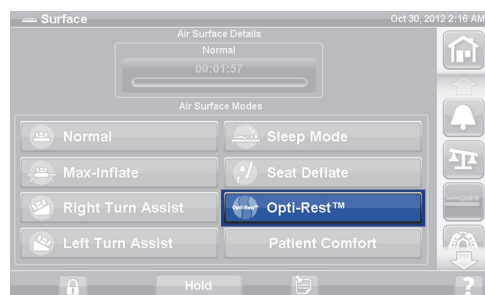

Patient History

To view the Patient History:

1. Press the **Preferences** menu control on the GCI home screen.
2. Press **History**.
3. Select the desired history to be viewed.

A History control is present in each area of the GCI screen that has history associated with it.

Rotation: Displays the maximum number of cycles/hour the patient has rotated and Hrs: Mins in rotation, in 24 hours.

Percussion and Vibration: Displays the number of treatments provided per 24-hour period.

OPTI-REST: Time spent in OPTI-REST mode since 12 am.

Head Angle: Time spent with the head of bed more than 30° or 45° since 12 am.

Weight: Displays the weight increase or decrease in 24-hour periods.

Chair: Time spent in Chair position since 12 am.

Bed Exit: Displays the time spent with the Bed Exit alert on.

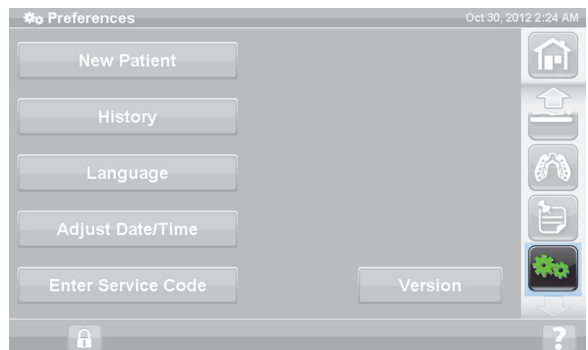

PATIENT CONTROLS

This section will describe the controls and features of the bed intended to be used by the patient. Not all features or controls listed are present on all beds.

When a caregiver locks out a control, the patient control for that feature is also locked out. Refer to "Lockout Controls" on page 14.

LOCATION

The Patient Positioning controls are located on the inboard side of the intermediate siderails.



NURSE CALL

On beds equipped with the Nurse Call option, NURSE call controls for the patient are located on the inboard side of the intermediate siderails.

To Activate

- Press the **Nurse Call** control.
- When the nurse station acknowledges the nurse call, the inboard indicator continuously illuminates amber and the outboard indicator does not illuminate.
- When the nurse station communication line is open, both the inboard and the outboard indicators continuously illuminate green.



After transport, connect the bed's Nurse Call cord to the facility communication system. Use only Hill-Rom communications cables for proper operation of the Nurse Call system.

HEAD UP/DOWN CONTROL

The patient can raise or lower the head section by using the Head Up/Down controls. Operation of this feature is the same as that for the caregiver control previously described in this manual except head elevation is restricted to a maximum of 55°. The Auto Contour feature will work from the head/up down patient controls as well.



KNEE UP/DOWN CONTROL

The patient can raise or lower the knee section using the Knee Up/Down controls. Operation of this feature is the same as that for the caregiver control previously described in this manual.

NOTE:

When in the Chair Egress position, the knee controls are locked out.



ROOM LIGHT

The Room Light control operates the room light.

To Activate

1. Press the **Room Light** control.

To turn off the *Room Light*, press the **Room Light** control again.



READING LIGHT

The Read Light control operates the reading light, if present.

To Activate

1. Press the **Reading Light** control.

To turn off the *Reading Light*, press the **Reading Light** control again.



TELEVISION

The Television control turns the television on and off.

To Activate

1. Press the **Television** control.

To turn off the television, press the Television control until the television turns off.



RADIO

The Music/Select control turns the music on and off.

To Activate

1. Press the **Radio** control.

To turn off the *Radio*, press the **Radio** control again.



TELEVISION CHANNEL UP/DOWN CONTROL

The Television Channel Up/Down control changes the channel for the television or radio.

To Activate

1. Press the + or - control.
2. To reach the desired channel, continue to press the control.



VOLUME CONTROL

The Speaker Volume control changes the volume of the radio and television.

To Activate

Press the + or - control to adjust the volume level.



ACCESSORIES

Accessories may be added or removed at the point of patient care by a caregiver without the use of tools. Accessories are interchangeable within a product configuration.

Accessories

Product Number	Description	Usable Equipment Sockets	
		Head-End	Foot-End
P158A	Infusion Support System	X ^a	
P7515A	ISS pole adapter kit	X	
P7510A	Removable IV Pole	X	
P2217A	Removable Telescopic IV Pole	X ^a	X
P7511A	Permanent IV Pole	X	
P7514A	IV Pole adapter kit (for P2217 IV pole)	X	
P7512B	Line manager kit	X	
P7507A01/02/03/04	Caregiver Pendant	Refer to "Caregiver Pendant Controls" on page 24.	
P7524A	Transport Shelf		X
P008712 ^b	Kinetec oxygen tank holder	X	
P752801/02/03	Head extension	Refer to "Head Extension (P752801/P752802/P752803)" on page 90.	
P7529	Proning kit	Refer to "Proning Kit (P7529)" on page 91.	
P7546A01	Experience Pod Device (Overhead Arm)	Refer to "Experience Pod Device (Overhead Arm) (P7546A01)" on page 93.	

a. Requires adapter.

b. Available in select countries where type B5 (140 mm) cylinders are commonly used. Manufactured by **Kinetec**.

INFUSION SUPPORT SYSTEM (P158A)

**WARNING:**

Warning—To help prevent personal injury or equipment damage, obey these **warnings**:

- **Warning**—Do not exceed 20 lb (9 kg) load capacity (safe working load) of the infusion support system (ISS) pole.
- **Warning**—Correctly attach the ISS pole; otherwise, it may fall.
- **Warning**—Uneven loading of the ISS pole could cause the contents to fall.
- **Warning**—When you lower the upper section of an ISS pole, always grasp and hold the upper section of the pole before pulling the release knob.
- **Warning**—Do not mount infusion pumps on the lower section of an IV pole. Interference with head section articulation could result.

The Infusion Support System (ISS) consists of a movable and adjustable IV pole. The pole supports IV pumps or bags in a vertical orientation and raises or lowers the pumps or bags with respect to the bed frame.

The head end of the bed has attaching points for two mobile Infusion Support Systems. Each Infusion Support System can support one infusion pump plus two liters of intravenous solution.

The ISS pole installs in to one of the IV pole sockets with the **P7515A adapter kit**.

The P158A ISS IV pole is a removable, two section telescopic pole that installs at the head end of the bed into an adapter that snaps into the receiver holes. The IV pole can hold 20 lb (9 kg).

REMOVABLE IV POLE (P7510A)

**WARNING:**

Warning—To help prevent injury and/or equipment damage, obey these **warnings**:

- **Warning**—Keep hands away from the connection between the sliding parts when raising and lowering the movable portion of the IV pole.
- **Warning**—Exceeding the safe working load can cause injury or equipment damage.

The IV pole is a removable, three section, telescopic pole that installs at the head end of the bed, in the hole provided. A permanently attached adapter is required. The IV pole can hold 40 lb (18 kg).

To install the standard IV pole, insert and rotate a quarter-turn clockwise. Removal is opposite of installation.

**CAUTION:**

Caution—When lowering the upper section of an IV pole, always grasp and hold the upper section of the pole before pulling the release knob.

NOTE:

Added height recommended for gravity drain applications.

REMOVABLE TELESCOPIC IV POLE (P2217A)

**WARNING:**

Warning—To help prevent injury and/or equipment damage, obey these **warnings**:

- **Warning**—Keep hands away from the connection between the sliding parts when raising and lowering the movable portion of the IV pole.
- **Warning**—Exceeding the safe working load can cause injury or equipment damage.
- **Warning**—Do not exceed the 11 kg (25 lb) load capacity of the IV pole.
- **Warning**—Uneven loading of the IV pole could cause the contents to fall.

The P2217A IV pole is a removable, two section telescopic pole that installs at any of the four corners of the bed, with adapters for the holes at the head end of the bed. The IV pole can hold 25 lb (11 kg).

To install the P2217A IV pole, insert and rotate a quarter-turn clockwise. Removal is opposite of installation.

PERMANENT IV POLE (P7511A)

**WARNING:**

Warning—To help prevent injury and/or equipment damage, obey these **warnings**:

- **Warning**—Keep hands away from the connection between the sliding parts when raising and lowering the movable portion of the IV pole.
- **Warning**—Exceeding the safe working load can cause injury or equipment damage.
- **Warning**—Do not exceed the 40 lb (18 kg) load capacity of the IV pole.

The P7511A IV pole is a permanently installed telescopic pole that installs at the head end of the bed, in the left or right IV pole sockets. The P7511A IV pole is normally ordered with a new bed, but can be added to a bed that is in service. The P7511A IV pole can hold 40 lb (18 kg).

If the P7511A IV pole is not installed, there is an adapter bushing installed to allow use of a removable IV pole.

To Stow

Pull up on the IV pole, and fold it down toward the center of the bed.

To Use

Pull up on the IV pole from the stowed position so that it is in the vertical position. The IV pole will then move down to lock in the vertical position.

VERTICAL OXYGEN TANK HOLDER

The oxygen tank holders are located in the head end corners of the upper frame. The blue sleeve holds a steel tank and the gray sleeve holds an aluminum tank. Each oxygen tank holder accommodates one **D**-size or **E**-size oxygen tank with a regulator.



WARNING:

Warning—Each vertical oxygen tank holder safe working load is 30 lb (13.6 kg). Exceeding the safe working load can cause injury or equipment damage.

To Install

Install the oxygen tank in the holder. Depending on the date of manufacture, the holder will have either a rigid plastic bottom or a spring-loaded metal support cage.

If the holder has a spring-loaded metal support cage, make sure that the support cage completely lowers when you install the tank.

To Remove

Lift the tank out of the holder.

NOTE:

A blue insert sleeve is required for steel oxygen tanks. A gray insert sleeve is required for aluminum oxygen tanks.

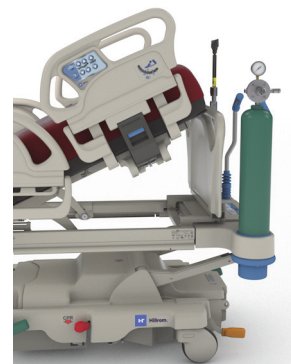

KINETEC OXYGEN TANK HOLDER

The **Kinetec** oxygen tank holder is a removable tank holder that can be installed at the head end of the bed, in the left or right IV pole sockets. The oxygen tank holder accommodates cylinder type B5 with a regulator.



WARNING:

Warning—Make sure the headboard is installed when the oxygen tank holder is in place. Patient injury may occur.

To Install

Install the oxygen tank holder in the left or right IV pole socket. Make sure the openings in the holder align with the space in the bed frame.

To Remove

Lift the holder out of the IV pole socket.

TRANSPORT SHELF



WARNING:

Warning—To help prevent injury and/or equipment damage, obey these **warnings**:

- **Warning**—Do not exceed the 45 lb (20.4 kg) safe working load of the transport shelf. To do so could cause the shelf to fail.
- **Warning**—The foot section must be flat for you to use the transport shelf. Otherwise, the equipment could fall.
- **Warning**—Do not stand or sit on the transport shelf.
- **Warning**—Failure to use the straps to hold equipment on the shelf could permit the equipment to fall.
- **Warning**—After use, make sure the shelf is locked into the stowed position. Failure to do so could cause the shelf to accidentally contact the floor when you use the bed articulation controls.
- **Warning**—When the footboard is removed from the bed, do not lay the footboard flat on the floor. Store the footboard in a position or location so that it does not come in contact with biohazards.

NOTE:

If the footboard does **not** have a transport shelf installed, the footboard can set upright on the floor. If a transport shelf is installed, the footboard can be put against a wall in a position so that it will not fall.

The transport shelf can be used to hold small equipment during patient transport and as a writing surface.

To Use

1. Make sure the foot section is flat.
2. Lift the shelf up and over the footboard toward the sleep surface until the shelf stops in the horizontal position.



To Stow

1. Remove all equipment from the shelf, and connect the hook and loop straps.
2. Lift the shelf up and over the footboard away from the sleep surface until the shelf is flat against the footboard and is locked in position.



HEAD EXTENSION (P752801/P752802/P752803)



WARNING:

Warning—To help prevent injury and/or equipment damage, obey these warnings:

- **Warning**—Make sure the bed brakes are set and that there is no patient on the bed before you install or remove the head extension.
- **Warning**—Do not exceed the 254 lb (115 kg) safe working load of the head extension. To do so could cause the head extension to fail.
- **Warning**—Use the head extension under direct caregiver supervision only. Remove the head extension when the patient is to be left alone.
- **Warning**—Do not use the bed scale when the head extension is installed. The head extension will cause inaccurate scale readings.
- **Warning**—Do not transport a patient with the head extension installed.
- **Warning**—Only use authorized replacement parts from Hill-Rom.

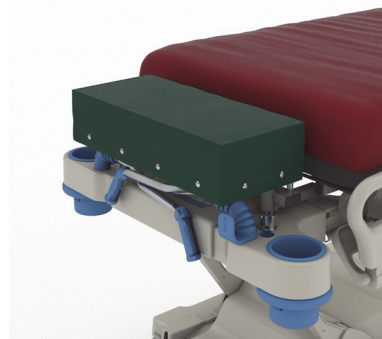

CAUTION:

Caution—Do not kneel or sit on the head extension. To do so could cause equipment damage.

NOTES:

- The head extension is used to position the patient's head closer to the caregiver and is intended to be used only during routine non-urgent procedures.
- The head extension can only be installed when the headboard is removed, the head section is flat, and the transport handles are in the stowed position.
- The headboard must be installed on the bed when not using the head extension.

To Install

1. Make sure the bed brakes are set and a patient is not on the bed.
2. Remove the headboard.
3. Install the two head extension legs into the holes for traction equipment.

NOTE:

The shorter head extension legs will rest on the head weldment on the bed.

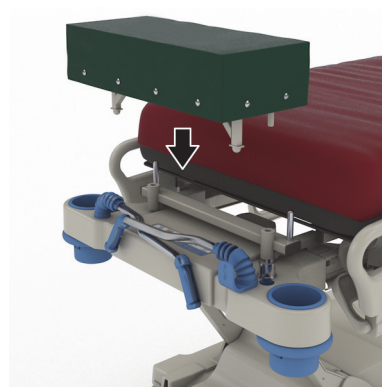

To Remove

1. Make sure the patient is not on the bed.
2. Lift the head extension up and out from the bed.
3. Install the headboard.

PRONING KIT (P7529)



WARNING:

Warning—To help prevent injury and/or equipment damage, obey these warnings:

- **Warning**—Before using the proning accessory with a patient, read and understand *Instructions for Use* (773439).
- **Warning**—Make sure the bed brakes are set before you install or remove the proning accessory.
- **Warning**—Do not exceed the 44 lb (20 kg) safe working load of the head support proning accessory.
- **Warning**—Do not transport a patient with the proning accessory installed.
- **Warning**—Only use authorized replacement parts from Hill-Rom.
- **Warning**—Do not lean, kneel, or sit on the proning accessory.
- **Warning**—Lock out the head and knee articulation controls when the proning accessory is in use.
- **Warning**—Make sure patient's head is correctly aligned on the foam face cushion/ head support of the proning accessory. Monitor the position and adjust as needed once the patient is in the prone position.
- **Warning**—Do not initiate any therapy modes (turn assist, rotation therapy, or any therapy that could cause patient movement) on the bed when the proning accessory is in use.
- **Warning**—Make sure the integrated air surface, if applicable, is in normal mode when the proning accessory is in use.
- **Warning**—Observe lines and tubes closely during patient positioning.
- **Warning**—Make sure the headboard is installed after the proning accessory is removed.
- **Warning**—Instruct conscious patients not to adjust the proning accessory without the assistance of a caregiver.
- **Warning**—Make sure to remove the ICU prone head positioner's detachable ball joint lock handle from the ball joint after it is locked and the patient is in the prone position.
- **Warning**—Do not store equipment below the head adapter bracket when the proning accessory is in use.
- **Warning**—Adjust the patient, if necessary, after any surface transition or bed articulation to make sure the head is correctly aligned on the foam face cushion/head support of the proning accessory.
- **Warning**—Make sure to monitor and adjust the patient at regular intervals.
- **Warning**—Make sure to adjust the patient when the integrated air surface transitions from max-inflate to normal mode.
- **Warning**—Stay clear of pinch points when you adjust the **Allen** ICU prone head positioner that the mirror.



NOTE:

For technical support of the proning accessory, contact Hill-Rom Allen Medical (800) 433-5774.

To Install

1. Put the bed in the flat position.
2. Remove the headboard.
3. Lower the transport handles and IV pole.
4. If applicable, remove any equipment from the fracture frame sockets.
5. Lockout the head and knee articulation controls.



6. If applicable, remove the plastic inserts from the traction equipment sockets on the head-end of the bed.

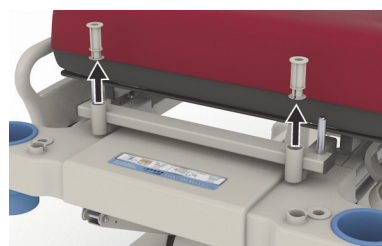

7. On the left side of the head adapter bracket, push the snap button to install the head adapter bracket in the traction equipment sockets. Make sure the bracket is fully inserted into the socket.

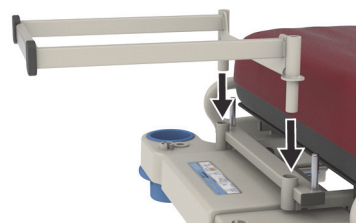

NOTE:

If applicable, the push handles and IV pole will be in the stowed position and will be under the bracket.

8. Install the **Allen ICU prone head positioner**. See **Allen ICU Prone Head Positioner Instructions for Use (773439)** to install and to make adjustments to the prone head positioner.

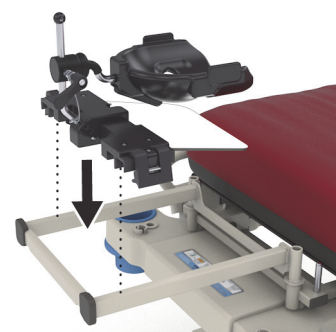

To Use

To use the proning accessory, see **Allen ICU Prone Head Positioner Instructions for Use (773439)**.

To Remove

1. Make sure the patient is not on the proning accessory before you remove it.
2. Remove the prone head positioner (see **Allen ICU Prone Head Positioner Instructions for Use (773439)**).
3. Remove the head adapter bracket support from the traction equipment sockets.
4. If applicable, disable any lockout controls.

5. Adjust the IV Pole and transport handles, as applicable.
6. Install the headboard.

EXPERIENCE POD DEVICE (OVERHEAD ARM) (P7546A01)

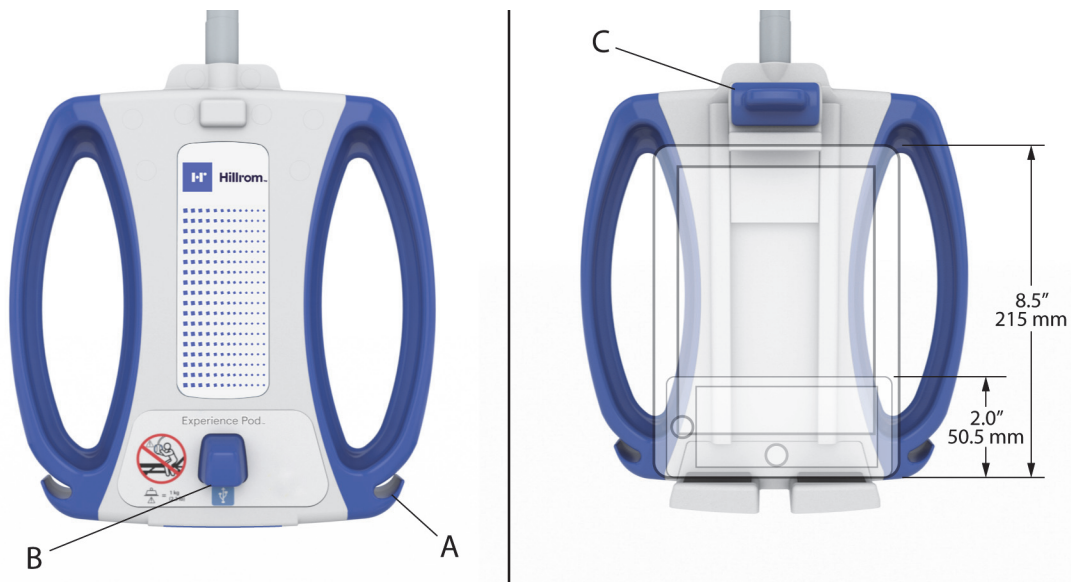

Item	Description	Item	Description
A	Personal Electronic Device (PED) cord storage	C	PED holder
B	USB charging port		



WARNING:

Warning—To help prevent injury and/or equipment damage, obey these **warnings**:

- **Warning**—Do not exceed the 1 kg (2.2 lb) load capacity of the Overhead Arm.
- **Warning**—Do not remove or install the Overhead Arm assembly while it is in a position over a patient.
- **Warning**—Stay clear of pinch points and moving parts when putting the Overhead Arm in the transport position.
- **Warning**—Put the Overhead Arm in the transport position and make sure the power cord is unplugged and stored correctly prior to transport (Step 4 on page 96).
- **Warning**—Instruct patients to never use the Overhead Arm to assist them when they get in or out, or reposition themselves in the bed.
- **Warning**—When the Overhead Arm is installed and you adjust the bed and/or head section height, be careful that the arm does not contact the patient.
- **Warning**—Before you remove the Overhead Arm, make sure the power cord is unplugged and stored correctly.



CAUTION:

Caution—To help prevent equipment damage, obey these **cautions**:

- **Caution**—Use caution when you move the bed through doorways. Equipment damage could occur.
- **Caution**—Use caution when you adjust the bed height. Make sure that the bed will not hit the overhead lights and doorways.
- **Caution**—Use caution when you use trend and reverse trend. Make sure the bed will not hit the headwall system or other equipment.

NOTE:

Make sure to put the overhead arm in the transport position to transport the bed, see Step 4 on page 96.

With the **Experience Pod** Device, you can—

- Charge the PED
- Put your PED in the PED holder (see above for the PED dimensions supported)
- Store the PED charging cord
- Adjust the **Experience Pod** Device for optimal use



NOTES:

- The USB port is not designed for devices that require less than 170 mA of power such as USB reading lights, but supports up to 2.4 A of current.
- If two permanent IV poles are installed on the bed, one IV pole will need to be removed to accommodate the **Experience Pod** Device.

To Install

1. Make sure the bed's brake is set, and a patient is not in the bed.
2. Raise the bed to access underneath the head section.

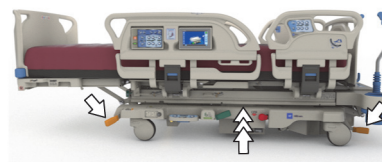

NOTE:

Make sure the **Experience Pod** Device is in the transport position before installing, see Step 4 on page 96.

3. Remove the pin from the **Experience Pod** Device.

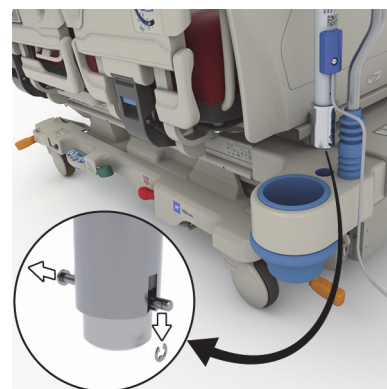

4. Install the **Experience Pod** Device into the accessory socket at the head end of the bed. Make sure the arm assembly is fully inserted into the socket.

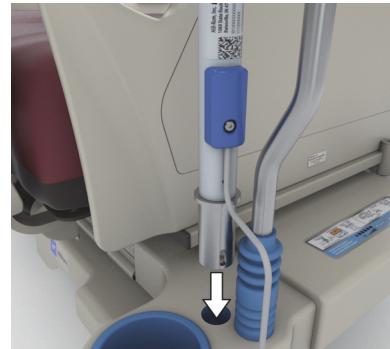
**WARNING:**

Warning—Make sure that the arm is correctly attached in step 4. Otherwise, it may fall. Injury or equipment damage could occur.

5. From underneath the head end of the bed frame, insert the pin to hold the **Experience Pod** Device in position.
6. Install the retainer on to the pin.
7. Make sure the pin is through the retainer.

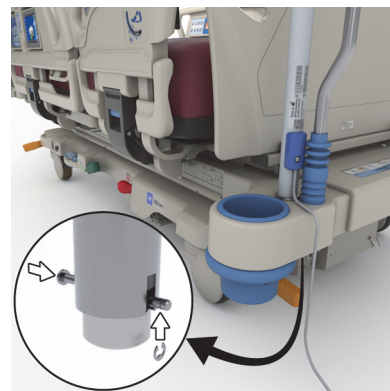

8. Make sure the power cord is connect to the **Experience Pod** Device.

NOTE:

Do not power the **Experience Pod** Device by the auxiliary outlet.

9. Plug the **Experience Pod** Device power cord into AC power.
10. If applicable, plug in the bed power cord.
11. Lower the bed to its lowest position.

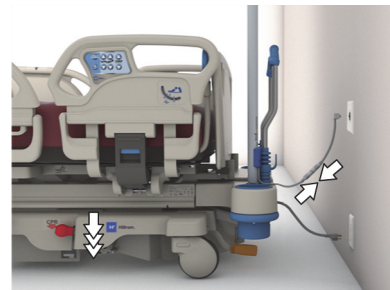
**To Remove**

1. Make sure the bed's brake is set, and a patient is not in the bed.
2. Raise the bed to access underneath the head section.
3. Unplug the **Experience Pod** Device power cord from AC power.

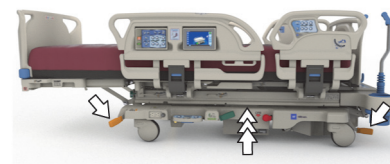

- Put the **Experience Pod** Device in the transport position as shown.



- From underneath the head end of the bed frame, remove the retainer from the pin.
- Remove the pin, and then remove the **Experience Pod** Device from the bed.

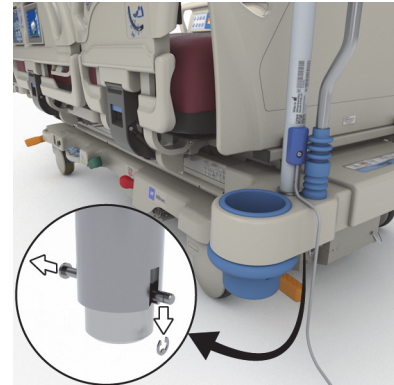

- To store the **Experience Pod** Device, turn the device over and safely stand it up against a wall or put the device in a storage location.

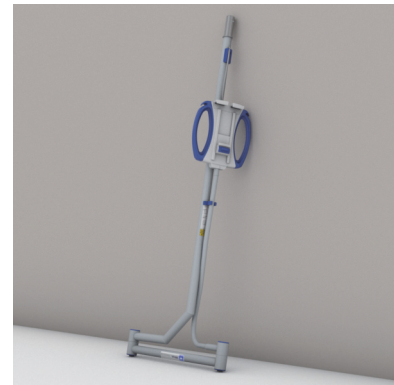

SAFETY INFORMATION

BED POSITIONS

**WARNING:**

Warning—Medical bed should be left in its lowest position when the patient is unattended in order to reduce risk of injury due to falls.

BRAKES

**WARNING:**

Warning—Always set the brakes when the bed is occupied, except during patient transport. To help make sure the bed will not move, push and pull on the bed to check it after the brakes are engaged.

Brakes should always be set when the bed is occupied and especially when moving a patient from one surface to another. Patients often use the bed for support when getting out of bed and could be injured if the bed unexpectedly moves. After setting the brakes, push and pull the bed to make sure of stability. Failure to do so could cause injury or equipment damage.

MAGNETIC RESONANCE IMAGING

**WARNING:**

Warning—The device is not compatible for use in Magnetic Resonance Imaging (MRI). Transfer the patient to a compatible surface to do an MRI, and remove the bed from the MRI room.

Transfer the patient to a compatible surface for an MRI, and remove the bed from the MRI room.

FLUIDS

**WARNING:**

Warning—Fluid spills onto the bed electronics can cause a hazard. If such a spill occurs, unplug the bed, and remove it from service. Failure to do so could cause injury or equipment damage.

When fluid spills occur, outside of those seen in normal use, immediately:

- Unplug the bed from its power source.
- Remove the patient from the bed.
- Clean the fluid spill from the bed.
- Have maintenance inspect the bed completely.

Do not put the bed back into service until it is completely dry, tested, and determined to be safe to operate.

SIDERAILS

Siderails may serve several beneficial uses including providing an edge reminder, bed exit assist, and access to caregiver interface and patient controls. The use of siderails also may provide a sense of security. Siderails should always be in the upright and latched position when the bed is in the chair position. The use of siderails in the bed position should be determined according to patient need after assessing any risk factors according to the facility protocols for safe positioning.

When raising the siderails, a click indicates that the siderails are completely raised and locked in place. Once the click is heard, gently pull on the siderail to make sure the siderail is latched in position.



WARNING:

Warning—To help prevent injury and/or equipment damage, obey these **warnings**:

- **Warning**—Stay clear of the siderail when lowering.
- **Warning**—Evaluate patients for entrapment risk according to facility protocol, and monitor patients appropriately. Make sure that all siderails are fully latched when in the raised position. Failure to do either of these could cause serious injury or death.
- **Warning**—When a patient's condition (such as disorientation due to medication or clinical condition) could lead to patient entrapment, the sleep surface should be left in the flat position while unattended (except when required otherwise by medical staff for special or particular circumstances).

NOTE:

Siderails are intended to be a reminder, not a patient restraining device. Hill-Rom recommends that the appropriate medical personnel determine appropriate siderail usage.

FOOTBOARD



WARNING:

Warning—When the footboard is removed from the bed, do not lay the footboard flat on the floor. Store the footboard in a position or location so that it does not come in contact with biohazards. Failure to do so could cause injury.

NOTE:

If the footboard does **not** have a transport shelf installed, the footboard can set upright on the floor. If a transport shelf is installed, the footboard can be put against a wall in a position so that it will not fall.

RESTRAINTS

When appropriate, Hill-Rom recommends that medical personnel determine the proper methods necessary to help keep patients from pulling out lines or harming themselves or others while in bed.

1. Develop guidelines for all patients that indicate:
 - Which patients may need to be restrained and the appropriate restraint to utilize.
 - The proper method to monitor a patient, whether restrained or not, including time interval, visual check of restraint, etc.
2. Develop training programs for all caregivers concerning the proper use and application of restraints.
3. Maintain the bed at its lowest position whenever a caregiver is not in the room.
4. Clarify the need for restraint devices to families or guardians.

ELECTRICITY

**WARNING:**

Warning—To help prevent injury and/or equipment damage, obey these **warnings**:

- **Warning**—Establish policies and procedures to train and educate your staff on the risks associated with electrical equipment.
- **Warning**—To avoid the risk of electric shock, this equipment must only be connected to supply mains with a protective earth.
- **Warning**—Make sure the position of the bed is such that you can quickly, without obstruction, unplug the power cord(s) from the main power supply if necessary.
- **Warning**—Fluid spills onto the bed electronics can cause a hazard. If such a spill occurs, unplug the bed, and remove it from service. Thoroughly clean the bed and allow it to dry; then have the bed checked by service personnel.
- **Warning**—Improper use or handling of the power cord may cause damage to the power cord. If damage has occurred to the power cord, immediately remove the bed from service, and contact the appropriate maintenance personnel.
- **Warning**—The included power cord set and Li-ion battery may not be used with any other equipment other than the **Progressa** Bed model they are packaged with.
- **Warning**—If the integrity of the external protective earth conductor is in doubt, operate the bed from its internal electrical power source.

**CAUTION:**

Caution—To help prevent equipment damage, obey these **cautions**:

- Before transporting the bed, make sure that the power cord is properly stored on the hook at the head-end of the bed. Failure to do so could cause equipment damage.
- This device meets all requirements for electromagnetic compatibility per IEC 60601-1-2. It is unlikely that the user will encounter problems with this device because of inadequate electromagnetic immunity. However, electromagnetic immunity is always relative, and standards are based on anticipated environments of usage. If the user notes unusual device behavior, particularly if such behavior is intermittent and associated with nearby usage of radio or TV transmitters, cell phones, or electro-surgical equipment, this could be an indication of electromagnetic-interference. If such behavior occurs, the user should try moving the interfering equipment further from this device.

Policies and procedures must be established to train and educate your staff on the risks associated with electric equipment. It is never prudent or necessary for personnel to place any part of their body under or between moving parts of the bed. Whenever a bed is being cleaned or serviced, it should be unplugged from its power source, and the lockouts should be activated to keep the bed from accidentally operating due to the battery backup. Refer to the **Progressa and Progressa+ Bed Service Manual** (171748).

PARTS AND ACCESSORIES

**WARNING:**

Warning—Use of non-authorized parts or accessories on Hill-Rom products may introduce the risk of harm to patients and caregivers.

OPERATING BED/SURFACE PRECAUTIONS



WARNING:

Warning—To help prevent injury and/or equipment damage, obey these **warnings**:

- **Warning**—Do not operate the bed in the presence of flammable gas or vapors.
- **Warning**—Use oxygen administering equipment of the nasal, mask, or ventilator type only. Do not use the bed with oxygen tents or in oxygen rich environments.
- **Warning**—Make sure hands, arms, legs, and feet are not under the bed or between sleep deck sections as they move.
- **Warning**—Make sure you position tubes, lines, and linens away from moving parts.



CAUTION:

Caution—The bed shall only be used with certain hoists, because of the limited space underneath the medical bed.

SLEEP SURFACE/MATTRESS



WARNING:

Warning—Some safety features of the **Progressa** Bed may not function or may not operate as intended with surfaces manufactured by other companies. Check with the surface manufacturer to determine those safety features of the bed that have been tested and verified to work properly with the replacement surface. Failure to do so could cause serious injury or damage to equipment.

NOTE:

Hill-Rom recommends the use of Hill-Rom surfaces that have been designed and tested specifically for the **Progressa** Bed. Customers electing to purchase replacement surfaces from other manufacturers should confirm that the replacement surface, when used in conjunction with the **Progressa** Bed, meets applicable regulations, regulatory guidance and technical standards and does not create unacceptable risks of injury to patients or caregivers. Specifically, Hill-Rom suggests that surfaces utilize dimensions and construction to minimize gaps where entrapment could occur, provide for sufficient height between the surface and the top of the siderail to prevent accidental roll-over events, provide appropriate firmness at the edges of the surface to facilitate safe transfers into and out of the bed, and do not interfere with the proper operation of siderails.



WARNING:

Warning—To help prevent injury and/or equipment damage, obey these **warnings**:

- **Warning**—Sleep surface impermeability and pressure relieving capabilities of the sleep surface could be affected by needle sticks or other bladder punctures. Caregivers should be instructed to AVOID surface cover and bladder damage caused by improper use of x-ray cassette holders and sharp objects that may puncture or lacerate the surface. Surface performance may be affected.
 - The sleep surface should be regularly inspected for such damage.
- **Warning**—The **Progressa** air surfaces will work most effectively when air circulation to the patient's skin is unimpeded. Avoid use of plastic linen savers or plastic-lined incontinence pads which obstruct air flow and permit moisture to remain in contact with the skin for prolonged periods of time, contributing to skin breakdown. Any incontinence pads or bed-protecting

linens used in conjunction with these surfaces should be highly absorbent and air permeable. Failure to follow this guidance could interfere with surface efficacy and cause injury.

- **Warning**—If the surface has an **MCM** topper, make sure it is installed before a patient is put on the bed.

FLAMMABILITY

To help prevent the risk of hospital bed fires, make sure facility personnel follow the safety tips in the *FDA Public Health Notification: Practice Hospital Bed Safety*. (US only).

Reduce the possibility of fires by observing fire prevention rules and regulations.



WARNING:

Warning—Patients should not be allowed to smoke in bed. Sheets and pillows generally do not have flame retardance properties. Injury could occur.

BED ARTICULATIONS

Do not operate bed controls until all persons and equipment are clear of mechanisms. To stop a function: release the control, and/or activate the opposite function, and/or immediately unplug the power cord.



WARNING:

Warning—To help prevent injury and/or equipment damage, obey these **warnings**:

- **Warning**—Observe lines closely during articulations. Always use good line management techniques, particularly as the head section rises.
- **Warning**—When routing cables from other equipment in the MEDICAL BED, precautions shall be taken to avoid squeezing those between parts of the MEDICAL BED.

VISITOR NOTIFICATION

Instruct visitors not to attempt operation of caregiver controls. They may assist the patient with patient controls.

PATIENT TRANSFER



WARNING:

Warning—Use hospital safe handling protocols when transferring a patient from one surface to another (such as the bed to a stretcher). Failure to do so could cause injury.

Progressa air surfaces—Use the Max-Inflate/P-Max Inflate surface mode to maximize the firmness of the surface to assist in patient surface-to-surface transfers.

TRACTION EQUIPMENT



WARNING:

Warning—Evaluate patients for entrapment and asphyxiation risk according to facility protocol, and monitor patients appropriately. Failure to do so could cause serious injury or death.

INTELLIDRIVE TRANSPORT SYSTEM BATTERIES



CAUTION:

Caution—To help prevent equipment damage, obey these **cautions**:

- **Caution**—If the bed is disconnected from mains power for longer than 6 months, and the **IntelliDrive** Transport System is installed and not activated, transport system battery performance may be affected.
 - If the bed is disconnected from mains power for longer than 6 months, and the bed has the **IntelliDrive** Transport System installed and not activated, reduced battery performance, to include the inability to charge, may result. Disconnect the bed battery and **IntelliDrive** Transport System batteries for periods of storage longer than 6 months.
- **Caution**—If the bed is disconnected from mains power for longer than 4 days, and the **IntelliDrive** Transport System is installed and activated, transport system battery performance may be affected.
 - If the bed is disconnected from mains power for longer than 4 days, and the bed has the **IntelliDrive** Transport System installed and activated, reduced transport system battery performance, including the inability to charge, may result.

LARGE PATIENT PRODUCT PERFORMANCE

The following bed functions may have reduced performance with patients who are near the maximum patient weight or height for the product:

- Turn Assist—Less turn capability
- Rotation Therapy—Less turn capability
- Percussion and Vibration Therapy—Less effective
- Bed Up and Down—Slower speed while you raise the bed
- Head Up and Down—Slower speed while you raise the head section
- Knee Up and Down—Slower speed while you raise the knee section
- **IntelliDrive** Transport System—Slower acceleration and speed
- C-Arm Compatibility—Imaging device may not be large enough for bed and patient

ATMOSPHERIC PRESSURE PRODUCT PERFORMANCE

The following surface functions may have reduced performance at higher altitudes:

- Percussion and Vibration Therapy—Less effective
- Other Inflation Functions—Slower achieving maximum level

PREVENTIVE MAINTENANCE



WARNING:

Warning—To help prevent injury and/or equipment damage, obey these **warnings**:

- **Warning**—Only facility-authorized personnel should perform calibration on the **Progressa** Bed.
- **Warning**—Only facility-authorized personnel should perform preventive maintenance on the **Progressa** Bed.

The **Progressa** Bed requires an effective maintenance program. We recommend that you perform annual preventive maintenance (PM) and testing for Joint Commission certification. PM and testing not only meet Joint Commission requirements but can help support a long, operative life for the **Progressa** Bed. PM will minimize downtime due to excessive wear. For the preventive maintenance detailed procedures, refer to the **Progressa and Progressa+ Bed Service Manual** (171748).

Perform annual preventive maintenance procedures to make sure all bed components are functioning as originally designed. Pay particular attention to safety features, including but not limited to:

- Siderail latching mechanisms
- Siderail dampers for oil leaks
- Caster braking systems
- Electrical system components
- Electrical power cords for fraying, damage, and proper grounding
- All controls return to off or neutral position when released
- Controls or cabling entanglement in system mechanisms or siderails
- Proper operation of the lockout controls
- Integrity of sleep surface cover
- Intake/Exhaust filters for cleanliness and condition

Main Battery

Replace the battery if any of these conditions exist (refer to the **Progressa and Progressa+ Bed Service Manual** (171748)):

- The battery indicator does not come on within 3 minutes of bed connection to AC mains.
- The battery indicator does not increase the number of illuminated LEDs within 12 hours of bed connection to AC mains.

IntelliDrive Transport System Batteries

Replace the batteries if the **IntelliDrive** Transport System automatically shuts down power before the final battery charge indication LED flashes (refer to the **Progressa and Progressa+ Bed Service Manual** (171748)).

Press the blue button on the end of the drive box to disable the battery if the bed will be stored for an extended period of time.

After replacing the batteries, charge the batteries a minimum of 20 hours before use.

NOTE:

Follow instructions on the batteries for proper disposal or recycling.

Troubleshooting



WARNING:

Warning—Only facility-authorized personnel should troubleshoot the **Progressa** Bed. Troubleshooting by unauthorized personnel could cause injury or equipment damage.

Always check the battery charge status on the siderail. The bed may not be functioning due to the battery being drained, and the bed needing to be plugged into its appropriate power source.

POWER CONSERVATION

The **Progressa** Bed has the means to reduce the use of electricity. The GCI screen automatically dims to reduce the use of electricity, and when there is no patient on the bed, the compressor will not cycle power as often.

The bed can also be placed in a transport mode to conserve AC power.

TRANSPORTATION MODE

When the transportation mode is activated, the articulation controls are disabled on battery power.

To Activate

1. On the intermediate siderail controls, press and hold the **Lockout** control for approximately 10 seconds. A triple beep sounds and the Service Required indicator illuminates to let you know the bed is in service mode.
2. On the patient controls (inside of the siderail), press and hold the **Knee Up** and **Knee Down** controls at the same time. A click will sound to let you know the bed is in transportation mode.

To Deactivate

If the bed is unplugged from AC power, on the patient controls (inside of the siderail), press and hold the **Head Up**, **Head Down**, and **Nurse Call** controls at the same time. A beep will sound to let you know the bed is no longer in transportation mode.

or

Plug the bed to AC power and the bed will come out of Transportation Mode after 30 minutes.

DECOMMISSIONING AND DISPOSAL INSTRUCTIONS

Customers should adhere to all federal, state, regional, and/or local laws and regulations as it pertains to the safe disposal of medical devices and accessories. If in doubt, the user of the device shall first contact Hill-Rom Technical Support for guidance on safe disposal protocols.

- In order to ensure the safe handling and disposal of this product, follow all relevant warnings provided in the service manual regarding possible causes of injury when decommissioning a bed.
 - Always ensure that the bed is unplugged before decommissioning.
- The bed and its accessories should be cleaned and disinfected, as described in the instructions for use, before any other decommissioning activities.
- If the decommissioned bed or accessory is still fit for use, Hill-Rom recommends donating the decommissioned bed and accessories to a charitable organization so that they can be reused.
- If the decommissioned bed or accessory is not fit for use, Hill-Rom recommends dismantling the bed in accordance with the instructions provided in the service manual. Hill-Rom recommends that all oil and hydraulic fluids are removed from the product before recycling or disposal, if applicable.

- Always check and comply with all local and national regulations and facility protocols when decommissioning a product.



Batteries should be recycled. Never dispose of batteries which contain substances that can be dangerous for the environment and health.



Other components, such as electronic components, plastics and metals, are recyclable in many local jurisdictions. Hill-Rom recommends recycling all components that can be recycled locally.

Components which cannot be recycled can be disposed of via standard waste disposal procedures.

EXPECTED LIFE

The expected life of a **Progressa** Bed is 10 years of normal use provided that recommended preventive maintenance is performed by the facility. However certain components have a shorter life cycle and will need to be replaced in order for the bed to meet its expected life. They are listed below:

- Beds with **IntelliDrive** Transport System—the transport system batteries have a 3 year life expectancy.
- Bed batteries have a 3 year life expectancy.
- Integrated bed surfaces (not including surface top cover) have a 5 year life expectancy.
- Blower motor has a 30,000 hour life expectancy.
- The removable mattress cover has a 2 year life expectancy.

CLEANING/DISINFECTING

NOTES:

- These cleaning and disinfecting instructions are for surface models P7520 and P7525. To determine which surface model you have, look at the surface product label at the head end of the surface. If the surface model number is P7540, see the **Progressa+ Bed Instructions for Use** (216321).
- The method to how to clean the surface is the same for all surfaces.

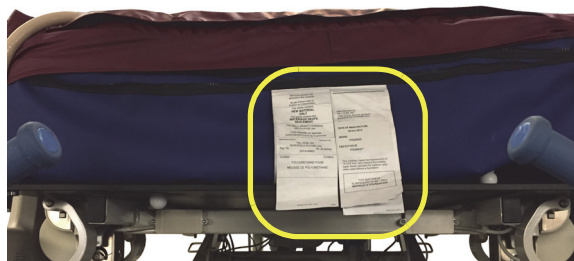

WARNING:

Warning—To help prevent injury and/or equipment damage, obey these **warnings**:

- **Warning**—Improper cleaning and disinfection could result in patient infection. Clean and disinfect between patient use.
- **Warning**—The potential for electrical shock exists with electrical equipment. Failure to follow facility protocol could cause death or serious injury.



WARNING:

Warning—(Warnings continued) Obey all **warnings** throughout the manual. Failure to do so could cause injury and or equipment damage:

- **Warning**—Whenever a bed is being cleaned or serviced, it should be unplugged from its power source, and the lockouts should be activated to keep the bed from accidentally operating due to the battery backup.
- **Warning**—Do not reuse wiping material for multiple steps or on multiple products.
- **Warning**—Harmful cleaning solutions may cause skin rash and/or irritation upon contact. Follow the manufacturer's instructions found on the product label and Safety Data Sheet (SDS).
- **Warning**—Lift and move items correctly. Do not twist, and seek assistance when necessary. Make sure the bed is at a correct height to lift items off the bed.
- **Warning**—Fluid spills on to the bed electronics could cause a hazard. If such a spill occurs, unplug the bed and remove it from service. When fluid spills occur outside of what is seen in normal use, immediately do as follows:
 - a. Unplug the bed from its power source.
 - b. Remove the patient from the bed.
 - c. Clean the fluid spill from the bed system.
 - d. Have maintenance examine the system completely.
 - e. Do not put the bed back into service until it is completely dry, tested, and found to be safe to operate.



CAUTION:

Caution—To help prevent equipment damage, obey these **cautions**:

- **Caution**—Do not steam clean or power wash the bed or mattress (surface). Pressure and excessive moisture can damage protective surfaces of the bed and its electrical components.
- **Caution**—Do not use harsh cleansers/detergents, heavy duty grease removers, solvents such as toluene, xylene, or acetone, and do not use scouring pads (you may use a soft bristle brush).
- **Caution**—Do not use bleach as your primary everyday cleaner/disinfectant.
- **Caution**—Fully extend the foot section prior to the cleaning and disinfection process.

RECOMMENDATIONS

For proper cleaning and disinfection, staff members should be trained.

The **trainer** should carefully read the instructions and follow them when the **trainee** is being trained. The trainee should:

- Be given time to read the instructions and to ask any questions.
- Clean and disinfect the product while the trainer supervises. During, and/or after this process, the trainer should correct the trainee of any differences from the instructions for use.

The trainer should supervise the trainee until the trainee can clean and disinfect the bed as instructed.

Hill-Rom recommends to clean and disinfect the bed and surface before first patient use, between patient use, and regularly during extended patient stays.

Some fluids used in the hospital environment, such as iodophor and zinc oxide creams, can cause permanent stains. Remove temporary stains by wiping vigorously with a lightly-dampened wiping cloth.

CLEANING AND DISINFECTION

Cleaning and disinfection are distinctly different processes. **Cleaning** is the physical removal of visible and non-visible soil and contaminants. **Disinfection** is intended to kill microorganisms.

Table 1 below summarizes the approved cleaners/disinfectants for use with the associated contact time for disinfection.

Table 1: Approved Cleaners/Disinfectants

Cleaner/Disinfectant	Recommended for Routine Cleaning and Disinfection	Recommended for Disinfection against Clostridium Difficile (C.Diff)	Maintain Wetness (Disinfection Contact Time)
Wex-Cide Germicidal Detergent ready-to-use	Yes	No	10 minutes
Virex II 256 Disinfectant Cleaner	Yes	No	10 minutes
OxyCide Daily Disinfectant Cleaner	Yes	Yes	3 minutes
Oxivir Tb	Yes	No	10 minutes
CaviCide Disinfectant Cleaner	Yes	No	3 minutes
Clorox HealthCare Bleach Germicidal Cleaner ready-to-use	No*	Yes	5 minutes
Clorox HealthCare Bleach Germicidal Wipes	No*	Yes	3 minutes

*Bleach is not recommended as the primary cleaner/disinfectant.

Remove any disinfectant residue prior to and after the use of bleach with a new or clean cloth/wipe soaked in tap water.

NOTE:

Not all cleaners and disinfectants listed in Table 1 may be approved for sale in your country. Always refer to the local regulations for applicable approved, listed in Table 1, cleaners and disinfectants. For questions, contact your Hillrom representative.

When you perform the detailed cleaning steps, please note the following:

- A microfiber cloth or ready-to-use is recommended as the wiping cloth.
- Always replace the wiping cloth when visibly soiled.
- Always replace the wiping cloth between steps (spot clean, clean, and disinfect).
- Always use Personal Protective Equipment (PPE).
- Adjust the bed position, siderails, headboard, and footboard as needed for ease of cleaning and disinfection.

Prepare the Bed for Cleaning and Disinfection

- a. Fully extend the foot section.
- b. Unplug the bed.

STEP 1: Cleaning

- a. As necessary, first remove visible soil from the bed and the surface using a wiping cloth soaked with an approved cleaner/disinfectant (see page 107).
 - Give special attention to seam surfaces and other areas where soil may accumulate.
 - A soft bristle brush may be used to loosen hardened soil.
 - Use as many wiping cloths as needed to remove the soil.

NOTE:

Laundry can be used as a **pre-cleaning** step on some **Progressa** top surface cover. Launder the cover, then follow the Cleaning and Disinfection instructions. See "Laundry Guidelines" on page 110.

It is important to remove all visible soil from all areas before continuing to remove non-visible soil.

- b. With a new wiping cloth soaked in an approved cleaner/disinfectant, use firm pressure to wipe all surfaces of the bed and the surface (including laundered covers, if applicable). Use a new or clean wiping cloth as often as necessary. Make sure the following items are cleaned:
 - Siderails
 - Headboard and footboard
 - Areas between the footboard and surface, headboard and surface, and siderails and surface.
 - Upper frame
 - Base frame
 - Power cord
 - Patient pendant (handheld remote) and pendant cord
 - Accessories
 - Surface - top and bottom
 - To raise the surface to clean underneath, find the surface retention knobs on the underside of the surface, and slide the knobs to the center of bed.
 - Clean the retention knobs.



- Fold the surface over toward the head end, and clean the interface connector assembly and the surface sleeve area. Do not disconnect the connector.



- Clean the underside of the flap that covers the zipper.



- If applicable, clean the x-ray sleeve.



- c. Examine the following for damage:
 - Top surface cover
 - Bottom surface cover and white attachment knobs
 - Zipper closures
- d. The damaged items should be replaced.

STEP 2: Disinfection

- a. With a new or clean wiping cloth soaked in an approved cleaner/disinfectant, use light pressure to wipe all exterior surfaces of the bed previously cleaned.
- b. Make sure all surfaces **remain wet with the cleaner/disinfectant** for the **specified contact time**. **Re-wet** surfaces with a new wiping cloth as necessary. See page 107 for the contact time.

NOTE:

If bleach is used with another cleaner/disinfectant, use a new or clean cloth/wipe soaked in tap water to remove any disinfectant residue prior to and after the bleach application.

- c. Allow the surface to air dry completely before you put the bed back in service.

Prepare the Bed for Use

- a. Connect the surface retention knobs at the head and foot ends of the surface.
- b. Plug the bed into an applicable power outlet.

LAUNDRY GUIDELINES

Laundry can be used as a **pre-cleaning** step for the top cover of the Therapy and Pulmonary Surfaces. Launder the cover, then follow the Cleaning and Disinfection instructions.

NOTES:

- The top cover of these surfaces can **not** be laundered:
 - Prevention
 - Essential
 - Advance
 - Accelerate
- Do **not** use bleach.

Machine wash the top cover as follows:

- a. Unzip and remove the top cover from the surface. Make sure to remove the **MCM** layer from the top cover.

NOTE:

The zipper tabs are located on the left side at the head end of the surface.

- b. Machine wash the top cover per your facility protocol. The cover can be washed at a maximum water temperature of 54°C (130°F).
- c. Use the lowest temperature setting of the dryer to dry the top cover; do not exceed 43°C (110°F).
- d. Follow the Cleaning and Disinfecting instructions. See “Cleaning and Disinfection” on page 107. Use a disinfectant as instructed in the manufacturer’s instructions.
 - To determine the amount of disinfectant to use, determine the amount of water in the washer, and follow the manufacturer’s dilution instructions.
 - During the wash cycle, soak the top cover in the disinfectant.
 - Let the top cover rinse thoroughly in clean water.
- e. For **rental** beds, Hill-Rom Service personnel will follow the Laundry Wash and Dry Procedure (QS02040).

TECHNICAL SPECIFICATIONS

Product Identification

Product Number	Description
P7500	Progressa Bed—refer to “Product Configuration Identification” on page 129 for configurations.
Progressa+ Accelerate Surfaces	
P7540A0010000	Progressa+ Accelerate Surface
P7540A0011000	Progressa+ Accelerate ALP Surface
P7540A0020000	Progressa+ Accelerate Surface
P7540A0021000	Progressa+ Accelerate ALP Surface
P7540A0110000	Progressa+ Accelerate StayInPlace Surface
P7540A0111000	Progressa+ Accelerate ALP StayInPlace Surface
P7540A0120000	Progressa+ Accelerate StayInPlace Surface
P7540A0121000	Progressa+ Accelerate ALP StayInPlace Surface
P7540A0121R00	Progressa+ Accelerate ALP StayInPlace Surface Rental
Progressa+ Advance Surfaces	
P7540A0000000	Progressa+ Advance Surface
P7540A0001000	Progressa+ Advance ALP Surface
P7540A0100000	Progressa+ Advance StayInPlace Surface
P7540A0101000	Progressa+ Advance ALP StayInPlace Surface

Specifications for Progressa Bed

Feature	Dimension
Total Length—foot section extended	98" (2489 mm)*
Total Length—foot section retracted	88" (2235 mm)*
Maximum Width (siderails stored)	40.5" (1029 mm)
Maximum Width (siderails up)	40.5" (1029 mm)
Maximum Siderail Height above sleep deck	17" (432 mm)
Minimum Underbed Clearance (without IntelliDrive Transport System)	4.3" (109 mm)
Minimum Underbed Clearance (with IntelliDrive Transport System)	1.1" (28 mm) (approximate)
Caster Size	6" (152 mm)
Total Weight—includes maximum SWL and frame weight	1400 lb (635 kg)
Head Section Inclination (maximum)	67° for beds without Chair Egress 77° for beds with Chair Egress
Thigh Section Inclination (maximum)	30°
Foot Section Inclination (maximum)	45° beds without Chair Egress 75° beds with Chair Egress
Trendelenburg Position (maximum)	13°
Reverse Trendelenburg Position (maximum)	18°
Safe Working Load—includes patient weight, surface and accessories	650 lb (295 kg)
Patient weight	70 to 500 lb (32 to 227 kg)
Patient height	59" to 74" (150 to 188 cm)
Progressa Prevention or Essential Surface Dimensions:	
Surface Width x Length x Thickness	35" x 84" x 7.125" (889 x 2133.6 x 181 mm)
Surface Weight	31 lb (14 kg)
Progressa Therapy Surface Dimensions:	
Surface Width x Length x Thickness	35.5" x 84" x 8" (901.7 x 2133.6 x 203.2 mm)
Surface Weight	45 lb (20.4 kg)
Progressa Pulmonary Dimensions:	
Surface Width x Length x Thickness	35.5" x 84" x 8" (901.7 x 2133.6 x 203.2 mm)
Surface Weight	48 lb (21.8 kg)
Progressa+ Advance Surface Dimensions:	
Surface Width x Length x Thickness	35.5" x 84" x 9" (901.7 x 2133.6 x 228.6 mm)
Surface Weight	60 lb (27.2 kg)
Progressa+ Accelerate Surface Dimensions:	
Surface Width x Length x Thickness	35.5" x 84" x 9" (901.7 x 2133.6 x 228.6 mm)
Surface Weight	65 lb (29.5 kg)
Headboard Weight	6.6 lb (3 kg)
Footboard Weight	14.8 lb (6.7 kg)**

*The Transport Shelf will add 1.5" (3.8 cm) to the total length.

**The Transport Shelf will add 7 lb (3.2 kg) to the total weight.

Bed Dimensions

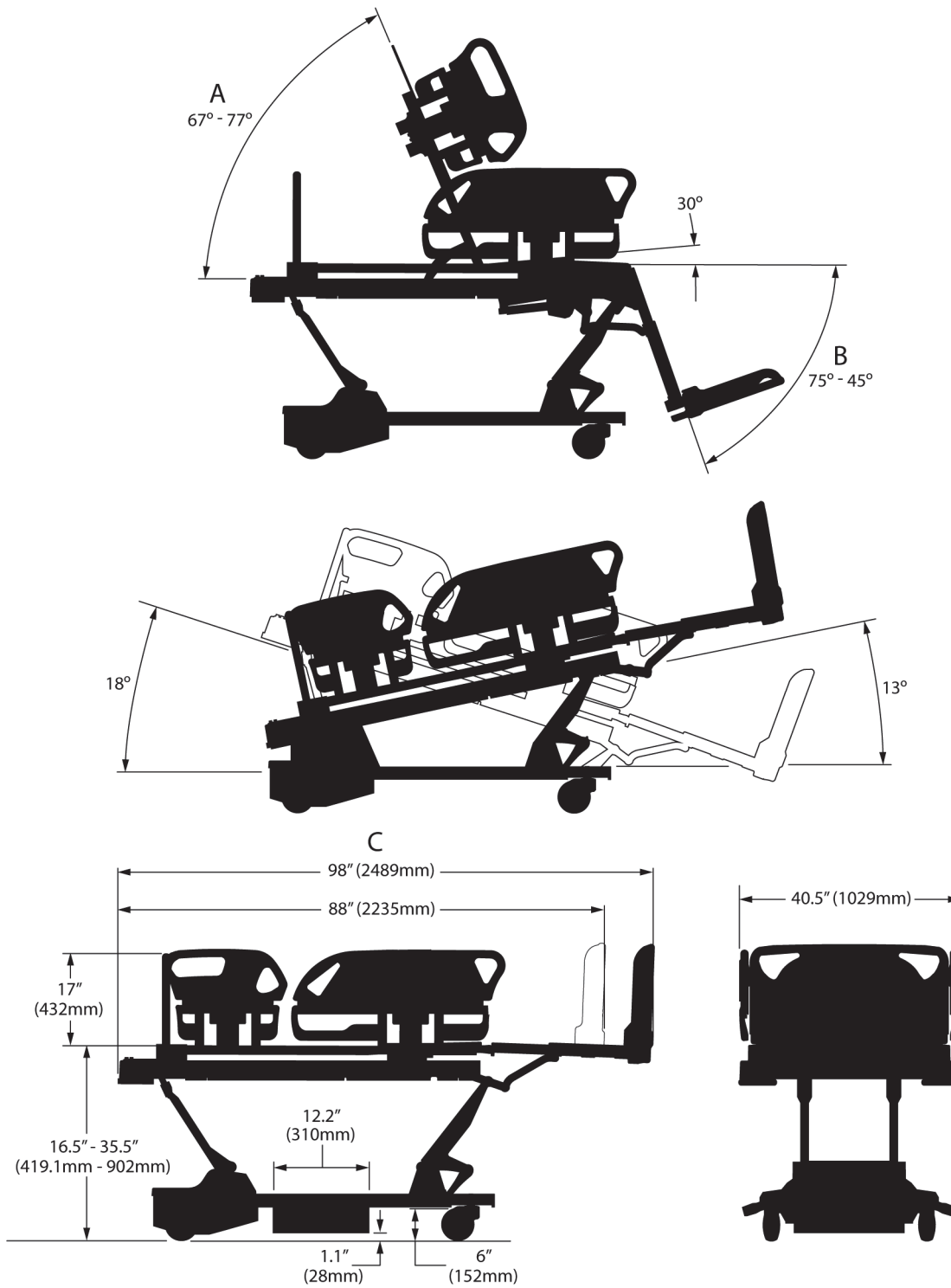

Bed Dimensions Notes

Callout	Note
A	67° without Chair Egress or 77° with Chair Egress
B	45° without Chair Egress or 75° with Chair Egress
C	The Transport Shelf adds 1.5" (3.8 cm) to the total length

Environmental Conditions for Transport and Storage

Condition	Range
Temperature	-20°F (-29°C) to 140°F (60°C)
Relative Humidity	15 to 90%
Pressure	500 hPa to 1060 hPa

Environmental Conditions for Use

Condition	Range
Ambient Temperature— Progressa Prevention Surface	50° F to 104° F (10° C to 40° C)
Ambient Temperature— Progressa Therapy and Pulmonary Surfaces	50° F to 86° F (10° C to 30° C)
Relative Humidity Range	20% to 85% non-condensing
Atmospheric Pressure	70 kPa to 106 kPa
Altitude	Medical electric equipment rated to operate at an altitude of less than 9842.5' (3000 m)

Mains Power Requirements

Condition	Range
Rated Voltage	100 V/110 V/115 V/120 V/127 V/220 V/230 V/240 V AC
Power/Input	6 A (220 V, 230 V, and 240 V beds) 10 A (100 V, 110 V, 120 V, and 127 V beds)
Frequency	60/50 Hz (all beds)

Fuse Specifications

Condition	Range
Air System Fuse (air system optional)	6.3 A, 250 V~, 5 x 20 mm, UL 248-1 Slo-Blo or equivalent
Battery Fuse	10 A, 32 V~, ATO
Mains Fuse (100V, 110V, 120V, and 127V bed model)	2 each 15 A, 250 V~, ¼" x 1¼", UL 248-1 Slo-Blo or equivalent
Mains Fuse (220V, 230V, and 240V bed model)	6.3 A, 250 V~, 5 x 20 mm, IEC127 Sheet III, Time Delay

Auxiliary Outlet Power Specifications

Condition	Range
Receptacle	12 A outlet, electrically isolated from the bed's mains power (120 VAC beds)

Applied Parts (in accordance with IEC 60601-1)

Siderail	Headboard
Footboard	Caregiver Pendant
Sleep deck	Sleep surface
Line manager	Head extension
Proning accessory	

Scale Classification (European Scale Beds Only)

Condition	Range
Technical and Quality Standards	EN 45501
Classification per EN 45501	Class III

Nurse Call Connection Requirements

For information about the Nurse Call connection requirements, refer to the *SideCom Communication System Design and Application Manual (DS059)*. Contact the Nurse Call manufacturer to make sure the Nurse Call system is compatibility with the bed.

Surface Compatibility

Bed Configuration			Available Surface			
Dining Chair	Chair Egress	Chair Egress with StayInPlace Feature	Prevention	Therapy	Pulmonary (CLRT only)	Full Pulmonary (CLRT and P &V)
X			X	X	X	X
	X		X	X	X	X
		X	X	X	X	X



WARNING:

Warning—The **Envision** E700 surface on the **Progressa** Bed frame is not fully compliant to the IEC 60601-2-52:2009 standard; however, it is compliant with the FDA Guidance: Hospital Bed System Dimensional and Assessment Guidance to Reduced Entrapment [Issued March 10, 2006] standard. Use of a surface in combination with the product that is not fully compliant to the IEC 60601-2-52:2009 standard may increase the risk of patients becoming trapped. In such cases, the patient must be monitored closely.



WARNING:

Warning—The following surfaces can be used with the **Progressa** Bed with the **Dining Chair** feature option. Do not use the following surfaces with the Chair Egress option. Do not use the **FlexAfoot** feature with the following surfaces:

- P500 MRS
- NP100—flat deck 36" x 84" (91 cm x 213 cm)
- **AccuMax** Surface—flat deck 36" x 84" (91 cm x 213 cm)
- **Accella** Therapy **MCM** P006788A—flat deck 36" x 84" (91 cm x 213 cm)

Classification and Standards

The **Progressa** Bed is designed and manufactured according to the following equipment classifications and standards:

Technical and Quality Assurance Standards	ANSI-AAMI ES 60601-1 EN & IEC 60601-1 EN & IEC 60601-1-6 EN & IEC 60601-2-52 EN & IEC 62304 EN & IEC 62366 CAN/CSA-C22.2 No. 60601-1 CAN/CSA-C22.2 No. 60601-2-52 RoHS Directive 2011/65/EU as amended by (EU) 2015/863
Equipment Classification per EN 60601-1	Class I equipment, internally powered equipment
Degree of Protection Against Electric Shock	Type B
Classification According to Directive 93/42/EEC	Class Im Class IIa for therapy and pulmonary surfaces
Degree of Protection Against Ingress of Water	Ordinary Equipment - IPX4
Degree of Protection Against the Presence of Flammable Anesthetic Mixtures	Not for use with flammable anaesthetics.
Mode of Operation (Bed Articulation)	Continuous operation with intermittent loading, 2 minutes ON/18 minutes OFF
Sound Level	<65dBA
Application Environments	Environments-1, 2, 3, and 5 per EN and IEC 60601-2-52

Flammability Codes—United States, Canada, and Europe

All recommended support surfaces meet the applicable United States, Canadian, and European flammability specifications.

California Proposition 65 Warning:



WARNING:

Warning—This product can expose you to chemicals including Lead and Di (2-ethylhexyl) phthalate (DEHP), which are known to the State of California to cause cancer, and Lead and Di (2-ethylhexyl) phthalate (DEHP), which are known to the State of California to cause birth defects or other reproductive harm. For more information go to www.P65Warnings.ca.gov.

Electromagnetic Emissions Guidance



CAUTION:

Caution—This device meets all requirements for electromagnetic compatibility per IEC 60601-1-2. It is unlikely that the user will encounter problems with this device because of inadequate electromagnetic immunity. However, electromagnetic immunity is always relative, and standards are based on anticipated environments of use. If the user observes unusual device behavior, particularly if such behavior is intermittent and associated with nearby use of radio or TV transmitters, cell phones, or electro-surgical equipment, this could be an indication of electromagnetic-interference. If such behavior occurs, the user should try to move the interfering equipment further from this device.

Policies and procedures must be established to train and educate your staff on the risks associated with electric equipment. It is never prudent or necessary for personnel to place any part of their body under or between moving parts of the bed. Whenever a bed is being cleaned or serviced, it should be unplugged from its power source, and the lockouts should be activated to keep the bed from accidentally operating due to the battery backup. Refer to the **Progressa and Progressa+ Bed Service Manual** (171748).



WARNING:

Warning—The P7500 should not be used adjacent to or stacked with other electrical equipment. If adjacent or stacked use is necessary, observe the P7500 and the other electrical equipment to make sure they operate as intended.

Make sure the P7500 operates correctly when it is used near other electronic devices. Portable and mobile radio frequency (RF) communications equipment can affect electrical equipment.

Medical equipment needs special precautions in regard to electromagnetic compatibility (EMC) and needs to be installed and put into service according to the EMC information supplied in the tables that follow.

Guidance and Manufacturer's Declaration—Electromagnetic Emissions		
The P7500 is intended for use in the electromagnetic environment specified below. The customer or the user of the model P7500 should make sure it is used in such an environment.		
Emissions Test	Compliance	Electromagnetic Environment—Guidance
RF emissions CISPR 11	Group 1	The P7500 uses RF energy only for its internal functions. Therefore, its RF emissions are low and are not likely to cause any interference in nearby electronic equipment.
RF Emissions CISPR 11	Class A	The P7500 is suitable for use in all establishments other than domestic establishments and those directly connected to the public low-voltage power supply network that supplies buildings used for domestic purposes.
Harmonic Emissions IEC 61000-3-2	Class A	
Voltage Fluctuations/ Flicker Emissions IEC 61000-3-3	Complies	

NOTE:

The EMISSIONS characteristics of this equipment make it suitable for use in industrial areas and hospitals (CISPR 11 class A). If it is used in a residential environment (for which CISPR 11 class B is normally required) this equipment might not offer adequate protection to radio-frequency communication services. The user might need to take mitigation measures, such as relocating or reorienting the equipment.

Electromagnetic Immunity Guidance

Guidance and Manufacturer's Declaration - Electromagnetic Immunity			
The P7500 is intended for use in the electromagnetic environment specified below. The customer or the user of the P7500 should make sure it is used in such an environment.			
Immunity Test	EN and IEC 60601-1-2 4th Edition Test Level	Compliance Level	Electromagnetic Environment—Guidance
Electrostatic Discharge (ESD) IEC 61000-4-2	± 8 kV Contact ± 15 kV Air	± 8 kV Contact ± 15 kV Air	Floors should be wood, concrete, or ceramic tile. If floors are covered with synthetic material, the relative humidity should be at least 30%.
Electrical Fast Transient (EFT) IEC 61000-4-4	± 2 kV for Power Supply Lines (100 kHz Repetition Frequency)	± 2 kV for Power Supply Lines (100 kHz Repetition Frequency)	Mains power quality should be that of a typical commercial or hospital environment.
Surge IEC 61000-4-5	± 1 kV Line(s) to Line(s) ± 2 kV Line(s) to Earth	± 1 kV Line(s) to Line(s) ± 2 kV Line(s) to Earth	Mains power quality should be that of a typical commercial or hospital environment.
Voltage Dips, IEC 61000-4-11 (See Note 1)	0% U_T for 0.5 cycles at 0°, 45°, 90°, 135°, 180°, 225°, 270°, and 315° (for single-phase mains equipment)	0% U_T for 0.5 cycles at 0°, 45°, 90°, 135°, 180°, 225°, 270°, and 315° (for single-phase mains equipment)	Mains power quality should be of a typical commercial or hospital environment. If the user of the P7500 requires continued operation during power mains interruption, it is recommended that the P7500 be powered from an uninterruptible power supply or a battery.
	0% U_T for one cycle 70% U_T for 25/50 Hz and 30/60 Hz cycles	0% U_T for one cycle 70% U_T for 25/50 Hz and 30/60 Hz cycles	
Voltage Interruptions IEC 6100-4-11 (See Note 1)	0% U_T for 250/50 Hz and 300/60 Hz cycles	0% U_T for 250/50 Hz and 300/60 Hz cycles	
Power Frequency (50/60hz) Magnetic Fields IEC 61000-4-8	30 A/m	30 A/m	Power frequency magnetic fields should be at levels characteristic of a typical location in a typical commercial or hospital environment.
Note 1: U_T is the AC mains voltage prior to application of the test level.			

Electromagnetic Immunity Guidance

Guidance and Manufacturer's Declaration - Electromagnetic Immunity			
The P7500 is intended for use in the electromagnetic environment specified below. The customer or the user of the P7500 should make sure it is used in such an environment.			
Immunity Test	EN and IEC 60601-1-2 4th Edition Test Level	Compliance Level	Electromagnetic Environment—Guidance
Conducted RF-Immunity IEC 61000-4-6	3 V (80% AM) 150 kHz to 80 MHz (6V in ISM Bands per CISPR-11)	3 V (80% AM) 150 kHz to 80 MHz (6V in ISM Bands per CISPR-11)	Field strengths from fixed RF transmitters, as determined by an electromagnetic site survey, should be less than the compliance level in each frequency range.
Radiated RF-Immunity IEC 61000-4-3	3 V/m 80 MHz to 2700 MHz	10 V/m 80 MHz to 2700 MHz	Interference may occur in the vicinity of equipment marked with this symbol. 
<p>Note 2: These guidelines may not apply in all situations. Electromagnetic propagation is affected by absorption and reflection from structures, objects and people.</p> <p>Note 3: Field strengths from fixed transmitters, such as base stations for radio (cellular/cordless) telephones and land mobile radios, amateur radio, AM and FM radio broadcast and TV broadcast can not be predicted theoretically with accuracy. To assess the electromagnetic environment due to fixed RF transmitters, an electromagnetic site survey should be considered. If the measured field strength in the location in which the P7500 is used exceeds the applicable RF compliance level above, the P7500 should be observed to verify normal operation. If abnormal performance is observed, additional measures may be necessary, such as reorienting or relocating the P7500.</p>			

IMMUNITY to Proximity Fields from Radio Frequency Wireless Communications Equipment						
In addition to the Radiated RF IEC 61000-4-3 as shown in the table above, the P7500 has been tested as specified in the table below.						
Test Frequency (MHz)	Band (MHz)	Service	Modulation	Maximum Power (W)	Distance (m)	Immunity Test Level (V/m)
385	380-390	TETRA 400	Pulse modulation 18 Hz	1,8	0,3	27
450	430-470	GMRS 460, FRS460	FM ± 5 kHz deviation 1 kHz sine	2	0,3	28
710	704-787	LTE Band 13, 17	Pulse modulation 217 Hz	0,2	0,3	9
745						
780						
810	800-960	GSM 800/900 TETRA 800, iDEN 820, CDMA 850, LTE Band 5	Pulse modulation 18 Hz	2	0,3	28
870						
930						

1720	1700-1990	GSM 1800; CDMA 1900; GSM 1900; DECT; LTE Band 1,3, 4, 25; UMTS	Pulse modulation 217 Hz	2	0,3	28
1845						
1970						
2450	2400-2570	Bluetooth WLAN, 802.11 b/g/n, RFID	Pulse modulation 217 Hz	2	0,3	28
5240	5100-5800	WLAN 802.11 a/n	Pulse modulation 217 Hz	0,2	0,3	9
5500						
5785						

Recommended Separation Distances between Portable and Mobile RF Communications Equipment and the P7500 Model			
The P7500 is intended for use in an electromagnetic environment in which radiated RF disturbances are controlled. The customer or the user of the P7500 can help prevent electromagnetic interference by maintaining a minimum distance between portable and mobile RF communications equipment (transmitters) and the P7500 as recommended below, according to the maximum output power of the communications equipment.			
Rated maximum output power of transmitter, W	Separation distance according to frequency of transmitter, m		
	150 kHz to 80 MHz $d = 1.2\sqrt{P}$	80 MHz to 800 MHz $d = 1.2\sqrt{P}$	800 MHz to 2.5 GHz $d = 2.33\sqrt{P}$
0.01	0.12	0.12	0.23
0.1	0.38	0.38	0.73
1	1.2	1.2	2.3
10	3.8	3.8	7.3
100	12	12	23
For transmitters rated at a maximum output power not listed above, the recommended separation distance d in metres (m) can be estimated using the equation applicable to the frequency of the transmitter, where P is the maximum output power rating of the transmitter in watts (W) according to the transmitter manufacturer. NOTE 1: At 80 MHz and 800 MHz, the separation distance for the higher frequency range applies. NOTE 2: These guidelines may not apply in all situations. Electromagnetic propagation is affected by absorption and reflection from structures, objects and people.			

WIRELESS CONNECTIVITY SPECIFICATIONS—EXTERNAL WIRELESS MODULE

If the bed is equipped with a wireless module, it will be with an external wireless module or an internal wireless module. To determine which module the bed is equipped with, see “Module Location Option” on page 65.

NOTE:

The External Wireless Module is a separate module which has a separate Radio Transmission Equipment Type Approval Certificate.

General Wireless Recommendations

The following are general best practice recommendations for establishing durable wireless connections between the Hillrom Radio and the customer’s wireless network:

Received Signal Strength Indication (RSSI)	Hillrom highly recommends a primary RSSI Value of better than or equal to -67dBm and a secondary wireless signal of -70dBm or better over the coverage area. For proper Tx/Rx balance, RSSI readings should apply when APs are transmitting at 25mW or less. The device radio transmits on average up to 25mW power, limited by Regulatory Domain restrictions. The AP signal strength and radio signal strength must be balanced, if not, dropped packets and loss of connectivity can result.
Signal to Noise Ratio (SNR)	≥15dB. High noise level may cause dropped packets.
Jitter	Packet-to-Packet jitter should be ≤400ms.
DTIM	Set DTIM value to 1 (Wireless Controller default) for best performance.
SSID/WLAN Settings	<ul style="list-style-type: none"> • Enable Session Timeout = Disabled • Client Load Balancing = Disabled • Client Band Select = Disabled

Wireless Connectivity Specifications

The Wireless Connectivity module supports these security protocols:

Standards

- Wired Equivalent Privacy (WEP)
- Wireless Protected Access (WPA)
- IEEE 802.11i (WPA2)

Encryption

The Wireless Connectivity module supports these encryption protocols:

- Wired Equivalent Privacy (WEP, RC4 Algorithm)
- Temporal Key Integrity Protocol (TKIP, RC4 Algorithm)
- Advanced Encryption Standard (AES, Rijndael Algorithm)
- Encryption Key Provisioning Static (40-bit and 128-bit lengths)
- Pre-Shared (PSK)
- Dynamic 802.1X

Encryption Options

- Off
- On
- Auto
- PSK
- WPA-TKIP
- WPA2-PSK
- WPA2-AES
- CCKM-TKIP
- CCKM-AES
- WPA-PSK-AES
- WPA-AES

Extensible Authentication Protocol Types (EAP Types)

- PEAP-MSCHAP
- PEAP-GTC

Wireless System Characteristics

Characteristic	Description
Frequency Band—2.4 GHz	FCC: 2.4 GHz to 2.483 GHz ETSI: 2.4 GHz to 2.483 GHz MIC: 2.4 GHz to 2.495 GHz KC: 2.4 GHz to 2.483 GHz
Frequency Band—5GHz	FCC: 5.15 GHz to 5.35 GHz, 5.725 GHz to 5.825 GHz ETSI: 5.15 GHz to 5.35 GHz, 5.47 GHz to 5.725 GHz MIC: 5.15 GHz to 5.35 GHz, 5.47 GHz to 5.725 GHz (W56) KC: 5.15 GHz to 5.25 GHz, 5.725 GHz to 5.825 GHz
Modulation	BPSK @ 1, 6, 6.5, 7.2, and 9 Mbps QPSK @ 2, 12, 13, 14.4, 18, 19.5, and 21.7 Mbps CCK @ 5.5 and 11 Mbps 16-QAM @ 24, 26, 28.9, 36, 39, and 43.3 Mbps 64-QAM @ 48, 52, 54, 57.8, 58.5, 65, and 72.2 Mbps
Network Standards	IEEE 802.11a, 802.11b, 802.11d, 802.11e, 802.11g, 802.11h, 802.11i, 802.11n
Data Rates Supported	802.11a (OFDM): 6, 9, 12, 18, 24, 36, 48, 54 Mbps 802.11b (DSSS, CCK): 1, 2, 5.5, 11 Mbps 802.11g (OFDM): 6, 9, 12, 18, 24, 36, 48, 54 Mbps 802.11n (OFDM, HT20, MCS 0-7): 6.5, 13, 19.5, 26, 39, 52, 58.5, 72.2 Mbps and 7.2, 14.4, 21.7, 28.9, 43.3, 57.8, 65 Mbps
Transmit Power Settings	802.11a: 6 Mbps 15 dBm 54 Mbps 13 dBm (PER - 10%) 802.11b: 1 Mbps 16 dBm 11 Mbps 16 dBm (PER - 10%) 802.11g: 6 Mbps 16 dBm 54 Mbps 14 dBm (PER - 10%) 802.11n (2.4 GHz): MCS0 Mbps 16 dBm MCS7 Mbps 12 dBm 802.11n (5 GHz): MCS0 Mbps 15 dBm MCS7 Mbps 12 dBm Bluetooth 2 dBm (1.58 mW) (Class 2)

WiFi and Bluetooth Radio Approval

Laird—WB45NBT	FCC ID: SQG-WB45NBT IC ID: 3147A-WB45NBT
Approved by ANRT Morocco	Approval Number: MR_30370_ANRT_2021 Approval Date: 2021_10_19

Regulatory Information

Changes and/or modifications not expressly approved by Hill-Rom Co., Inc. could void the user's authority to operate the equipment.

The module must be installed and used in accordance with the Hill-Rom user and installation instructions. Hill-Rom is not responsible for any radio or television interference caused by unauthorized modification of the devices included with the Hill-Rom module, or the substitution or attachment of connection cables and equipment other than that specified by Hill-Rom Co., Inc. The correction of interference caused by such unauthorized modification, substitution, or attachment is the responsibility of the user. Hill-Rom is not liable for any damage or violation of government regulations that may arise from the user failing to comply with these requirements.

USA—Federal Communications Commission (FCC) Radiation Exposure Statement



CAUTION:

Caution—The radiated output power of the module is below the FCC radio frequency exposure limits. The module must be used in such a manner that the potential for human contact during normal operation is minimized. To avoid the possibility to exceed the FCC radio frequency exposure limits, you should keep a distance of at least 8" (20 cm) between you (or any other person in the vicinity) and the antenna that is built into the wireless module.



Interference Statement for FCC

NOTE:

"Harmful interference" is defined by the FCC as follows: Any emission, radiation or induction that endangers the functioning of a radio navigation service or of other safety services or seriously degrades, obstructs, or repeatedly interrupts a radio communications service operating in accordance with FCC rules.

These devices comply with Part 15 of the FCC Rules. Operation of the devices is subject to these two conditions: (1) the devices may not cause harmful interference, and (2) the devices must accept any interference that may cause unwanted operation.

This equipment has been tested and found to comply with the limits for a Class A digital device, pursuant to Part 15 of the FCC Rules. These limits are designed to supply reasonable protection against harmful interference in a residential installation. This equipment generates, uses, and can radiate radio frequency energy. If the equipment is not installed and used in accordance with the instructions, the equipment may cause harmful interference to radio communications. There is no guarantee, however, that such interference will not occur in a particular installation. If this equipment does cause harmful

interference to radio or television reception (which can be determined by turning the equipment off and on), the user is encouraged to take one of these measures to try to correct the interference:

- Move this device.
- Increase the separation between the device and the receiver.
- Connect the device to an outlet on a circuit different from that of other electronics.
- Consult the dealer or an experienced radio technician for help.

NOTE:

The module must be installed and used in strict accordance with the manufacturer's instructions as described in the user documentation that comes with the product. Any other installation or use will violate FCC Part 15 regulations. Modifications not expressly approved by Hill-Rom could void your authority to operate the equipment.

The module must not be co-located or operated in conjunction with any other antenna or transmitter.

"Harmful Interference" is defined by the FCC as follows: Any emission, radiation, or induction that endangers the functioning of a radio navigation service, or of other safety services, or seriously degrades, obstructs, or repeatedly interrupts a radio communications service, operating in accordance with FCC rules.

Canada—Industry Canada (IC)

RF Radiation Hazard Warning

This device complies with RSS-247 of Industry Canada.

Operation is subject to these two conditions: (1) this device may not cause interference, and (2) this device must accept any interference, which include interference that may cause unwanted operation of this device.

The term "IC" before the equipment certification number only signifies that the Industry Canada technical specifications were met.

To prevent radio interference to the licensed service, this device is intended to be operated indoors and away from windows to provide maximum shielding. Equipment (or its transmit antenna) that is installed outdoors is subject to licensing.



CAUTION:

Caution—Exposure to Radio Frequency Radiation.

The installer of this radio equipment must make sure the antenna is located or pointed such that it does not emit an RF field in excess of Health Canada limits for the general population; consult Safety Code 6, obtainable from Health Canada's website <http://www.hc-sc.gc.ca/rpb>.

Using higher gain antennas and types of antennas not certified for use with the product is not allowed. The device shall not be co-located with another transmitter.

WIRELESS CONNECTIVITY SPECIFICATIONS—INTERNAL WIRELESS MODULE

If the bed is equipped with a wireless module, it will be with an external wireless module or an internal wireless module. To determine which module the bed is equipped with, see “Module Location Option” on page 65.

NOTE:

Internal Wireless Module is a separate module which has a separate Radio Transmission Equipment Type Approval Certificate.

General Wireless Recommendations

The following are general best practice recommendations for establishing durable wireless connections between the Hillrom Radio and the customer’s wireless network:

Received Signal Strength Indication (RSSI)	Hillrom highly recommends a primary RSSI Value of better than or equal to -67dBm and a secondary wireless signal of -70dBm or better over the coverage area. For proper Tx/Rx balance, RSSI readings should apply when APs are transmitting at 25mW or less. The device radio transmits on average up to 25mW power, limited by Regulatory Domain restrictions. The AP signal strength and radio signal strength must be balanced, if not, dropped packets and loss of connectivity can result.
Signal to Noise Ratio (SNR)	≥15dB. High noise level may cause dropped packets.
Jitter	Packet-to-Packet jitter should be ≤400ms.
DTIM	Set DTIM value to 1 (Wireless Controller default) for best performance.
SSID/WLAN Settings	<ul style="list-style-type: none"> • Enable Session Timeout = Disabled • Client Load Balancing = Disabled • Client Band Select = Disabled
Ports Open	<ul style="list-style-type: none"> • Remote Service Communication Server port 8883 • Remote Service Firmware Upgrade is handled through port 443
DHCP	<ul style="list-style-type: none"> • Enable DHCP option 42 and provide valid Network Time Protocol (NTP) server address during DHCP lease and renewal

Wireless Connectivity Specifications

The Wireless Connectivity module supports these security protocols:

Security Protocol: Wireless Equivalent Privacy (WEP)

Supported Authentication Options for WEP:

- Open (none)
- Pre-Shared (PSK)

Security Protocol: Wireless Protected Access (WPA)

Supported Authentication Options for WPA:

- Pre-Shared Key (PSK)
- Enterprise (802.1X)

Supported Encryption Option for WPA:

- Temporal Key Integrity Protocol TKIP

Security Protocol: Wireless Protected Access II (WPA2)

Supported Authentication Options for WPA2:

- Pre-Shared Key (PSK)
- Enterprise (802.1X)

Supported Encryption Options for WPA2:

- Advanced Encryption Standard (AES)

Supported Extensible Authentication Protocol (EAP)

- Types for 802.1X:
- PEAP-MSCHAPv2
- PEAP-GTC

NOTE:

The current firmware for the **Progressa** Beds WiFi (internal wireless module) interface does not support 802.11r fast transition authentication key management (AKM)—fast transition-pre-shared key (FT-PSK) or 802.1x-FT. Cisco/Meraki wireless local area networks (WLANs) on which **Progressa** Beds will be connected that use 802.11r must have their AKM modified to Fast Transition: Adaptive. For other WiFi vendors, please refer to their documentation for adaptive, fast transition AKM strategies.

Wireless System Characteristics

Characteristic	Description
Frequency Band—2.4 GHz	FCC: 2.4 GHz to 2.483 GHz ETSI: 2.4 GHz to 2.483 GHz MIC: 2.4 GHz to 2.495 GHz KC: 2.4 GHz to 2.483 GHz
Frequency Band—5GHz	FCC: 5.15 GHz to 5.35 GHz, 5.725 GHz to 5.825 GHz ETSI: 5.15 GHz to 5.35 GHz, 5.47 GHz to 5.725 GHz MIC: 5.15 GHz to 5.35 GHz, 5.47 GHz to 5.725 GHz (W56) KC: 5.15 GHz to 5.25 GHz, 5.725 GHz to 5.825 GHz
Modulation	BPSK @ 1, 6, 6.5, 7.2, and 9 Mbps QPSK @ 2, 12, 13, 14.4, 18, 19.5, and 21.7 Mbps CCK @ 5.5 and 11 Mbps 16-QAM @ 24, 26, 28.9, 36, 39, and 43.3 Mbps 64-QAM @ 48, 52, 54, 57.8, 58.5, 65, and 72.2 Mbps
Network Standards	IEEE 802.11a, 802.11b, 802.11d, 802.11e, 802.11g, 802.11h, 802.11i, 802.11n
Data Rates Supported	802.11a (OFDM): 6, 9, 12, 18, 24, 36, 48, 54 Mbps 802.11b (DSSS, CCK): 1, 2, 5.5, 11 Mbps 802.11g (OFDM): 6, 9, 12, 18, 24, 36, 48, 54 Mbps 802.11n (OFDM, HT20, MCS 0-7): 6.5, 13, 19.5, 26, 39, 52, 58.5, 72.2 Mbps and 7.2, 14.4, 21.7, 28.9, 43.3, 57.8, 65 Mbps
Transmit Power Settings	802.11a: 6 Mbps 15 dBm, 54 Mbps 13 dBm (PER - 10%) 802.11b: 1 Mbps 16 dBm, 11 Mbps 16 dBm (PER - 10%) 802.11g: 6 Mbps 16 dBm, 54 Mbps 14 dBm (PER - 10%) 802.11n (2.4 GHz): MCS0 Mbps 16 dBm MCS7 Mbps 12 dBm 802.11n (5 GHz): MCS0 Mbps 15 dBm, MCS7 Mbps 12 dBm

WiFi and Bluetooth Radio Approval

Variscite Module— VS10R5MN1ME8GAEDCL1	Texas Instruments Module— WL18 MODGI	FCC ID: Z64-WL18DBMOD IC ID: 4511-WL18DBMOD
--	---	--



WARNING:

Warning—To help prevent injury and/or equipment damage, obey these **warnings**:

- Connection of the **Progressa** Bed to an IT Network that includes other equipment could result in unidentified patient injury, equipment damage, and/or third parties.
- Subsequent change to the IT network could introduce new risks and additional analysis.
- Changes to the IT network including the following:
 - Change to the IT network configuration
 - Connection of additional items to the IT network
 - Disconnecting items from the IT network
 - Upgrade of equipment connected to the IT network

Regulatory Information

Changes and/or modifications not expressly approved by Hill-Rom Co., Inc. could void the user's authority to operate the equipment.

The module must be installed and used in accordance with the Hill-Rom user and installation instructions. Hill-Rom is not responsible for any radio or television interference caused by unauthorized modification of the devices included with the Hill-Rom module, or the substitution or attachment of connection cables and equipment other than that specified by Hill-Rom Co., Inc. The correction of interference caused by such unauthorized modification, substitution, or attachment is the responsibility of the user. Hill-Rom is not liable for any damage or violation of government regulations that may arise from the user failing to comply with these requirements.

USA—Federal Communications Commission (FCC) Radiation Exposure Statement



CAUTION:

Caution—The radiated output power of the module is below the FCC radio frequency exposure limits. The module must be used in such a manner that the potential for human contact during normal operation is minimized. To avoid the possibility to exceed the FCC radio frequency exposure limits, you should keep a distance of at least 8" (20 cm) between you (or any other person in the vicinity) and the antenna that is built into the wireless module.

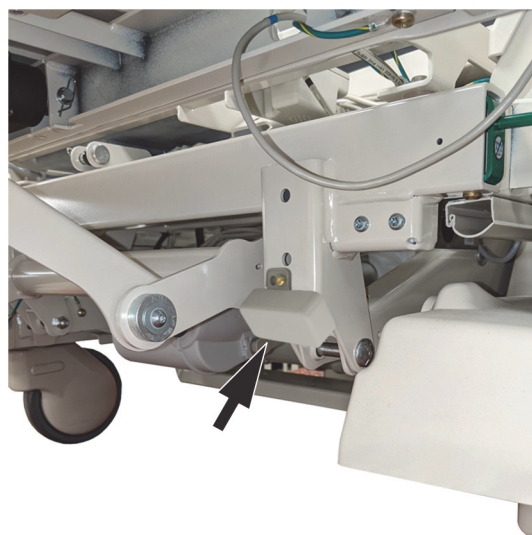

Interference Statement for FCC

NOTE:

"Harmful interference" is defined by the FCC as follows: Any emission, radiation or induction that endangers the functioning of a radio navigation service or of other safety services or seriously degrades, obstructs, or repeatedly interrupts a radio communications service operating in accordance with FCC rules.

These devices comply with Part 15 of the FCC Rules. Operation of the devices is subject to these two conditions: (1) the devices may not cause harmful interference, and (2) the devices must accept any interference that may cause unwanted operation.

This equipment has been tested and found to comply with the limits for a Class A digital device, pursuant to Part 15 of the FCC Rules. These limits are designed to supply reasonable protection against harmful interference in a residential installation. This equipment generates, uses, and can radiate radio frequency energy. If the equipment is not installed and used in accordance with the instructions, the equipment may cause harmful interference to radio communications. There is no guarantee, however, that such interference will not occur in a particular installation. If this equipment does cause harmful interference to radio or television reception (which can be determined by turning the equipment off and on), the user is encouraged to take one of these measures to try to correct the interference:

- Move this device.
- Increase the separation between the device and the receiver.
- Connect the device to an outlet on a circuit different from that of other electronics.
- Consult the dealer or an experienced radio technician for help.

NOTE:

The module must be installed and used in strict accordance with the manufacturer's instructions as described in the user documentation that comes with the product. Any other installation or use will violate FCC Part 15 regulations. Modifications not expressly approved by Hill-Rom could void your authority to operate the equipment.

The module must not be co-located or operated in conjunction with any other antenna or transmitter.

Canada—Industry Canada (IC)

RF Radiation Hazard Warning

This device complies with RSS-247 of Industry Canada.

Operation is subject to these two conditions: (1) this device may not cause interference, and (2) this device must accept any interference, which include interference that may cause unwanted operation of this device.

The term "IC" before the equipment certification number only signifies that the Industry Canada technical specifications were met.

To prevent radio interference to the licensed service, this device is intended to be operated indoors and away from windows to provide maximum shielding. Equipment (or its transmit antenna) that is installed outdoors is subject to licensing.



CAUTION:

Caution—Exposure to Radio Frequency Radiation.

The installer of this radio equipment must make sure the antenna is located or pointed such that it does not emit an RF field in excess of Health Canada limits for the general population; consult Safety Code 6, obtainable from Health Canada's website <http://www.hc-sc.gc.ca/rpb>.

Using higher gain antennas and types of antennas not certified for use with this product is not allowed. The device shall not be co-located with another transmitter.

PRODUCT CONFIGURATION IDENTIFICATION

P7500A BEDS WITH A P7520A SURFACE

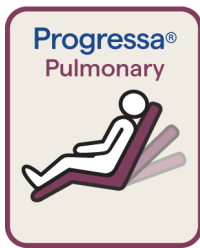

Burgundy border label Pulmonary Surface Dining Chair



Blue border label Therapy Surface Dining Chair



Borderless label Prevention Surface Dining Chair

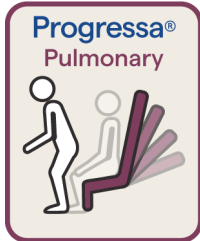

Burgundy border label Pulmonary Surface Chair Egress



Blue border label Therapy Surface Chair Egress



Borderless label Prevention Surface Chair Egress

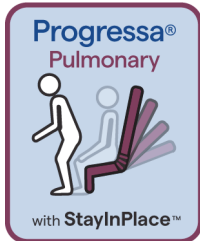

Burgundy border label Pulmonary Surface Chair Egress StayInPlace Feature



Blue border label Therapy Surface Chair Egress StayInPlace Feature



Borderless label Prevention Surface Chair Egress StayInPlace Feature

P7500A BED WITH A P7540A SURFACE



WARNING:





Warning—Do not use a **Progressa+** Xtend (wide) surface with a **Progressa** Bed (P7500A). To do so could cause patient injury or equipment damage.



NOTE:





Do not use a **Progressa+** P7540 surface on any **Progressa** P7500A bed unless the Surface Upgrade Kit (P7541A01 or P7541A02) has been completed and the compatible P7540A surface has been selected from the Instructions provided with the upgrade kit.

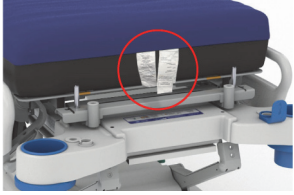

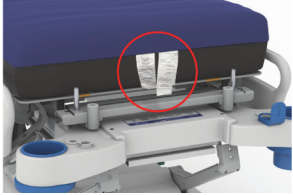

Product Number	Revision	Options	Digit Code
P7540	A	XXXXXXX	
		Digit 7 =Xtend feature (40" surface width)	0:No/1:Yes
		Digit 8 = StayInPlace feature	0:No/1:Yes
		Digit 9 = Pulmonary Therapy Mode	0:no/1:CLRT only/ 2:CLRT and P&V
		Digit 10 = Alternating Low Pressure modesure distribution mode	0:No/1:Yes
		Digit 11 = Rental option	0:No/R:Yes
		Digit 12-13 = 0 (unused)	

Accelerate Surface

Frame	Compatible Surface Product Numbers (See the surface product label at the head end of the surface).
	
 <p>Dining Chair</p>	P7540A0010000
	P7540A0020000
	P7540A0011000
	P7540A0021000
 <p>Chair Egress</p>	P7540A0010000
	P7540A0020000
	P7540A0011000
	P7540A0021000

Accelerate Surface	
<p>Frame</p> 	<p>Compatible Surface Product Numbers (See the surface product label at the head end of the surface.)</p> 
 <p>Chair Egress with StayInPlace Feature</p>	P7540A 0110000
	P7540A 0120000
	P7540A 0111000
	P7540A 0121000

Advance Surface	
<p>Frame</p> 	<p>Compatible Surface Product Numbers (See the surface product label at the head end of the surface.)</p> 
 <p>Dining Chair</p>	P7540A 0000000
	P7540A 0001000
 <p>Chair Egress</p>	P7540A 0000000
	P7540A 0001000
 <p>Chair Egress with StayInPlace Feature</p>	P7540A 0100000
	P7540A 0101000

Essential Surfaces	
<p style="text-align: center;">Frame</p> 	<p style="text-align: center;">Compatible Surface Product Numbers (See the surface product label at the head end of the surface.)</p> 
<div style="text-align: center;">  <p>Dining Chair</p> </div>	<p>P7525A1</p>
<div style="text-align: center;">  <p>Chair Egress</p> </div>	<p>P7525A1</p>
<div style="text-align: center;">  <p>Chair Egress with StayInPlace Feature</p> </div>	<p>P7525A1</p>

Other Surfaces



WARNING:

Warning—The Envision E700 surface on the **Progressa** Bed narrow frame is not fully compliant to the IEC 60601-2-52:2009 standard; however, it is compliant with the FDA Guidance: Hospital Bed System Dimensional and Assessment Guidance to Reduced Entrapment [Issued March 10, 2006] standard. Use of a surface in combination with the product that is not fully compliant to the IEC 60601-2-52:2009 standard may increase the risk of patients becoming trapped. In such cases, the patient must be monitored closely. The Envision E700 is **only** compatible with the narrow **Progressa+** Bed frame.





WARNING:

Warning—The following surfaces can be used with the **Progressa** Bed (narrow bed frame **only**) with the Dining Chair feature option. Do not use the following surfaces with the StayInPlace option. Do not use the **FlexAfoot** feature with the following surfaces (see **Progressa** and **Progressa+** Service Manual (171748) for instructions to disable the air surface (if applicable) and Chair Egress):

- P500 MRS
- NP100—flat deck 36" x 84" (91 cm x 213 cm)
- **AccuMax** Surface—flat deck 36" x 84" (91 cm x 213 cm)
- **Accella** Therapy **MCM** P006788A—flat deck 36" x 84" (91 cm x 213 cm)

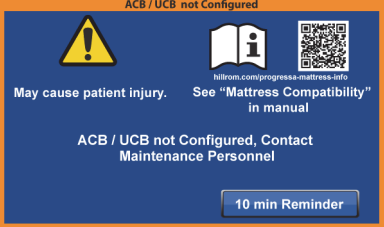
MATTRESS CONNECTION TROUBLESHOOTING

Message	Problem	Solution
	<p>Not Compatible Mattress— Not all Progressa+ Air Mattresses will operate on some Progressa bed frames. For example—</p> <ul style="list-style-type: none"> • A wide (Xtend) Progressa+ mattress will not operate on a narrow Progressa bed frame. • A StayInPlace mattress will not operate on a non-StayInPlace bed frame. 	<p>Install a mattress that is compatible with the bed. See “P7500A Bed with a P7540A Surface” on page 130.</p> <p>NOTE: If the correct mattress is installed and this error shows, contact the facility maintenance department for assistance.</p>
	<p>ACB/UCB not Configured— The air control board (ACB) or the upper control board (UCB) is not properly configured.</p>	<p>Contact your facility maintenance person.</p>

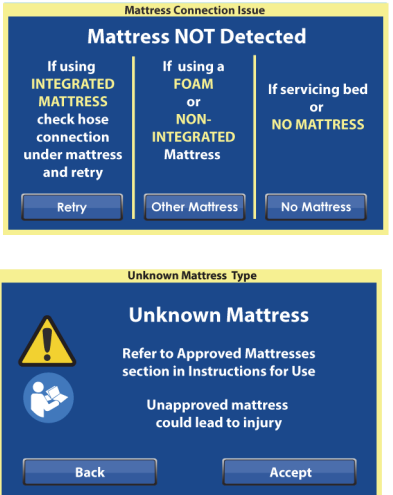
Message	Problem	Solution
	<p>Mattress Issue—Some Progressa+ air mattresses operate on multiple types of Progressa bed frames. However, all of the mattress functions may not be available.</p> <p>For example—</p> <ul style="list-style-type: none"> A Progressa+ Accelerate mattress will connect to a Progressa Therapy bed frame, but the GCI screen will not display the pulmonary features (Rotation and P&V) on the menu. 	<p>Do as applicable:</p> <ul style="list-style-type: none"> Replace the mattress with the correct mattress. See “P7500A Bed with a P7540A Surface” on page 130. To use the current mattress, select No by Remind me. This prevents the message from showing each time the bed with the current mattress is plugged in. Then press Accept.
	<p>Mattress Connection Issue—The bed frame does not detect the mattress.</p> <p>If an integrated air mattress is installed, the mattress hose under the mattress may not be connected to the bed.</p>	<p>Do as applicable:</p> <ul style="list-style-type: none"> If an integrated air mattress is installed, make sure the hose on the underside of the mattress is fully connected to the bed frame. After the connection is made, press Retry on the screen, and follow the on-screen directions. If a foam mattress or a non-integrated mattress is installed, press Other Mattress on the screen. Press Accept on the following screen, if using an approved mattress. If the mattress was removed or disconnected, press No Mattress on the screen to clear the error screen.

Baxter